

UPC-Plus

Maker Board

User's Manual 4th Ed

Copyright Notice

This document is copyrighted, 2019. All rights are reserved. The original manufacturer reserves the right to make improvements to the products described in this manual at any time without notice.

No part of this manual may be reproduced, copied, translated, or transmitted in any form or by any means without the prior written permission of the original manufacturer. Information provided in this manual is intended to be accurate and reliable. However, the original manufacturer assumes no responsibility for its use, or for any infringements upon the rights of third parties that may result from its use.

The material in this document is for product information only and is subject to change without notice. While reasonable efforts have been made in the preparation of this document to assure its accuracy, AAEMON assumes no liabilities resulting from errors or omissions in this document, or from the use of the information contained herein.

AAEMON reserves the right to make changes in the product design without notice to its users.

Acknowledgement

All other products' name or trademarks are properties of their respective owners.

- Microsoft Windows is a registered trademark of Microsoft Corp.
- Intel, Pentium, Celeron, and Xeon are registered trademarks of Intel Corporation
- Core, Atom are trademarks of Intel Corporation
- ITE is a trademark of Integrated Technology Express, Inc.
- IBM, PC/AT, PS/2, and VGA are trademarks of International Business Machines Corporation.

All other product names or trademarks are properties of their respective owners.

Packing List

Before setting up your product, please make sure the following items have been shipped:

Item	Quantity
● UPC-Plus	1

If any of these items are missing or damaged, please contact your distributor or sales representative immediately.

About this Document

This User's Manual contains all the essential information, such as detailed descriptions and explanations on the product's hardware and software features (if any), its specifications, dimensions, jumper/connector settings/definitions, and driver installation instructions (if any), to facilitate users in setting up their product.

Users may refer to the AAEON.com for the latest version of this document.

Safety Precautions

Please read the following safety instructions carefully. It is advised that you keep this manual for future references

1. All cautions and warnings on the device should be noted.
2. Make sure the power source matches the power rating of the device.
3. Position the power cord so that people cannot step on it. Do not place anything over the power cord.
4. Always completely disconnect the power before working on the system's hardware.
5. No connections should be made when the system is powered as a sudden rush of power may damage sensitive electronic components.
6. If the device is not to be used for a long time, disconnect it from the power supply to avoid damage by transient over-voltage.
7. Always disconnect this device from any AC supply before cleaning.
8. While cleaning, use a damp cloth instead of liquid or spray detergents.
9. Make sure the device is installed near a power outlet and is easily accessible.
10. Keep this device away from humidity.
11. Place the device on a solid surface during installation to prevent falls
12. Do not cover the openings on the device to ensure optimal heat dissipation.
13. Watch out for high temperatures when the system is running.
14. Do not touch the heat sink or heat spreader when the system is running
15. Never pour any liquid into the openings. This could cause fire or electric shock.
16. As most electronic components are sensitive to static electrical charge, be sure to ground yourself to prevent static charge when installing the internal components. Use a grounding wrist strap and contain all electronic components in any static-shielded containers.

17. If any of the following situations arises, please contact our service personnel:
 - i. Damaged power cord or plug
 - ii. Liquid intrusion to the device
 - iii. Exposure to moisture
 - iv. Device is not working as expected or in a manner as described in this manual
 - v. The device is dropped or damaged
 - vi. Any obvious signs of damage displayed on the device
18. **DO NOT LEAVE THIS DEVICE IN AN UNCONTROLLED ENVIRONMENT WITH TEMPERATURES BEYOND THE DEVICE'S PERMITTED STORAGE TEMPERATURES (SEE CHAPTER 1) TO PREVENT DAMAGE.**

FCC Statement

This equipment has been tested and found to comply with the limits for a Class B digital device, pursuant to part 15 of the FCC Rules. These limits are designed to provide reasonable protection against harmful interference in a residential installation. This equipment generates, uses and can radiate radio frequency energy and, if not installed and used in accordance with the instructions, may cause harmful interference to radio communications. However, there is no guarantee that interference will not occur in a particular installation. If this equipment does cause harmful interference to radio or television reception, which can be determined by turning the equipment off and on, the user is encouraged to try to correct the interference by one or more of the following measures:

- Reorient or relocate the receiving antenna.
 - Increase the separation between the equipment and receiver.
 - Connect the equipment into an outlet on a circuit different from that to which the receiver is connected.
 - Consult the dealer or an experienced radio/TV technician for help.
-
- Any changes or modifications not expressly approved by the party responsible for compliance could void the authority to operate equipment.
 - This device and its antenna must not be co-located or operating in conjunction with any other antenna or transmitter.
 - End-users and installers must be provided with antenna installation instructions and transmitter operating conditions for satisfying RF exposure compliance.

This equipment complies with FCC radiation exposure limits set forth for an uncontrolled environment. This equipment should be installed and operated with minimum distance 20cm between the radiator & your body.

This device complies with Part 15 of FCC rules. Operation is subject to the following two conditions: (1) this device may not cause harmful interference and (2) this device must accept any interference received, including interference that may cause undesired operation.

China RoHS Requirements (CN)

产品中有毒有害物质或元素名称及含量

AAEON Main Board/ Daughter Board/ Backplane

部件名称	有毒有害物质或元素					
	铅 (Pb)	汞 (Hg)	镉 (Cd)	六价铬 (Cr(VI))	多溴联苯 (PBB)	多溴二苯醚 (PBDE)
印刷电路板 及其电子组件	○	○	○	○	○	○
外部信号 连接器及线材	○	○	○	○	○	○
<p>O: 表示该有毒有害物质在该部件所有均质材料中的含量均在 SJ/T 11363-2006 标准规定的限量要求以下。</p> <p>X: 表示该有毒有害物质至少在该部件的某一均质材料中的含量超出 SJ/T 11363-2006 标准规定的限量要求。</p> <p>备注: 此产品所标示之环保使用期限, 系指在一般正常使用状况下。</p>						

China RoHS Requirement (EN)

Poisonous or Hazardous Substances or Elements in Products

AAEON Main Board/ Daughter Board/ Backplane

Component	Poisonous or Hazardous Substances or Elements					
	Lead (Pb)	Mercury (Hg)	Cadmium (Cd)	Hexavalent Chromium (Cr(VI))	Polybrominated Biphenyls (PBB)	Polybrominated Diphenyl Ethers (PBDE)
PCB & Other Components	○	○	○	○	○	○
Wires & Connectors for External Connections	○	○	○	○	○	○
<p>O: The quantity of poisonous or hazardous substances or elements found in each of the component's parts is below the SJ/T 11363-2006-stipulated requirement.</p> <p>X: The quantity of poisonous or hazardous substances or elements found in at least one of the component's parts is beyond the SJ/T 11363-2006-stipulated requirement.</p> <p>Note: The Environment Friendly Use Period as labeled on this product is applicable under normal usage only</p>						

Table of Contents

Chapter 1 - Product Specifications	1
1.1 Specifications	2
Chapter 2 – Hardware Information	5
2.1 Dimensions	6
2.2 Jumpers and Connectors.....	7
2.3 List of Switches and Connectors.....	8
2.3.1 Power Button (SW1).....	10
2.3.2 Fan (CN1)	10
2.3.3 Internal USB UART (CN2)	11
2.3.4 eDP (CN3)	12
2.3.5 BIOS PROGRAM (CN4).....	13
2.3.6 RTC (CN5).....	13
2.3.7 USB 3.0 (CN6).....	14
2.3.8 DP Connector (CN7)	14
2.3.9 Power Input (CN8).....	15
2.3.10 Micro USB3.0 (CN9)	16
2.3.11 DOCKING I (CN10).....	16
2.3.12 MIPI CSI (CN11).....	19
2.3.13 DOCKING II (CN12).....	20
2.3.14 MIPI CSI 2CH (CN13).....	22
2.3.15 PWR Button Pin Header (CN14)	23
Chapter 3 – Drivers Installation	24
3.1 Driver Download and Installation.....	25

Chapter 1

Product Specifications

1.1 Specifications

System

- **CPU/Chipset** Intel® Apollo Lake SoC E3930/E3940/E3950
- **Memory** Onboard Single/Dual Channel LPDDR4 memory, Max 8GB
- **Graphics** Intel® HD Graphics
1x DP
1x Full eDP
- **Storage** 1x eMMC ver 5.0 (32GB/64GB/128GB)
- **WiFi/BT** Onboard WIFI 802.11 a/b/g/n/ac + BT 4.2
- **Audio** 1xDP
- **MIPI CSI** Support simultaneous display
1x MIPI-CSI 2 Channel connector
1x MIPI-CSI 4 Channel connector
- **USB** 1x USB 3.0
1x USB 3OTG
2x USB 2.0 (Pin header)
- **Expansion HAT (100 pin)** Docking Connector 1 100 pin:
 1. 5V, GND
 2. Original HAT 40pin interface with MAX10 (GPIOx28, I2Cx2, SPIx1, HSUART1x1, ADCx1, 5V, GND)
 3. PCIe1 (Optional USB 3.0)
 4. USB2.0x1
 5. LPC

System

- **Expansion HAT (100 pin)**
 - Docking Connector 2 100 pin:
 1. 12V, GND
 2. DDIx1 (for 3rd display on HDMI / DP)
 3. 3x PCIe1
 4. 2x PCIe1 or USB3.0
 5. 1xSATA1 or USB 3.0
 6. 1x SATA0
 7. 3xUSB2.0

I/O

- **Internal I/O Connectors**
 - 1x eDP with Backlight control Header
 - 1x CSI 2 Lane Header
 - 1x CSI 4 Lane Header
 - 1x 10 pin USB2.0
 - 1x 2 pin Fan connector
 - 1x RTC Pin Header
 - 1x Power Button header
 - 1x Reset Pin header
 - 2x 100 pin Docking Connector
 - 2x Antenna Headers
- **External I/O Connectors**
 - 1x DP Connector
 - 1x USB 3.0 single Connector
 - 1x USB 3.0 OTG Connector
 - 1x Power Button
 - 1x DC connector

Others

- **Power** 12V DC in
- **Form Factor** 90 mm × 56 mm
- **Operating Temperature** 0°C -60°C
- **Operating Humidity** 0% ~ 90% relative humidity, non-condensing
- **Certification** CE,FCC Class B
- **OS Support**
Windows 10
Linux (UbiLinux, Ubuntu, Yocto)
Android IA 9.0

Chapter 2

Hardware Information

2.1 Dimensions

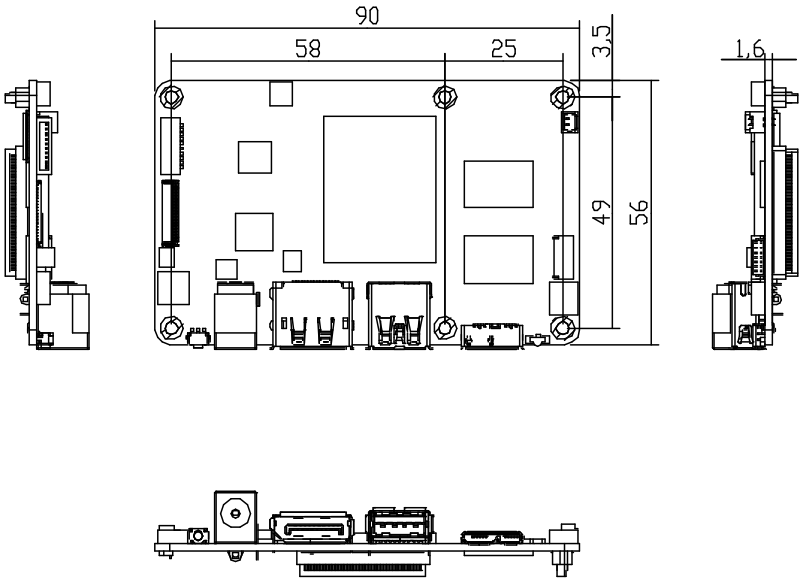

2.2 Jumpers and Connectors

Top side

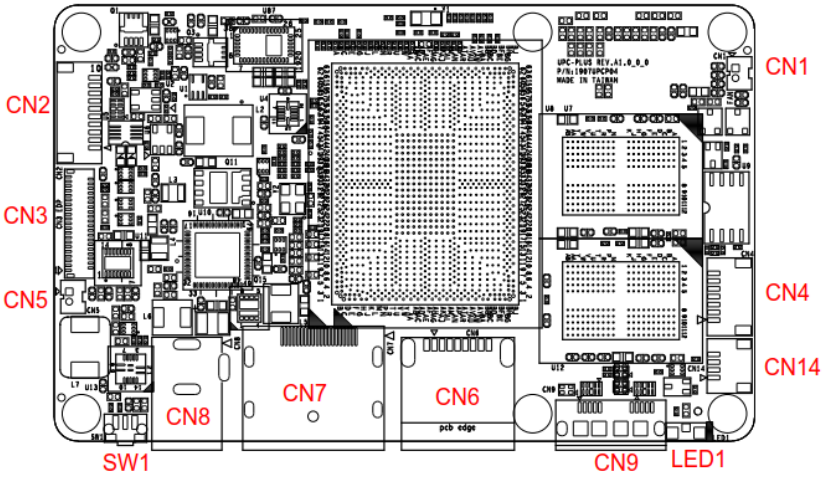

Bottom side

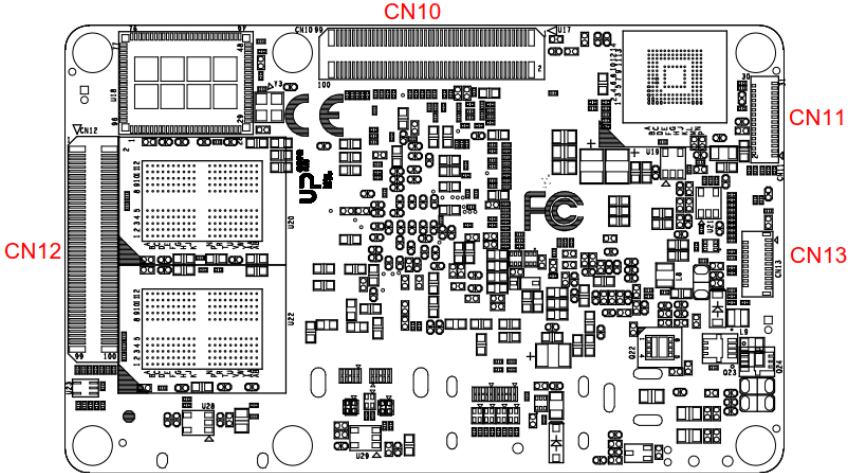

2.3 List of Switches and Connectors

Please refer to the table below for all of the board's jumpers that you can configure for your application

Reference	Function	Connector Type
SW1	PWR button	(TF)Push Button Switch.3P.12VDC.50mA.500mohm.Black.SMD.HCH.PTS-099
CN1	FAN	(TF)WAFER BOX.2P.180D(M).DIP.1.25mm.PINREX.712-71-02TW01
CN2	Internal USB UART	(TF)Wafer Box.10P.90D(M).SMD.1.0mm.PINREX.710-74-10TWR6
CN3	eDP	(TF)FPC/FFC Conn.41P.90D(F).SMD.0.6mm.Hirose.FH35C-41S-0.3SH W(50)
CN4	BIOS PROGRAM	(TF)WAFER BOX.7P.180D(M).SMD.1.0mm.W/Cap.PINREX.710-73-07 TWE6
CN5	RTC	(TF)WAFER BOX.2P.180D(M).DIP.1.25mm.PINREX.712-71-02TW01
CN6	USB3.0	(TF)USB3.0 Connector.Single Port.Type A.9P.90D(F).SMD.Trontek.930-00406-A91-21
CN7	DP	(TF)DisplayPort CON.20P.90D.(F).SMD.FOXCONN.3VD51203-D7JJ-7H
CN8	Power Input	(TF)DC Power Jack.3P.90D(M).DIP.2.0mm.COXOC.416AEWTJ02004PA
CN9	Micro USB3.0	(TF)Micro USB 3.0 Conn..10P.90D(M).SMD.B-type.ATTEND.209E-BE01

Reference	Function	Connector Type
CN10	DOCKING I	(TF)Board-Board Connector:100P180D(M).Pitch=0.5mm.H=5.3mm.SMD. Panasonic.AXK6S00647YG
CN11	MIPI CSI	(TF)FPC/FFC Conn..31P90D(F).SMD.0.3mm.Dual Contact.Panasonic.AYF333135
CN12	DOCKING II	(TF)Board-Board Connector:100P180D(M).Pitch=0.5mm.H=5.3mm.SMD. Panasonic.AXK6S00647YG
CN13	MIPI CSI 2CH	(TF)FPC/FFC Conn.21P90D(F).SMD.0.6mm.Hirose.FH35C-21S-0.3SH W(50)
CN14	PWR Button Pin Header	(TF)WAFER BOX.2P90D(M).SMD.1.0mm.W/Cap.PINREX.710-74-02T WR6
LED1	SYSTEM Indicator	(TF)LED.3.0*1.0*1.0mm. Blue.SMD.LITEON. LTST-S320TBKT

2.3.1 Power Button (SW1)

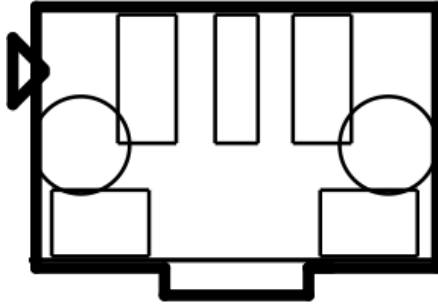

Pin	Signal	Pin	Signal
1	GND	2	PMU_PWRBTN_N
3	GND		

2.3.2 Fan (CN1)

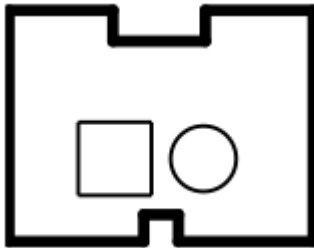

Pin	Signal Description	Pin	Signal Description
1	FAN_PWR(5V)	2	GND

2.3.3 Internal USB UART (CN2)

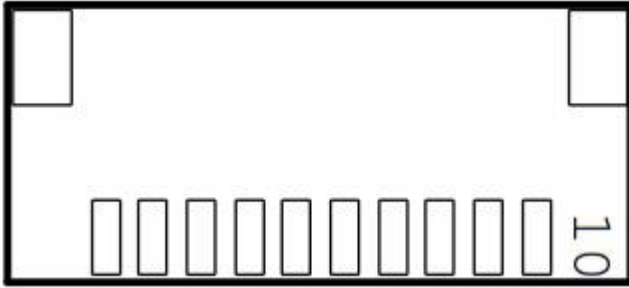

Pin	Signal	Pin	Signal
1	+5V	2	USB2_DN6
3	USB2_DP6	4	GND
5	+5V	6	USB2_DN7
7	USB2_DP7	8	GND
9	UART0_RXD_3V3	10	UART0_TXD_3V3

2.3.4 eDP (CN3)

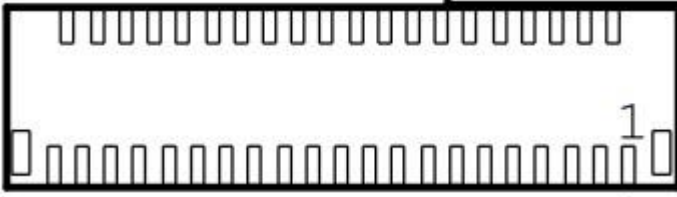

Pin	Signal	Pin	Signal
1	NC	2	NC
3	GND	4	NC
5	NC	6	GND
7	NC	8	NC
9	GND	10	NC
11	NC	12	GND
13	NC	14	NC
15	GND	16	EDP_TXP_0
17	EDP_TXN_0	18	GND
19	EDP_TXP_1	20	EDP_TXN_1
21	GND	22	EDP_TXP_2
23	EDP_TXN_2	24	GND
25	EDP_TXP_3	26	EDP_TXN_3
27	GND	28	EDP_AUXP
29	EDP_AUXN	30	GND
31	EDP_HPDCONN	32	DDIO_BKLT_CTRL
33	DDIO_VDD_EN	34	DDIO_BKLT_EN
35	I2C_3V3_SCL7	36	I2C_3V3_SDA7
37	+3.3V	38	+3.3V
39	+3.3V	40	+3.3V
41	+3.3V		

2.3.5 BIOS PROGRAM (CN4)

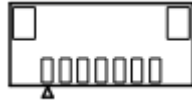

Pin	Signal	Pin	Signal
1	SPI_MISO	2	GND
3	SPI_CLK	4	+VCC_SPI
5	SPI_MOSI	6	SPI_CS0#
7	NC		

2.3.6 RTC (CN5)

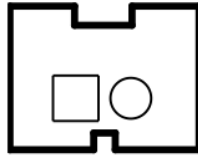

Pin	Signal	Pin	Signal
1	RTC_VCC	2	GND

2.3.7 USB 3.0 (CN6)

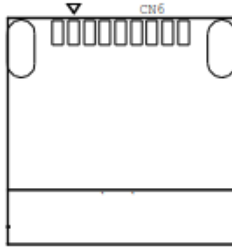

Pin	Signal	Pin	Signal
1	+V5P0_USB_1	2	USB2_C_DN1
3	USB2_C_DP1	4	GND
5	USB3_RXN_CON_P1	6	USB3_RXP_CON_P1
7	GND	8	USB3_TXN_CON_P1
9	USB3_TXP_CON_P1		

2.3.8 DP Connector (CN7)

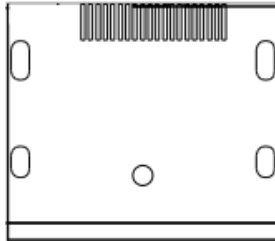

Pin	Signal	Pin	Signal
1	DDI1_TXP_DP_0	2	GND
3	DDI1_TXN_DP_0	4	DDI1_TXP_DP_1
5	GND	6	DDI1_TXN_DP_1
7	DDI1_TXP_DP_2	8	GND
9	DDI1_TXN_DP_2	10	DDI1_TXP_DP_3

Pin	Signal	Pin	Signal
11	GND	12	DDI1_TXN_DP_3
13	GND	14	GND
15	DDI1_AUXP_C	16	GND
17	DDI1_AUXN_C	18	DDI1_HPD
19	GND	20	+3.3V

2.3.9 Power Input (CN8)

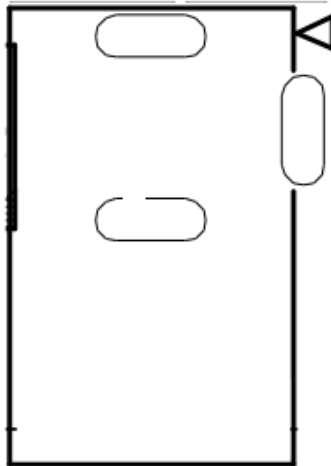

Pin	Signal	Pin	Signal
1	+12V	2	GND
3	GND		

2.3.10 Micro USB3.0 (CN9)

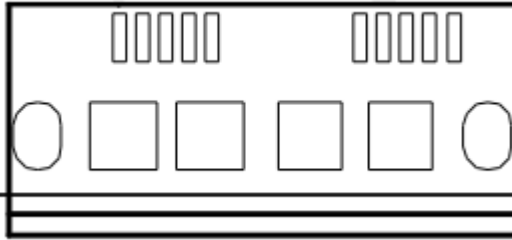

Pin	Signal	Pin	Signal
1	+V5P0_USB_OTG	2	USB2_C_DN0
3	USB2_C_DP0	4	USB_OTG_R_ID
5	GND	6	USB3_RXN_CON_P0
7	USB3_RXP_CON_P0	8	GND
9	USB3_TXN_CON_P0	10	USB3_TXP_CON_P0

2.3.11 DOCKING I (CN10)

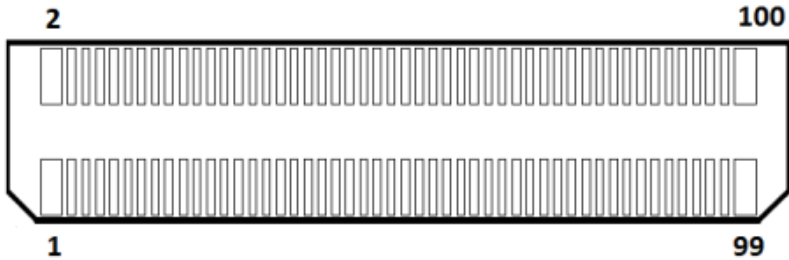

Pin	Signal	Signal Level	Pin	Signal	Signal Level
1	+V5A		2	+V5A	
3	+V5A		4	+V5A	
5	+V5A		6	+V5A	
7	+V5A		8	+V5A	
9	GND		10	GND	

Pin	Signal	Signal Level	Pin	Signal	Signal Level
11	PMU_PLT_RST#	3.3V,PU10K	12	LPSS_UART1_RTS	1.8V,PU10K
13	PMU_PWRBTN_N	3.3V,PU10K	14	LPSS_UART1_CTS	1.8V
15	PM_SLP_S3#_3P3	3.3V	16	LPSS_UART1_TXD	1.8V,PD10K
17	PCIE_CLKREQ3#	1.8V,PU10K	18	LPSS_UART1_RXD	1.8V
19	PCIE_WAKE3_N	1.8V,PU4.7K	20	GND	
21	GND		22	CPU_prog_JTAG_TDO	1.8V
23	SIO_SPI_0_TXD	1.8V,PU10K	24	CPU_prog_JTAG_TMS	1.8V
25	SIO_SPI_0_RXD	1.8V	26	HDMI1_CEC_D	1.8V,PU27K
27	SIO_SPI_0_CLK	1.8V,PD10K	28	CPU_prog_JTAG_TCK	1.8V
29	SIO_SPI_0_FS0	1.8V,PD10K	30	CPU_prog_JTAG_TDI	1.8V
31	SIO_SPI_0_FS1	1.8V,PU10K	32	ISH_GPIO_0	1.8V
33	GND		34	ISH_GPIO_1	1.8V
35	LPC_R_AD0	1.8V	36	ISH_GPIO_2	1.8V
37	LPC_R_AD1	1.8V	38	ISH_GPIO_3	1.8V
39	LPC_R_AD2	1.8V	40	ISH_GPIO_4	1.8V
41	LPC_R_AD3	1.8V,PU10K	42	ISH_GPIO_5	1.8V
43	GND		44	ISH_GPIO_6	1.8V
45	AVS_I2S2_MCLK	1.8V	46	PWM0	1.8V,PD10K
47	AVS_I2S2_WS_SYNC	1.8V	48	PWM1	1.8V,PD10K
49	AVS_I2S2_SDI	1.8V	50	GND	
51	AVS_I2S2_SDO	1.8V,PD4.7K	52	I2C_SDA6	1.8V,PU10K
53	GND		54	I2C_SCL6	1.8V,PU10K
55	PCIE_P5_USB3_P2_TXP		56	GND	
57	PCIE_P5_USB3_P2_TXN		58	AVS_I2S2_BCLK	1.8V
59	GND		60	BT_HOST_WAKE	1.8V
61	PCIE_P5_USB3_P2_RXP		62	GND	
63	PCIE_P5_USB3_P2_RXN		64	USB2_DP2	

Pin	Signal	Signal Level	Pin	Signal	Signal Level
65	GND		66	USB2_DN2	
67	PCIE_REFCLK3_P		68	GND	
69	PCIE_REFCLK3_N		70	nSTATUS	1.8V
71	GND		72	GND	
73	I2C_SDA0	1.8V,PU10K	74	ISH_GPIO_7	1.8V
75	I2C_SCL0	1.8V,PU10K	76	ISH_GPIO_8	1.8V
77	GND		78	ISH_GPIO_9	1.8V
79	I2C_SDA1	1.8V,PU10K	80	ISH_GPIO_10	1.8V
81	I2C_SCL1	1.8V,PU10K	82	ISH_GPIO_11	1.8V
83	GND		84	ISH_GPIO_12	1.8V
85	GPIO_2	1.8V	86	ISH_GPIO_13	1.8V
87	GPIO_3	1.8V	88	ISH_GPIO_14	1.8V
89	GND		90	PMIC_IRQ_N	1.8V
91	LPC_FRAME_N	1.8V	92	FPGA_CLR	1.8V
93	LPC_R_CLKOUT0	1.8V	94	GND	
95	LPC_CLKRU_N	1.8V	96	GPIO217/FPGA_OE	1.8V
97	LPC_SERIRQ	1.8V	98	GPIO216/FPGA_RST	1.8V
99	CONFIG_SEL	1.8V	10	FPGA_fw_reload	1.8V

2.3.12 MIPI CSI (CN11)

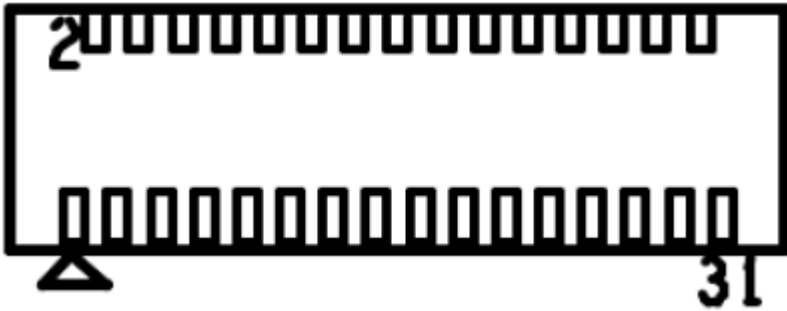

Pin	Signal	Pin	Signal
1	GND	2	CAM1_RST_N
3	NC	4	I2C_SDA4
5	I2C_SCL4	6	GND
7	OSC_CLK_OUT_2	8	GND
9	MCSI_RX_DATAN_0	10	MCSI_RX_DATAP_0
11	GND	12	MCSI_RX_DATAN_1
13	MCSI_RX_DATAP_1	14	GND
15	MCSI_RX_CLKN_0	16	MCSI_RX_CLKP_0
17	GND	18	MCSI_RX_DATAN_2
19	MCSI_RX_DATAP_2	20	GND
21	MCSI_RX_DATAN_3	22	MCSI_RX_DATAP_3
23	GND	24	+AVDD_CAM
25	GND_CAM	26	+VIP2_CAM
27	+VIP8_CAM	28	GND
29	+V2P8_CAM	30	+V2P8_CAM
31	GND		

2.3.13 DOCKING II (CN12)

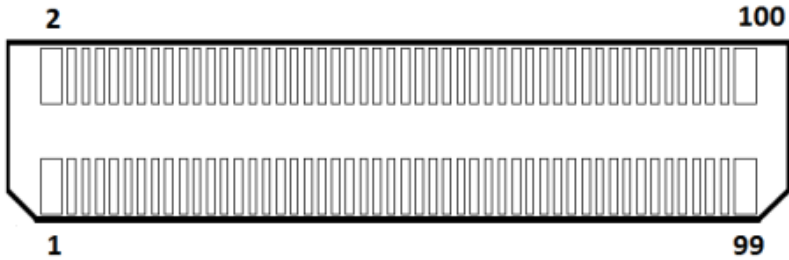

Pin	Signal	Signal Level	Pin	Signal	Signal Level
1	+12V		2	+12V	
3	+12V		4	+12V	
5	+12V		6	+12V	
7	+12V		8	+12V	
9	NC		10	NC	
11	DDIO_HPD		12	GND	
13	DDIO_TXP_1		14	DDIO_TXP_0	
15	DDIO_TXN_1		16	DDIO_TXN_0	
17	GND		18	GND	
19	DDIO_TXP_2		20	DDIO_TXP_3	
21	DDIO_TXN_2		22	DDIO_TXN_3	
23	GND		24	GND	
25	DDIO_AUXP		26	DDIO_DDCCLK	
27	DDIO_AUXN		28	DDIO_DDCDATA	
29	GND		30	GND	
31	PCIE_REFCLK0_P		32	PCIE_REFCLK1_P	
33	PCIE_REFCLK0_N		34	PCIE_REFCLK1_N	
35	GND		36	GND	
37	PCIE_RXP0		38	PCIE_RXP1	

Pin	Signal	Signal Level	Pin	Signal	Signal Level
39	PCIE_RXN0		40	PCIE_RXN1	
41	GND		42	GND	
43	PCIE_TXP0		44	PCIE_TXP1	
45	PCIE_TXN0		46	PCIE_TXN1	
47	GND		48	GND	
49	PCIE_REFCLK2_P		50	PCIE_P3_USB3_P4_TXP	
51	PCIE_REFCLK2_N		52	PCIE_P3_USB3_P4_TXN	
53	GND		54	GND	
55	PCIE_TXP2		56	PCIE_P3_USB3_P4_RXP	
57	PCIE_TXN2		58	PCIE_P3_USB3_P4_RXN	
59	GND		60	GND	
61	PCIE_RXP2		62	SATA_P1_USB3_P5_RXN	
63	PCIE_RXN2		64	SATA_P1_USB3_P5_RXP	
65	GND		66	GND	
67	PCIE_P4_USB3_P3_TXP		68	SATA_P1_USB3_P5_TXN	
69	PCIE_P4_USB3_P3_TXN		70	SATA_P1_USB3_P5_TXP	
71	GND		72	GND	
73	PCIE_P4_USB3_P3_RXP		74	SATA_RXN0	
75	PCIE_P4_USB3_P3_RXN		76	SATA_RXP0	
77	GND		78	GND	
79	USB2_DP3		80	SATA_TXP0	
81	USB2_DN3		82	SATA_TXN0	
83	GND		84	GND	
85	USB2_DP4		86	USB2_DP5	
87	USB2_DN4		88	USB2_DN5	
89	GND		90	GND	
91	PWRON/PNLVDDEN	3.3V/PU10K	92	SATA_LED_N	1.8V

Pin	Signal	Signal Level	Pin	Signal	Signal Level
93	PLTRST/PNLBKLEN	3.3V,PU10K	94	DDIO_BKLTCTL	1.8V
95	PCIE_WAKE0_N	1.8V,PU4.7K	96	PCIE_CLKREQ0#	1.8V,PU10K
97	PCIE_WAKE1_N	1.8V,PU4.7K	98	PCIE_CLKREQ1#	1.8V,PU10K
99	PCIE_WAKE2_N	1.8V,PU4.7K	10	PCIE_CLKREQ2#	1.8V,PU10K

2.3.14 MIPI CSI 2CH (CN13)

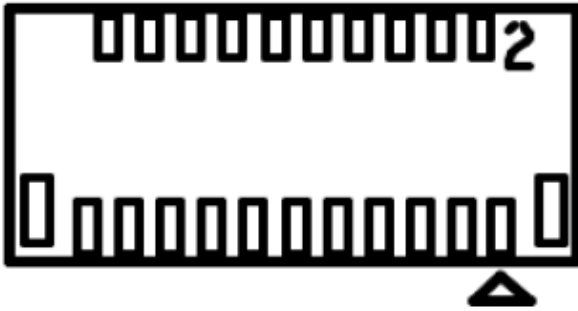

Pin	Signal	Pin	Signal
1	GND	2	MCSI_DN_1
3	MCSI_DP_1	4	GND
5	MCSI_CLKN_0	6	MCSI_CLKP_0
7	GND	8	MCSI_DN_0
9	MCSI_DP_0	10	GND
11	+VIP2_CAM	12	+VIP8_CAM
13	GND	14	OSC_CLK_OUT_3
15	GND	16	I2C_SCL4
17	I2C_SDA4	18	CAM2_RST_N
19	FLASH_RESET_N	20	+V2P8_CAM
21	GND_CAM		

2.3.15 PWR Button Pin Header (CN14)

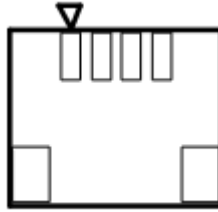

Pin	Signal	Pin	Signal
1	PWRBTN_N	2	GND
3	RSTBTN_N	4	GND

Chapter 3

Drivers Installation

3.1 Driver Download and Installation

**Please access <https://www.up-community.org> and go to the Downloads section to find the relevant driver.*