

**Wide Operating
Temperature**

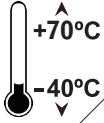

Rigid-750 / Rigid-752

Intel® Core™ i5-520M
Box PC

User's Manual

Version 1.1



P/N: 4016075200110P

2014.11

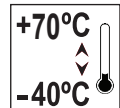

This page is intentionally left blank.

Chapter 1 - General Information	1
1.1 Introduction	2
1.2 Packing List	2
1.3 The Installation Paths of CD Driver	4
1.4 Specifications	4
1.5 Power Information	6
1.6 Dimensions	6
1.7 Locating Controls and Connectors	7
1.8 Connecting Peripherals	9
1.8.1 VGA/DVI/DisplayPort Video Outputs	9
1.8.2 Serial Ports (COM1 ~4)	10
1.8.3 LAN Ports	11
1.8.4 USB Ports	12
1.8.5 Keyboard and Mouse	13
1.8.6 Expansion PCIe Slots	13
1.8.7 Audio Line-out/Mic-in	14
1.8.8 DC Power Input and Power ON/OFF Button	15
Chapter 2 - The Engine of Rigid-750/Rigid-752	17
2.1 Board Layout	18
2.2 Jumpers and Connectors	19
2.2.1 Jumpers & Connectors List	19
2.2.2 Jumper Setting	20
SW1, 2, 4 (RS-232/RS-485 Function Select Jumper for COM3, COM4)	20
SW1 Setting	20
SW2 Setting	21
2.2.3 Pin Assignments for Connectors	21
PWRIN1 (Power Input)	21
SW4 Setting	21
CN1 (COM1 ~ COM4)	22
CBL-7100-COM (COM Converter Cable) (Optional) ...	23
VGA1 (CRT Display Connector)	25
DP1 (DisplayPort Connector)	25
LAN1/2 (LAN Ports)	26
USB1/2 (USB Ports)	26

AUDIO1 (Audio Jacks).....	26
MC1 (PCIe Mini-card socket).....	27
CPUF1/2 (Fan Connector)	28
KBM1 (Keyboard & Mouse).....	28
CF1 (CFast Slot).....	28
DVI1 (DVI).....	30
JSPI1 (System BIOS Enable/ Disable Pin Header, factory use only)	30
DIO1 (Digital I/O Port)	31
LPT1 (Parallel Port).....	31
SATA1/2 (Serial ATA Connectors).....	32
PWR1/2 (HDD/SSD Power Connectors)	32
Chapter 3 - Installation and Maintenance.....	33
3.1 CPU and Memory Module Installation	34
3.1.1 Removing Top Cover.....	34
3.1.2 Installing CPU	35
3.1.3 Installing Memory Module.....	36
3.1.4 Installing Memory Module with Thermal Pad.....	37
3.1.5 Installing HSUPA 3.75G Module	42
3.2 How to Access CFast/SIM Card.....	45
3.3 Hard Disk Drive and PCIe Card Installation	47
3.3.1 Removing Bottom Cover.....	47
3.3.2 Installing Hard Disk Drive	47
3.3.3 Installing PCIe Card.....	51
3.4 Wall Mounting	52
3.5 Grounding the Box PC	53
3.6 Wiring the DC-Input Power Source	54
Chapter 4 - BIOS	55
4.1 BIOS Main Setup.....	56
4.2 Advanced Settings	57
4.2.1 ACPI Settings	59
4.2.2 CPU Configuration.....	60
4.2.3 SATA Configuration	62
4.2.4 Intel® IGD SWSCI OpRegion Configuration.....	63
4.2.5 USB Configuration.....	64
4.2.6 Super IO Configuration	65

- 4.2.7 PC Health Status..... 66
- 4.2.8 Second Super IO Configuration 67
- 4.2.9 Platform Thermal Configuration..... 68
- 4.3 Chipset Settings69
 - 4.3.1 North Bridge..... 70
 - 4.3.2 South Bridge Configuration..... 71
- 4.4 Boot Settings72
- 4.5 Security.....74
- 4.6 Save & Exit76
- Appendix79
 - Appendix A: I/O Port Address Map80
 - Appendix B: Interrupt Request Lines (IRQ)82
 - Appendix C: Memory Mapping83
 - Appendix D: Digital I/O Setting.....85
 - Appendix E: Watchdog Timer (WDT) Setting87

This page is intentionally left blank.

Copyright Notice

All Rights Reserved.

The information in this document is subject to change without prior notice in order to improve the reliability, design and function. It does not represent a commitment on the part of the manufacturer.

Under no circumstances will the manufacturer be liable for any direct, indirect, special, incidental, or consequential damages arising from the use or inability to use the product or documentation, even if advised of the possibility of such damages.

This document contains proprietary information protected by copyright. All rights are reserved. No part of this document may be reproduced by any mechanical, electronic, or other means in any form without prior written permission of the manufacturer.

Declaration of Conformity

CE

The CE symbol on your product indicates that it is in compliance with the directives of the Union European (EU). A Certificate of Compliance is available by contacting Technical Support.

This product has passed the CE test for environmental specifications when shielded cables are used for external wiring. We recommend the use of shielded cables. This kind of cable is available from ARBOR. Please contact your local supplier for ordering information.

<p>Warning</p>

<p>This is a class A product. In a domestic environment this product may cause radio interference in which case the user may be required to take adequate measures.</p>

FCC Class A

This device complies with Part 15 of the FCC Rules. Operation is subject to the following two conditions:

- (1) This device may not cause harmful interference, and
- (2) This device must accept any interference received, including interference that may cause undesired operation.

NOTE:

This equipment has been tested and found to comply with the limits for a Class A digital device, pursuant to Part 15 of the FCC Rules. These limits are designed to provide reasonable protection against harmful interference when the equipment is operated in a commercial environment. This equipment generates, uses, and can radiate radio frequency energy and, if not installed and

used in accordance with the instruction manual, may cause harmful interference to radio communications. Operation of this equipment in a residential area is likely to cause harmful interference in which case the user will be required to correct the interference at his own expense.

RoHS

ARBOR Technology Corp. certifies that all components in its products are in compliance and conform to the European Union's Restriction of Use of Hazardous Substances in Electrical and Electronic Equipment (RoHS) Directive 2002/95/EC.

The above mentioned directive was published on 2/13/2003. The main purpose of the directive is to prohibit the use of lead, mercury, cadmium, hexavalent chromium, polybrominated biphenyls (PBB), and polybrominated diphenyl ethers (PBDE) in electrical and electronic products. Member states of the EU are to enforce by 7/1/2006.

ARBOR Technology Corp. hereby states that the listed products do not contain unintentional additions of lead, mercury, hex chrome, PBB or PBDB that exceed a maximum concentration value of 0.1% by weight or for cadmium exceed 0.01% by weight, per homogenous material. Homogenous material is defined as a substance or mixture of substances with uniform composition (such as solders, resins, plating, etc.). Lead-free solder is used for all terminations (Sn(96-96.5%), Ag(3.0-3.5%) and Cu(0.5%)).

SVHC / REACH

To minimize the environmental impact and take more responsibility to the earth we live, Arbor hereby confirms all products comply with the restriction of SVHC (Substances of Very High Concern) in (EC) 1907/2006 (REACH --Registration, Evaluation, Authorization, and Restriction of Chemicals) regulated by the European Union.

All substances listed in SVHC < 0.1 % by weight (1000 ppm)

Important Safety Instructions

Read these safety instructions carefully

1. Read all cautions and warnings on the equipment.
2. Place this equipment on a reliable surface when installing. Dropping it or letting it fall may cause damage
3. Make sure the correct voltage is connected to the equipment.
4. For pluggable equipment, the socket outlet should be near the equipment and should be easily accessible.
5. Keep this equipment away from humidity.
6. The openings on the enclosure are for air convection and protect the equipment from overheating. **DO NOT COVER THE OPENINGS.**
7. Position the power cord so that people cannot step on it. Do not place anything over the power cord.
8. Never pour any liquid into opening. This may cause fire or electrical shock.
9. Never open the equipment. For safety reasons, the equipment should be opened only by qualified service personnel.
10. If one of the following situations arises, get the equipment checked by service personnel:
 - a. The power cord or plug is damaged.
 - b. Liquid has penetrated into the equipment.
 - c. The equipment has been exposed to moisture.
 - d. The equipment does not work well, or you cannot get it to work according to the user's manual.
 - e. The equipment has been dropped or damaged.
 - f. The equipment has obvious signs of breakage.
11. Keep this User's Manual for later reference.

About This User's Manual

This User's Manual is intended for experienced users and integrators with hardware knowledge of personal computers. If you are not sure about any description in this User's Manual, please consult your vendor before further handling.

Warning

The Box PC and its components contain very delicately Integrated Circuits (IC). To protect the Box PC and its components against damage caused by static electricity, you should always follow the precautions below when handling it:

1. Disconnect your Box PC from the power source when you want to work on the inside.
2. Use a grounded wrist strap when handling computer components.
3. Place components on a grounded antistatic pad or on the bag that came with the Box PC, whenever components are separated from the system.

Replacing the Lithium Battery

Incorrect replacement of the lithium battery may lead to a risk of explosion.

The lithium battery must be replaced with an identical battery or a battery type recommended by the manufacturer.

Do not throw lithium batteries into the trashcan. It must be disposed of in accordance with local regulations concerning special waste.

Technical Support

If you have any technical difficulties, please consult the user's manual first at: <ftp://ftp.arbor.com.tw/pub/manual>

Please do not hesitate to call or e-mail our customer service when you still cannot find out the answer.

<http://www.arbor.com.tw>

E-mail:info@arbor.com.tw

Warranty

This product is warranted to be in good working order for a period of one year from the date of purchase. Should this product fail to be in good working order at any time during this period, we will, at our option, replace or repair it at no additional charge except as set forth in the following terms. This warranty does not apply to products damaged by misuse, modifications, accident or disaster.

Vendor assumes no liability for any damages, lost profits, lost savings or any other incidental or consequential damage resulting from the use, misuse of, or inability to use this product. Vendor will not be liable for any claim made by any other related party.

Vendors disclaim all other warranties, either expressed or implied, including but not limited to implied warranties of merchantability and fitness for a particular purpose, with respect to the hardware, the accompanying product's manual(s) and written materials, and any accompanying hardware. This limited warranty gives you specific legal rights.

Return authorization must be obtained from the vendor before returned merchandise will be accepted. Authorization can be obtained by calling or faxing the vendor and requesting a Return Merchandise Authorization (RMA) number. Returned goods should always be accompanied by a clear problem description.

Ordering Information

Rigid-750	Fanless embedded controller w/ 1 x PCIe x8 slot
Rigid-752	Fanless embedded controller w/ 1 x PCIe x1 slot + 1 x PCIe x16 slot
SSD-25080	Intel® 2.5" 80GB SATA II SSD kit
HSUPA-3500	HSUPA 3.75G module kit
WRK-GB320	WT DDR3 2GB SDRAM DIMM2 kit

This page is intentionally left blank.

Chapter 1

General Information

1.1 Introduction

Both Box PCs, Rigid-750 and Rigid-752, are targeted at many different application fields. By adopting it, you can pinpoint specific markets, such as Thin Client, KIOSK, information booth, GSM Server, environment-critical and space-critical applications.

- **All-In-One Platform**
The CPU, DRAM and even software are integrated to provide a plug-and-play machine.
- **Compact-sized**
The kernel of Rigid-750/Rigid-752 is FMB-i57M1, which is a non-standard form factor embedded board. The whole system consumes only a few space.
- **Fanless and Modular CPU Board**
By using a low power processor, the system does not have to rely on fans, which are often unreliable and cause dust to circulate inside the equipment. The modular design facilitates maintenance or possible upgrades on the CPU board. Modular Box PC can be easily modified to fit many different applications according to customers' requests.
- **Powerful Communication Capability**
The Rigid-750/Rigid-752 provides COM, LPT, Ethernet, USB, Mini Card slot, DVI and Digital I/O expansion slot.
- **Numerous Display/Video Output**
Integrated with Intel® HD Graphics core, Rigid-750/Rigid-752 improves graphics and 3D rendering performance and supports numerous display/video output options includes VGA and DisplayPort.
- **Advanced Storage Solution**
Rigid-750 / Rigid-752 comes with Compact Flash slot, which offers a better, faster and more cost-effective expansibilities for various applications.
- **Trustworthy**
The onboard Watchdog Timer can invoke an NMI or system RESET when your application loses control over the system.

1.2 Packing List

After opening the package, carefully inspect the contents. If any of the items is missing or appears damaged, please contact with your local dealer or distributor. The package should contain the following items:

General Information

Standard:



1 x Rigid-750 or Rigid-752 Box PC



1 x Accessory Box
(Driver CD/User's Manual/Screws/
Cable/Terminal Block)



AC/DC Adapter Kit



Wall-mount Kit



COM Converter Cable (1 x 44-pin male to 4 x DB9 male
+ 1 x DB9 female) L=200mm

Options:

The following items are normally optional, but some vendors may include them as a standard package, or some vendors may not carry all the items.



Intel® 2.5" 80GB SATAII SSD Kit



HSUPA 3.75G module kit

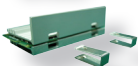

WT DDR3 2GB SDRAM DIMM2 kit

1.3 The Installation Paths of CD Driver

Windows XP

Driver	Path
CHIPSET	\\CHIPSET\\INTEL\\XP_32_64_WIN7_32_64_SERIES
VGA	\\GRAPHICS\\INTEL_2K_XP_32\\14425
LAN	\\ETHERNET\\INTEL\\XP_WIN7_SERIES\\32
AUDIO	\\AUDIO\\REALTEK_HD\\WINDOWS_R252
ME	\\ME\\6.1.0.1042_PV

Windows 7

Driver	Path
CHIPSET	\\CHIPSET\\INTEL\\XP_32_64_WIN7_32_64_SERIES
VGA	\\GRAPHICS\\INTEL_WIN7_VISTA_32\\Win7Vista_15179
LAN	\\ETHERNET\\INTEL\\XP_WIN7_SERIES\\32
AUDIO	\\AUDIO\\REALTEK_HD\\Vista_WINDOWS7_R251
ME	\\ME\\6.1.0.1042_PV

1.4 Specifications

System Kernel	
Processor	Intel® Core™ i5-520M
BIOS	AMI Flash BIOS
Chipset	Intel® QM57
Graphics	Intel® HD Graphics
System Memory	2 x 204-pin Dual-channels DDR3 SO-DIMM Sockets up to 8GB at 800/1066MHz (2GB WT DDR3-1333 SDRAM installed by default)
Serial ATA	2 x SATA 300MB/s
Expansion Bus	1 x Mini-card slot; 1 x SIM socket 1 x PCIe x8 slot w/ riser card (Rigid-750 only) 1 x PCIe x16 slot w/ riser card; 1 x PCIe x1 slot w/ riser card (Rigid-752 only)
Ethernet Controller	2 x Intel® WG82574IT Gigabit Ethernet controllers
Watchdog Timer	1 ~ 255 levels reset
I/O Ports	
Serial Port	<ul style="list-style-type: none"> • 4 x serial port via one DB-44 female connector • COM1~COM4: RS-232 • COM3, 4: RS-232/485

General Information

*Selectable Port	<ul style="list-style-type: none"> • 1 x LPT • 1 x 16-bit Digital I/O (8-in/8-out) • 1 x DVI-D (default)
USB Port	8 x USB 2.0 ports
LAN Port	2 x RJ-45
Video Port	1 x DB-15 for Analog RGB; 1 x DisplayPort; 1 x DVI
KB/MS	1 x 6-pin Mini-DIN for keyboard & mouse
Audio	Mic-in/Line-out (6W pre-amplified)
GSM/UMTS	Up to HSUPA 3.75G (optional Mini-card)
Storage	
HDD/SSD	1 or 2 x 2.5" drive bay for HDD or SSD w/ 9.5mm height
CF	1 x CFAST socket (outside accessible)
Safety	
FCC	Class A certified
CE	Certified
Environment	
Operating Temp.	-40 ~ 70°C (-40 ~ 158°F), ambience w/ air flow
Storage Temp.	-40 ~ 85°C (-40 ~ 185°F)
Relative Humidity	10 ~ 95% @ 40°C (non-condensing)
Vibration	3 Grms/5 ~ 500 Hz/random operation
Shock & Crash	Operating 20G, 11ms; Non-operating 40G with HDD, 11ms Operating 40G, 11ms; Non-operating 60G with CFAST/SSD, 11ms Crash 80G, 11ms
Mechanical	
Construction	Aluminum alloy
Mounting	Wall mounting
Weight	Rigid-750: 4.5 kg (9.9 lb); Rigid-752: 4.8 kg (10.56 lb)
Dimensions (W x D x H)	Rigid-750: 195 x 268 x 90 mm (7.68" x 10.55" x 3.54") Rigid-752: 195 x 268 x 110 mm (7.68" x 10.55" x 4.33")

*** The selectable ports, including DVI-D, LPT and Digital I/O, are options that only one of which can be equipped.**

1.5 Power Information

Power Connector	1 x 4-pin DC input receptacle combined with a power on/off switch for remote control
Input Voltage	DC 10 ~ 28V
Power Consumption	120W (Max.)

1.6 Dimensions

Rigid-750

- Dimension (W x D x H): 195 x 268 x 90 mm (7.68" x 10.55" x 3.54")

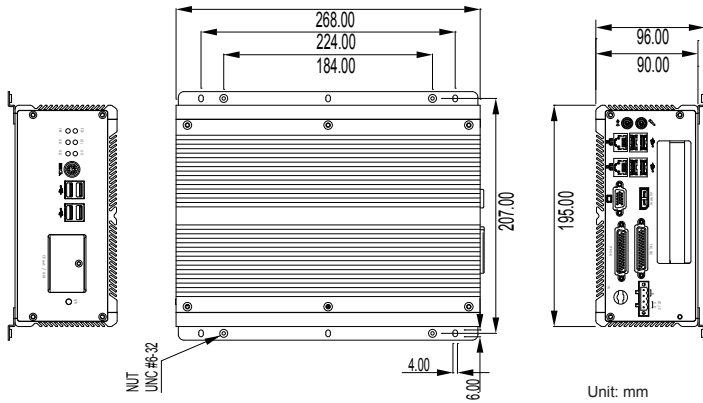

Rigid-752

- Dimension (W x D x H): 195 x 268 x 110 mm (7.68" x 10.55" x 4.33")

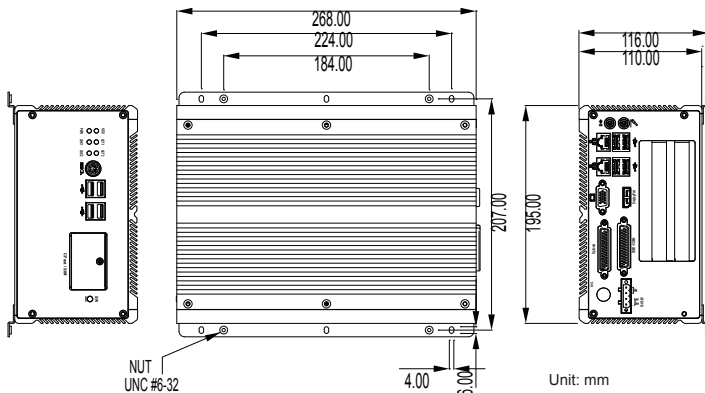

1.7 Locating Controls and Connectors

Both Rigid-750 and Rigid-752 have the same I/O ports and connectors at the front panel.

Please take a moment to identify those controls and connectors shown in the following figures.

Front Panel

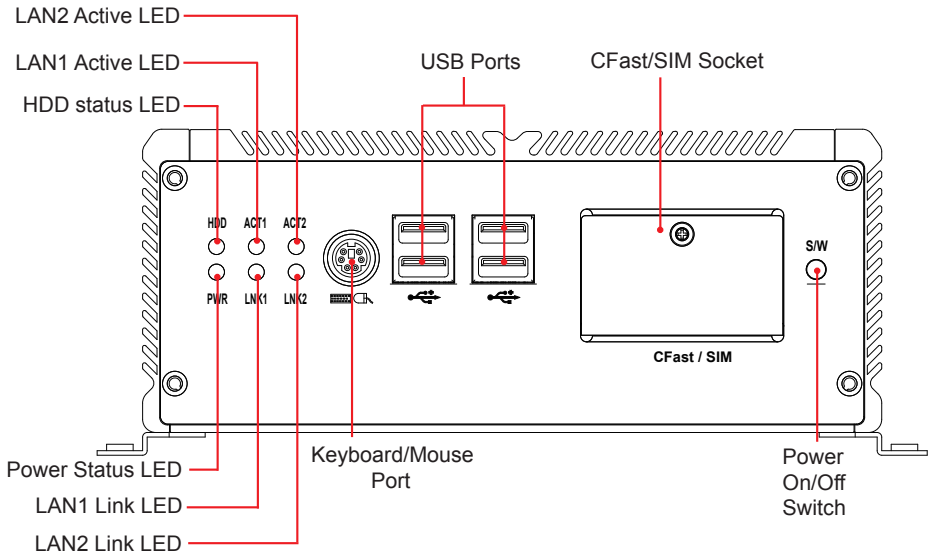

Rear Panel Rigid-750

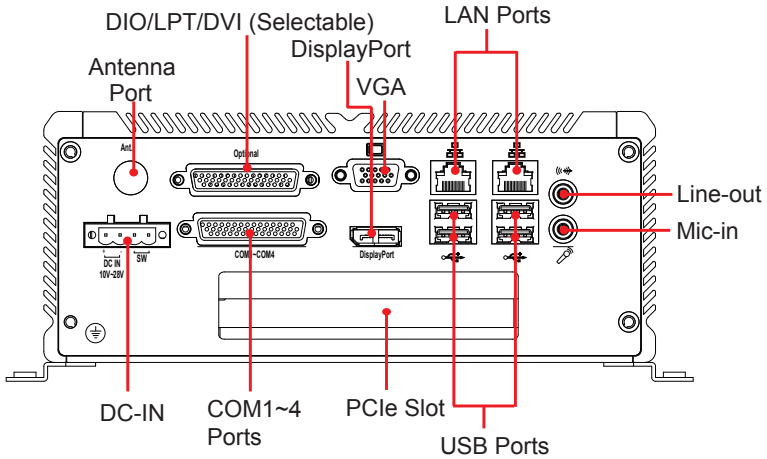

Rigid-752

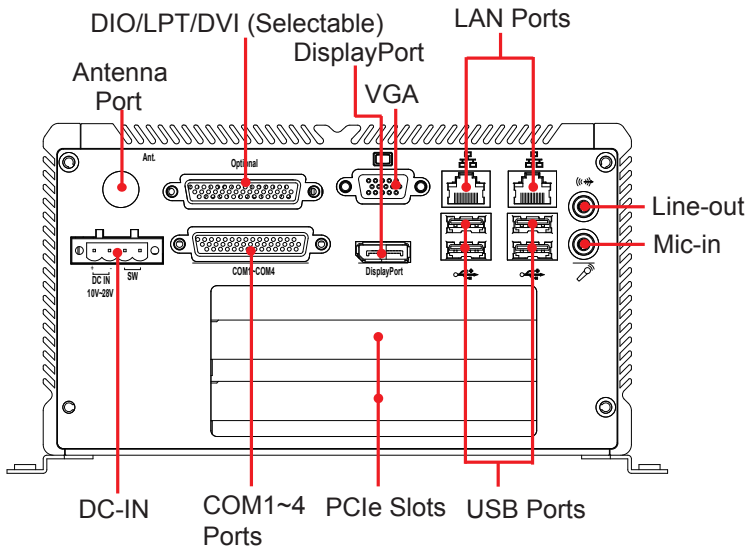

1.8 Connecting Peripherals

The user can use the I/O interfaces located at the rear side of the chassis to connect to external peripheral devices, such as a mouse, a keyboard, a monitor, serial devices or parallel printer, etc. Before connection, make sure that the computer and the peripheral devices are turned off.

1.8.1 VGA/DVI/DisplayPort Video Outputs

Both Rigid-750 and Rigid-752 are equipped with two video outputs—one 15-pin VGA, one DisplayPort—and one DVI at the rear side of the chassis for multiple display connections.

The new DisplayPort video interface features small USB sized connector, long cable support especially for digital projectors or remote displays, WQXGA High Definition (2560 x 1600), interoperability with DVI and HDMI over DisplayPort connector, etc.

Rigid-750

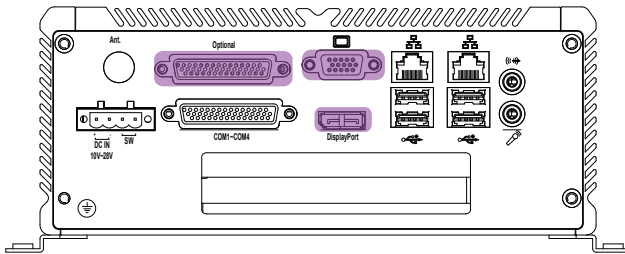

Rigid-752

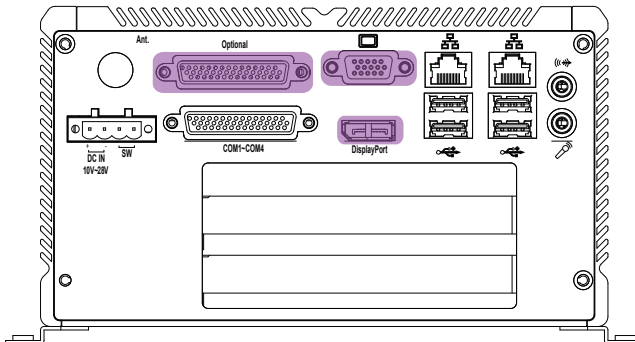

1.8.2 Serial Ports (COM1 ~4)

Both Rigid-750 and Rigid-752 are built with an integrated serial ports that combines COM1 ~ COM4 into a D-sub 44-pin female connector. Each port supports RS-232; in addition, COM3, 4 supports RS-232/485 selectable.

To connect to any serial device, follow the steps below:

1. Turn off the BOX PC system and the serial devices.
2. Attach the interface cable of the serial device to the serial connector. Be sure to fasten the retaining screws.
3. Turn on the computer and the attached serial devices.
4. Refer to the serial device's manual for instructions to configure the operation environment to recognize the new attached devices.
5. If the serial device needs specified IRQ or address, you may need to run the CMOS setup to change the hardware device setup.

Rigid-750

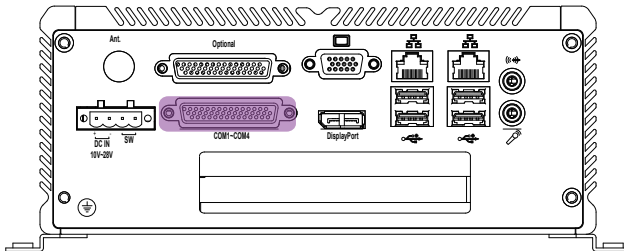

Rigid-752

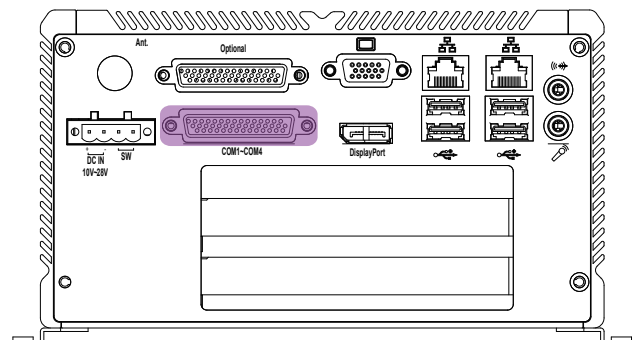

1.8.3 LAN Ports

Both Rigid-750 & Rigid-752 provide two Intel® WG82574IT 10/100/1000 Base-T Ethernet (RJ-45) interface. For network connection, follow the instructions below:

1. Turn off the BOX PC system and the Ethernet hubs.
2. Plug in one end of cable of a 10/100/1000Base-T hub to the system's RJ-45 jack.

Rigid-750

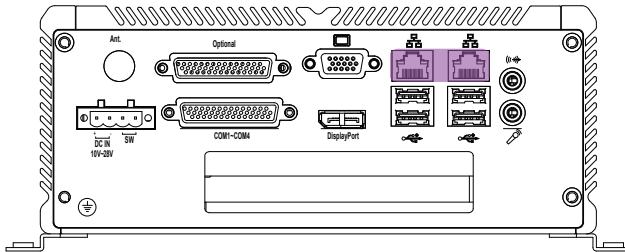

Rigid-752

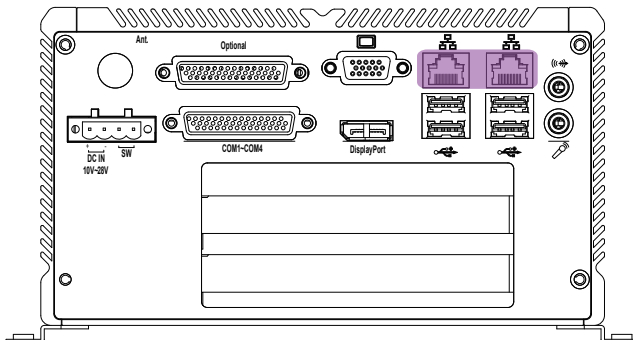

1.8.4 USB Ports

Both Rigid-750 & Rigid-752 have four USB ports on the front panel and four USB ports on the rear panel to connect to external USB devices. USB ports and devices are hot-pluggable. Therefore, any USB device can be connected at all time without turning off your system.

Front Panel

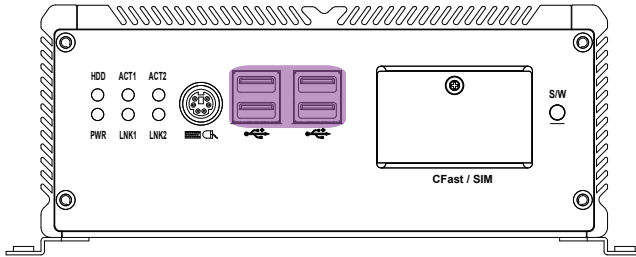

Rear Panel

Rigid-750

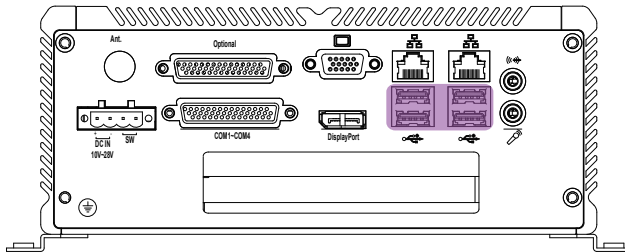

Rigid-752

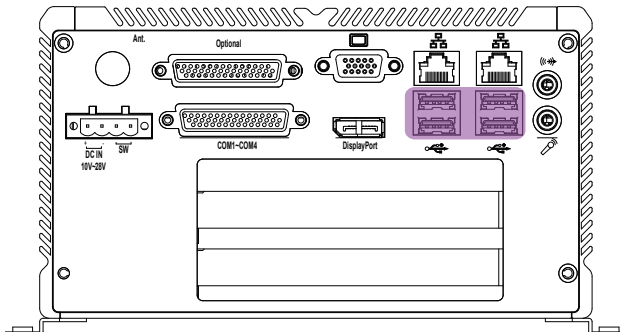

Note that for many of these devices, you will first have to install proper device drivers before they can be recognized by the system.

1.8.5 Keyboard and Mouse

Both Rigid-750 & Rigid-752 have one PS/2 keyboard/mouse connector located at the front panel.

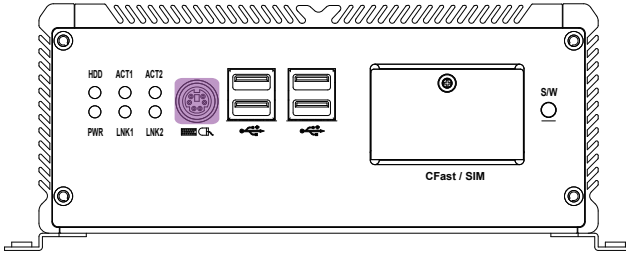

To connect an AT keyboard, an adapter between the PS/2 interface and the AT Keyboard is needed.

1.8.6 Expansion PCIe Slots

Rigid-750 has one PCIe slot located at the rear panel while Rigid-752 provides two.

Rigid-750

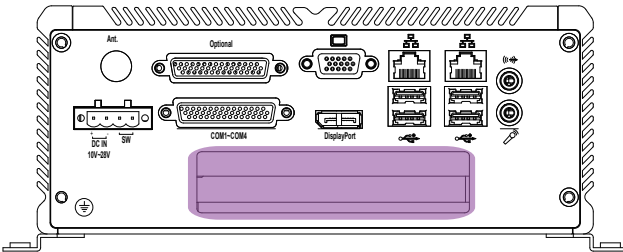

Rigid-752

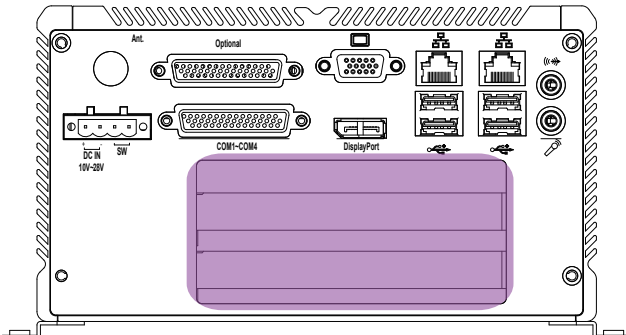

1.8.7 Audio Line-out/Mic-in

Two audio jacks for Line-out and Mic-in located at the rear panel.

Rigid-750

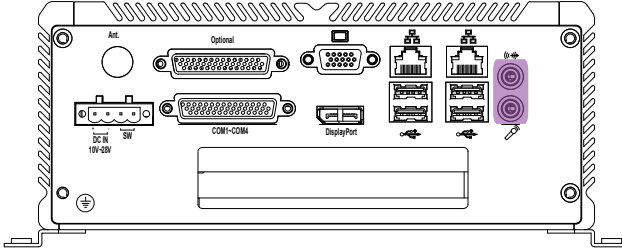

Rigid-752

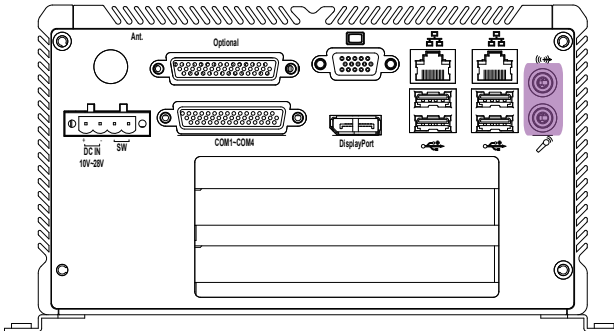

1.8.8 DC Power Input and Power ON/OFF Button

For DC power input, the computer is equipped with a 4-pin terminal block receptacle on the rear panel. The “S/W” button located on the front panel is used to power ON/OFF the computer. See the figures below.

Front Panel

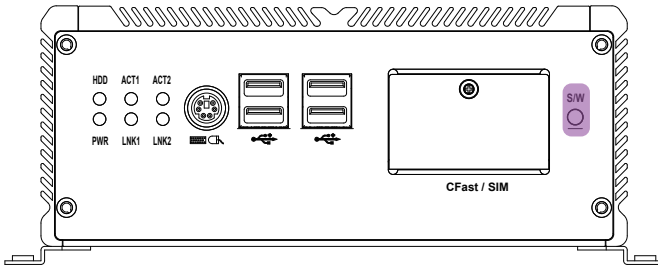

Rear Panel

Rigid-750

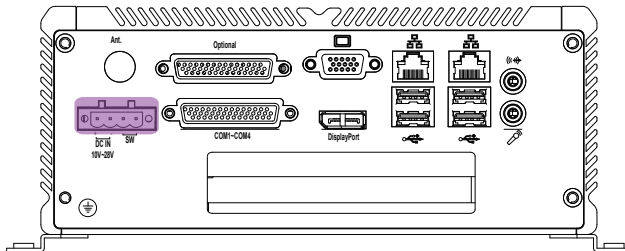

Rigid-752

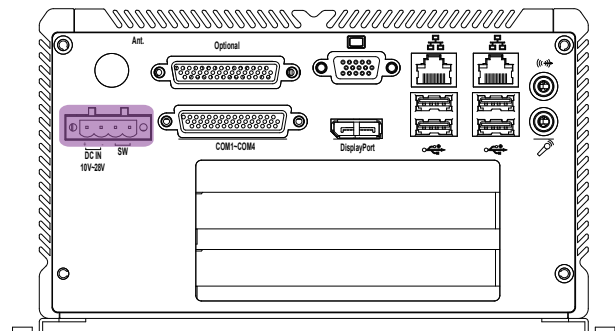

This page is intentionally left blank.

Chapter 2

The Engine of Rigid-750/Rigid-752

2.1 Board Layout

The engine of Rigid-750 / Rigid-752 is constructed by the combination of one PCBA board. Such a combination makes system customization feasible.

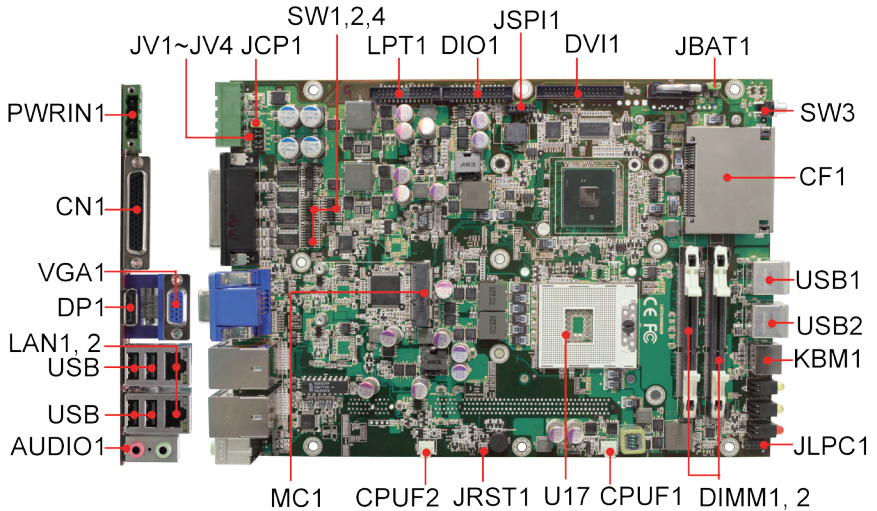

Main Board Top View

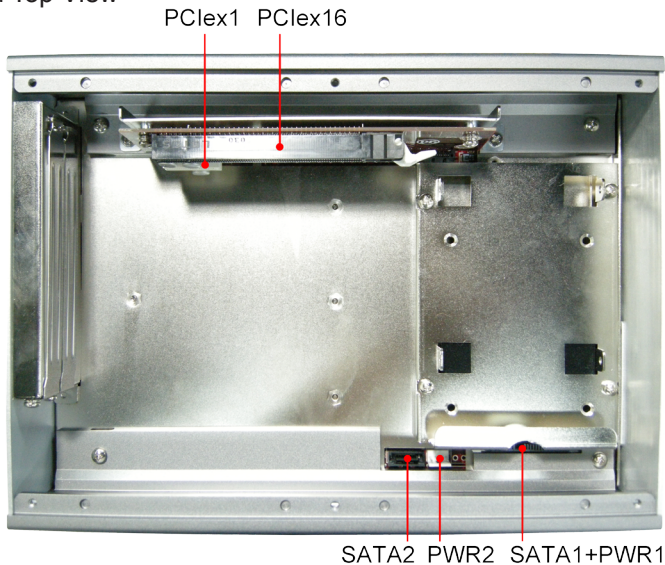

Rigid-750/Rigid-752 Bottom View

2.2 Jumpers and Connectors

2.2.1 Jumpers & Connectors List







Jumpers

Label	Function
JBAT1	Clear CMOS Setup
JCP1	COM Ports Power Selection
JV1 ~ JV4	RI/5V/12V (Pin 9) Selection for Each of the 4 COM Ports

Connectors

Label	Function	Label	Function
PWRIN1	Power Input	DVI1	DVI Display Box Header
CN1	COM1, 2: RS-232 COM3, 4: RS-232/RS-485	JSPI1	System BIOS Enable/ Disable Pin Header
VGA1	CRT Display Connector	DIO1	16-bit Digital I/O Connector
DP1	DisplayPort Connector	LPT1	Parallel Port
LAN1, 2	Ethernet Connector (includes USB Connectors)	SW1, 2, 4	RS-232/RS-485 Select Jumper (for COM3, 4)
AUDIO1	Audio Jacks Connector	PCIe1	PCIe x16 Interface Slot
MC1	Mini Card Slot	PCIe2	PCIe x1 Interface Slot
CPUF1	CPU Fan Connector	SATA1	Serial ATA + Power Connectors
CPUF2	System Fan Connector	SATA2	Serial ATA Connectors
JRST1	Reset Pin Header	PWR1, 2	HDD/SSD Power Connectors
U17	CPU Socket	SIM1	SIM Card Socket
DIMM1, 2	204-pin dual-channel DDR3 SO-DIMM Slot		
JLPC1	For Debug (Factory Use Only)		
KBM1	PS/2 Keyboard and Mouse Connector		
USB1, 2	USB Connectors		
CF1	CFast Socket		
SW3	Power ON/OFF Button		

2.2.2 Jumper Setting

Label	Function	Jumper Settings
JBAT1	Clear CMOS	1-2: Keep CMOS (default) 
		2-3: Clear CMOS 
JCP1	COM Ports Power Selection	1-2: +5V (default) 
		2-3: +12V 
JV1~JV4	RI/5V/12V (Pin 9) Selection for Each of the 4 COM Ports	1-2: RI (default) 
		2-3: 5V or 12V (depends on JCP1) 

SW1, 2, 4 (RS-232/RS-485 Function Select Jumper for COM3, COM4)

SW1 Setting

COM3	RS-232	RS-485
1-16	ON	OFF
2-15	OFF	ON
3-14	OFF	ON
4-13	OFF	ON

COM4	RS-232	RS-485
5-12	ON	OFF
6-11	OFF	ON
7-10	OFF	ON
8-9	OFF	ON

SW2 Setting

COM4	RS-232	RS-485
1-16	ON	OFF
2-15	ON	OFF
3-14	ON	OFF
4-13	ON	OFF
5-12	ON	OFF
6-11	ON	OFF
7-10	ON	OFF
8-9	ON	OFF

SW4 Setting

COM3	RS-232	RS-485
1-16	ON	OFF
2-15	ON	OFF
3-14	ON	OFF
4-13	ON	OFF
5-12	ON	OFF
6-11	ON	OFF
7-10	ON	OFF
8-9	ON	OFF

2.2.3 Pin Assignments for Connectors

PWRIN1 (Power Input)

Power Input Terminal Block Receptacle

Connector type: 4-pin terminal block

Pin	Description
1	DC input 10~28V
2	GND
3	GND-
4	Remote Power Button

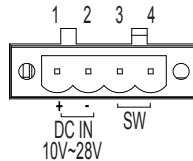

CN1 (COM1 ~ COM4)

DB-44 female connector:
serial port 1 ~ 4

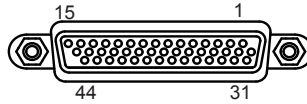

	Pin	Desc.	Pin	Desc.		Pin	Desc.	Pin	Desc.
COM1 (RS-232)	1	DCD	2	RXD	COM2 (RS-232)	11	DCD	12	RXD
	3	TXD	4	DTR		13	TXD	14	DTR
	5	GND	6	DSR		15	GND	16	DSR
	7	RTS	8	CST		17	RTS	18	CST
	9	RI	10	GND		19	RI	20	GND
COM3 (RS-232)	21	DCD	22	RXD	COM4 (RS-232)	31	DCD	32	RXD
	23	TXD	24	DTR		33	TXD	34	DTR
	25	GND	26	DSR		35	GND	36	DSR
	27	RTS	28	CST		37	RTS	38	CST
	29	RI	30	GND		39	RI	40	GND
N/C	41	N/C	42	N/C					
	43	N/C	44	N/C					

CBL-7100-COM (COM Converter Cable) (Optional)

1 to 5 COM converter cable: 4 x DB9 male and 1 x DB9 female connectors

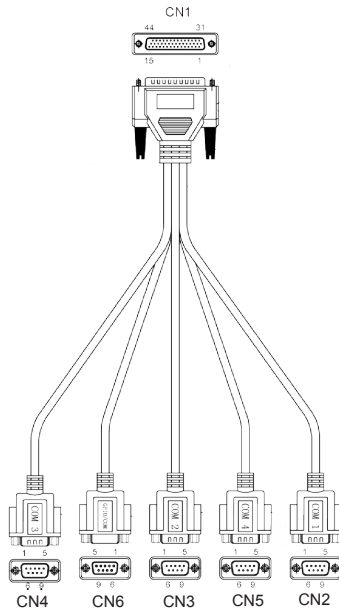

COM1 (RS-232) labelled CN2 on DB9 Cable Controller					
DB44 Pin	DB9 Pin	Desc.	DB44 Pin	DB9 Pin	Desc.
1	1	DCD	2	2	RXD
3	3	TXD	4	4	DTR
5	5	GND	6	6	DSR
7	7	RTS	8	8	CTS
9	9	RI	10		GND

COM2 (RS-232) labelled CN3 on DB9 Cable Controller					
DB44 Pin	DB9 Pin	Desc.	DB44 Pin	DB9 Pin	Desc.
11	1	DCD	12	2	RXD
13	3	TXD	14	4	DTR
15	5	GND	16	6	DSR
17	7	RTS	18	8	CTS
19	9	RI	20		GND

232 mode

COM3 (RS-232) labelled CN4 on DB9 Cable Controller					
DB44 Pin	DB9 Pin	Desc.	DB44 Pin	DB9 Pin	Desc.
21	1	DCD	22	2	RXD
23	3	TXD	24	4	DTR
25	5	GND	26	6	DSR
27	7	RTS	28	8	CTS
29	9	RI	30		GND

485 mode

COM3 (RS-485) PIN OUT					
Pin	Signal	Desc.	Pin	Signal	Desc.
1	DATA-	TX/RXDATA-	6	N/C	
2	DATA+	TX/RXDATA+	7	N/C	
3	N/C		8	N/C	
4	N/C		9	N/C	
5	GND	Ground			

232 mode

COM4 (RS-232) labelled CN5 on DB9 Cable Controller					
DB44 Pin	DB9 Pin	Desc.	DB44 Pin	DB9 Pin	Desc.
31	1	DCD	32	2	RXD
33	3	TXD	34	4	DTR
35	5	GND	36	6	DSR
37	7	RTS	38	8	CTS
39	9	RI	40		GND

485 mode

COM4 (RS-485) PIN OUT					
Pin	Signal	Desc.	Pin	Signal	Desc.
1	DATA-	TX/RXDATA-	6	N/C	
2	DATA+	TX/RXDATA+	7	N/C	
3	N/C		8	N/C	
4	N/C		9	N/C	
5	GND	Ground			

Note: CN6 on DB9 Cable Controller is unused.

VGA1 (CRT Display Connector)

Three-row/15-pin VGA Connector

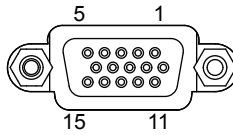

Pin	Description	Pin	Description	Pin	Description
1	RED	6	GND	11	N/C
2	GREEN	7	GND	12	VDDAT
3	BLUE	8	GND	13	HSYNC
4	N/C	9	VCC	14	VSYNC
5	GND	10	GND	15	VDCLK

DP1 (DisplayPort Connector)

Digital Audio/Video Connector

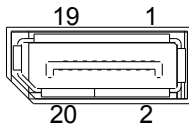

Pin	Description	Pin	Description
1	LANE_0P	11	GND
2	GND	12	LANE_3N
3	LANE_0N	13	GND
4	LANE_1P	14	GND
5	GND	15	GND
6	LANE_1N	16	COM3_CTS#
7	LANE_2P	17	AUX_N
8	GND	18	HPD
9	LANE_2N	19	RTN_PWR
10	LANE_3P	20	PWR

LAN1/2 (LAN Ports)

RJ-45 Connector

Pin	Description	Pin	Description
1	MDI0+	5	MDI2+
2	MDI0-	6	MDI2-
3	MDI1+	7	MDI3+
4	MDI10-	8	MDI3-

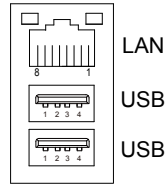

USB1/2 (USB Ports)

USB 2.0 type A connector

Pin	Description
1	5V
2	USB-
3	USB+
4	GND

AUDIO1 (Audio Jacks)

Jack	Description
Green	Line-out
Pink	Microphone



MC1 (PCIe Mini-card socket)
 PCI Express MiniCard socket

Pin	Desc.	Pin	Desc.	Pin	Desc.
1	Wake	20	W_Disable#	36	USB_D-
2	+3.3V	21	GND	37	Reserved8
3	Reserved10	22	PERST#	38	USB_D+
4	GND	23	PERn0	39	Reserved7
5	Reserved9	24	+3.3V	40	GND
6	+1.5V	25	PERp0	41	Reserved6
7	CLKREQ#	26	GND	42	LED_WWAN#
8	UIM_PWR	27	GND	43	Reserved5
9	GND	28	+1.5V	44	LED_WLAN#
10	UIM_DATA	29	GND	45	Reserved
11	REFCLK-	30	SMB_CLK	46	LED_WPAN#
12	UIM_CLK	31	PETn0	47	Reserved
13	REFCLK+	32	SMB_DATA	48	+1.5V
14	UIM_RESET	33	PETp0	49	Reserved
15	GND	34	GND	50	GND
16	UIM_VPP	35	GND	51	Reserved
17	UIM_C8/Reserved			52	+3.3V
18	GND				
19	UIM_C4/Reserved				

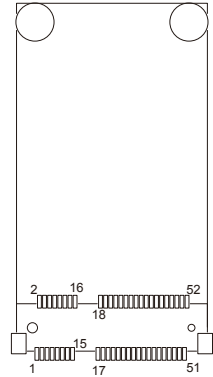

Board Top

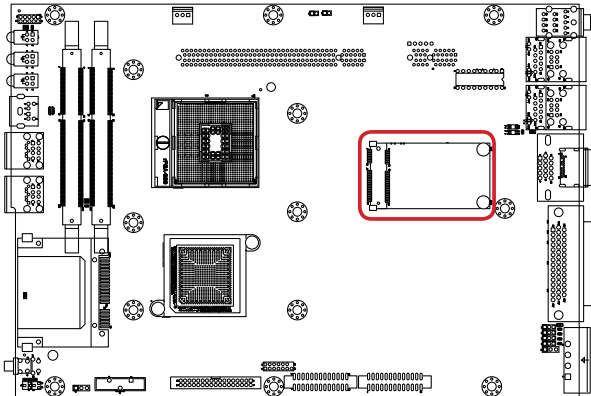

CPUF1/2 (Fan Connector)

Pin	Description
1	GND
2	+12V
3	FAN_CTL



KBM1 (Keyboard & Mouse)

PS/2 keyboard & Mouse

Connector type: 6-pin Mini-DIN connector

Pin	Description
1	KB_DAT
2	MS_DAT
3	GND
4	VCC5
5	KBCLK
6	MSCLK

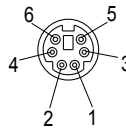

CF1 (CFast Slot)

CFast Card Type I/II slot

Connector type: 7+17-pin CFast Card connector consisting of a SATA compatible 7-pin signal connector and a 17-pin power and control connector.

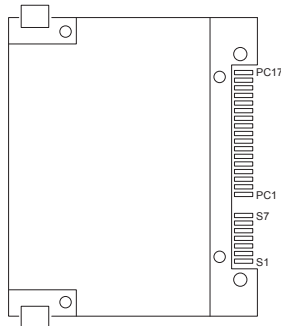

Pin	Segment	Name	Type	Description
S1	SATA	SGND	Signal GND	Ground for signal integrity
S2	SATA	A+	SATA Differential	Signal Pair A
S3	SATA	A-	SATA Differential	
S4	SATA	SGND	Signal GND	Ground for signal integrity
S5	SATA	B-	SATA Differential	Signal Pair A
S6	SATA	B+	SATA Differential	
S7	SATA	SGND	Signal GND	Ground for signal integrity
	Key			
	Key			
PC1	PWR/CTL	CDI	CMOS Input	Card Detect In
PC2	PWR/CTL	GND	Device GND	
PC3	PWR/CTL	TBD	TBD	
PC4	PWR/CTL	TBD	TBD	
PC5	PWR/CTL	TBD	TBD	
PC6	PWR/CTL	TBD	TBD	
PC7	PWR/CTL	GND	Device GND	
PC8	PWR/CTL	LED1	LED Output	LED Output
PC9	PWR/CTL	LED2	LED Output	LED Output
PC10	PWR/CTL	IO1	CMOS Input/Output	Reserved Input/Output
PC11	PWR/CTL	IO2	CMOS Input/Output	Reserved Input/Output
PC12	PWR/CTL	IO3	CMOS Input/Output	Reserved Input/Output
PC13	PWR/CTL	PWR	3.3V	Device Power (3.3V)
PC14	PWR/CTL	PWR	3.3V	Device Power (3.3V)
PC15	PWR/CTL	PGND	Device GND	Device Ground
PC16	PWR/CTL	PGND	Device GND	Device Ground
PC17	PWR/CTL	CDO	CMOS Output	Card Detect Out

DVI1 (DVI)

Onboard Digital Visual Interface Connector

Connector type: 2.00mm pitch 2x17-pin box header

Pin	Description	Pin	Description
1	Analog GND	2	Analog GND
3	T.M.D.S. Data2-	4	T.M.D.S. Data2+
5	GND	6	N/C
7	N/C	8	DDC Clock
9	DDC Data	10	N/C
11	T.M.D.S. Data1-	12	T.M.D.S. Data1+
13	Analog GND	14	N/C
15	N/C	16	+5V
17	Analog GND	18	Hot Plug Detect
19	T.M.D.S. Data0-	20	T.M.D.S. Data0+
21	Analog GND	22	N/C
23	N/C	24	GND
25	T.M.D.S. CLK+	26	T.M.D.S. CLK-
27	GND	28	GND
29	N/C	30	N/C
31	N/C	32	Analog GND
33	Analog GND	34	N/C



JSPI1 (System BIOS Enable/ Disable Pin Header, factory use only)

Pin	Enable BIOS	Disable BIOS
1-2	ON	OFF
3-4	ON	OFF
5-6	ON	OFF
7-8	ON	OFF
9-10	ON	OFF
11-12	N/C	SPI_CS1
13-14	GND	N/C (Key)

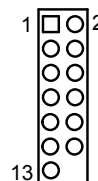

DIO1 (Digital I/O Port)

On-board Digital I/O Connector
 Connector type: 2.00mm pitch
 2x13-pin box header



Pin	Description	Pin	Description
1	DIO0	14	DIO1
2	DIO2	15	DIO3
3	DIO4	16	DIO5
4	DIO6	17	DIO7
5	DIO8	18	DIO9
6	DIO10	19	DIO11
7	DIO12	20	DIO13
8	DIO14	21	DIO15
9	VCC5	22	GND
10	VCC5	23	GND
11	N/C	24	N/C
12	N/C	25	N/C
13	N/C	26	N/C

LPT1 (Parallel Port)

On-board Parallel Port Connector
 Connector type: 2.00mm pitch
 2 x13-pin box header



Pin	Description	Pin	Description
1	XP_STB#	14	P_AFD#
2	XP_D0	15	P_ERR#
3	XP_D1	16	P_INIT#
4	XP_D2	17	P_SLIN#
5	XP_D3	18	GND
6	XP_D4	19	GND
7	XP_D5	20	GND
8	XP_D6	21	GND
9	XP_D7	22	GND
10	P_ACK#	23	GND
11	P_BUSY	24	GND
12	P_PE	25	GND
13	P_SLCT	26	GND

SATA1/2 (Serial ATA Connectors)

On-board Serial ATA Connector

Pin	Description
1	GND
2	TX+
3	TX-
4	GND
5	RX-
6	RX+
7	GND

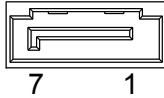
**PWR1/2 (HDD/SSD Power Connectors)**

Onboard HDD/SSD Power Connector

Pin	Description
1	VCC5
2	GND
3	GND
4	+12V





Chapter 3

Installation and Maintenance

3.1 CPU and Memory Module Installation

Rigid-750 / Rigid-752 is designed to be modular, slim and lightweight for easier maintenance. The following sections describe simple hardware installations.

3.1.1 Removing Top Cover

1. Locate the six screws which secure the top cover.

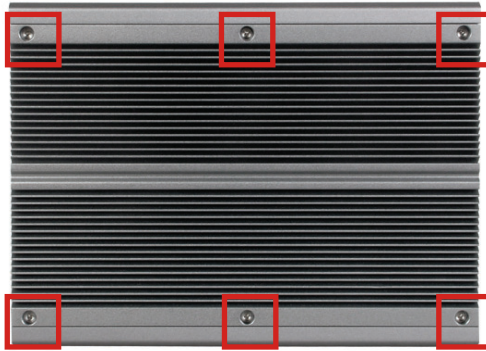

2. Use a screwdriver to remove the top cover screws. First unscrew the four screws in each corner, and then the two screws in the middle of the two sides. Keep the screws safely for later use. **(Note: Remember to first secure the two screws in the middle and then the two sides when you are to install the top cover.)**
3. Slightly pull the top cover upward.

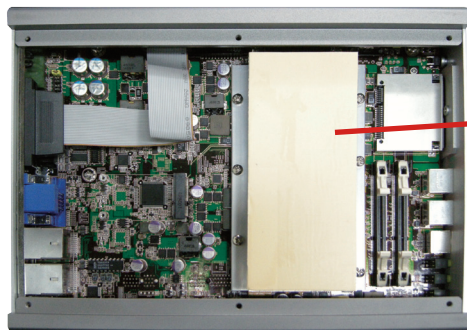

Thermal Lump
of PCH & CPU

3.1.2 Installing CPU

1. Locate the six screws which secure the Thermal Lump.
2. Use a screwdriver to remove the six screws and keep them safely for later use.

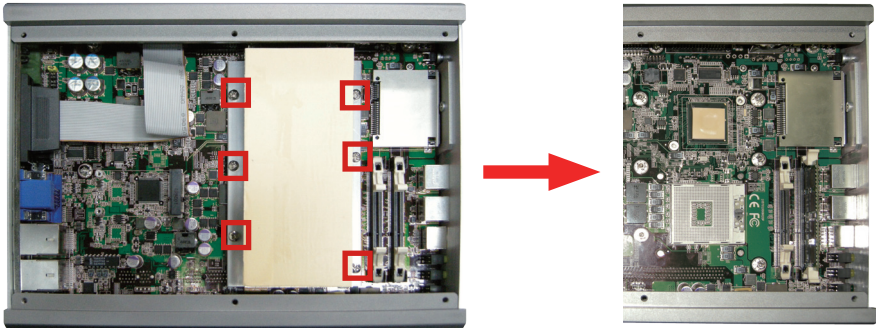

3. The processor socket comes with a screw to secure the CPU. As shown in the picture below, loose the screw first before inserting the CPU.

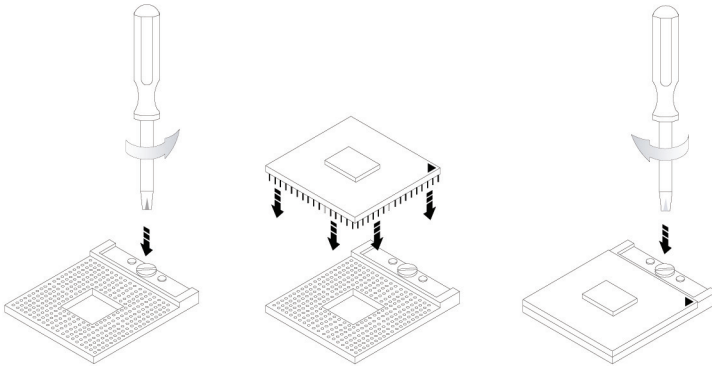

4. Place the CPU into the socket by making sure the notch on the corner of the CPU corresponding with the notch on the inside of the socket. Once the CPU is slid into the socket, lock the screw.
5. The contact area and gap between the processor and the heatsink require a thermal pad or thermal paste. Make sure that heatsink of the CPU top surface is in complete contact to avoid the CPU overheating problem. If not, it would cause your system or CPU to be hanged, unstable, or damaged.

3.1.3 Installing Memory Module

1. Locate the 200-pin SO-DIMM slots in and press down the clips.
2. Align the SO-DIMM on the slot and let the notch on the SO-DIMM meet the break on the slot.
3. Hold the SO-DIMM with both hands, and gently insert the SO-DIMM into the slot until the clips of the SO-DIMM slot close to lock the memory module in place.

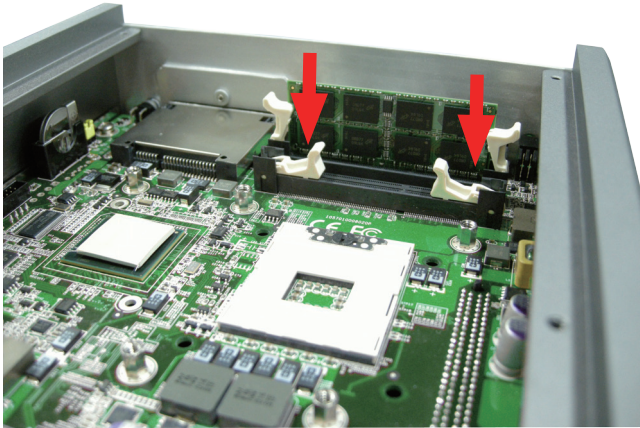

4. To remove the memory module, just press down the clips of the SO-DIMM slot with both your hands. And then the memory module will be lifted up for removing.

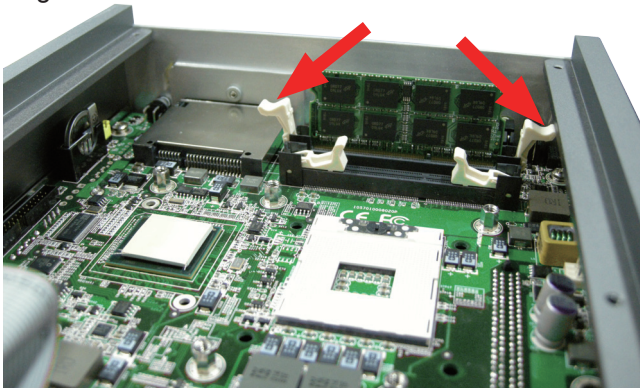

3.1.4 Installing Memory Module with Thermal Pad

1. Prepare the metal bracket set.

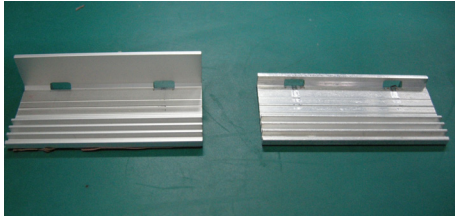

2. Attach the SO-DIMM to the thermal pad on the bracket with bigger top edge.

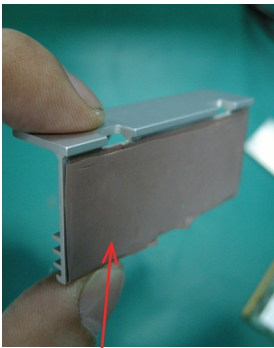

Thermal pad

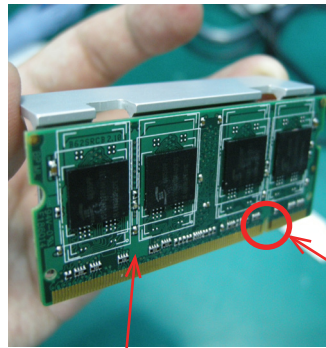

The opening of the 200-pin SO-DIMM

SO-DIMM attached to the pad

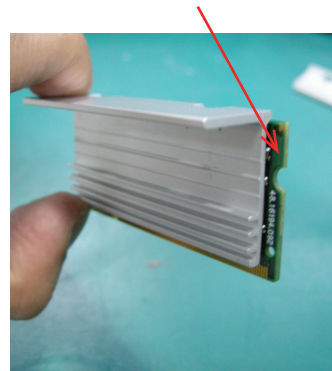

(View from another angle --->)

3. Attach another bracket of thermal pad to the SO-DIMM and hold them tight.

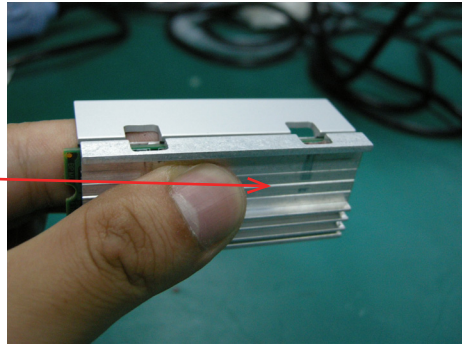
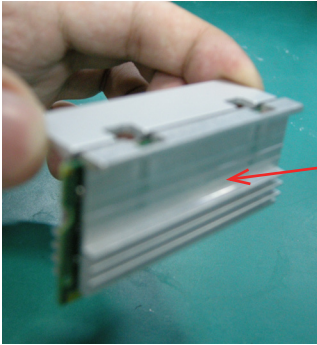

Note:

Make sure the two pads are aligned properly so that the two opening holes can be formed.

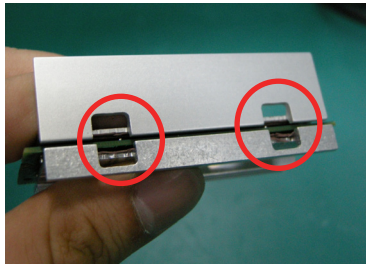

4. Take out the two metal clips.

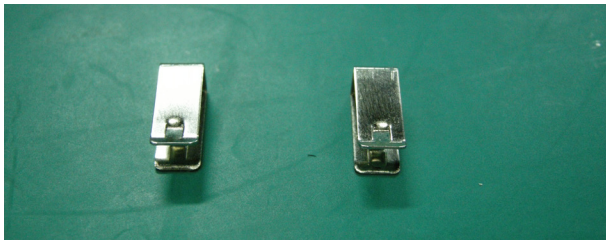

5. Use the clips to secure the metal brackets.

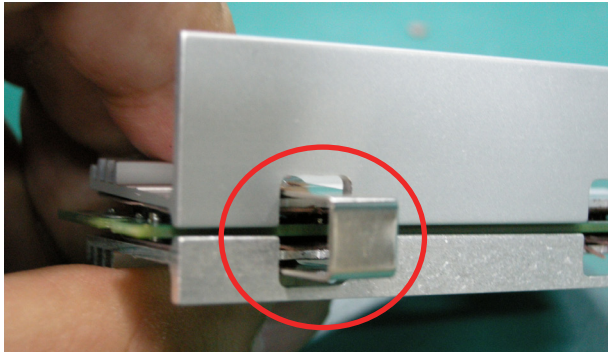
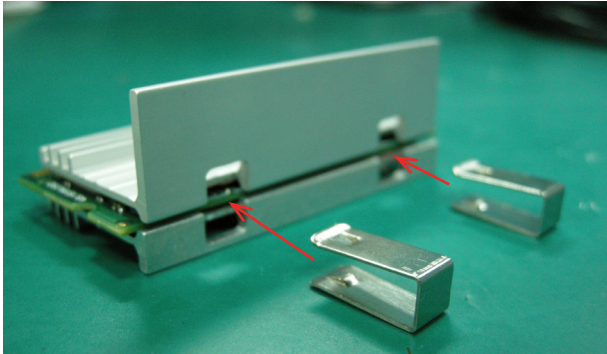

Note:
Make sure you clip the brackets on both sides as the figures below.

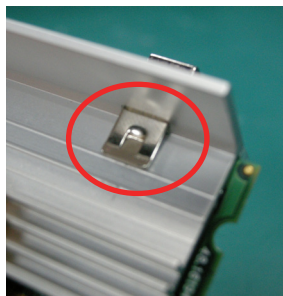
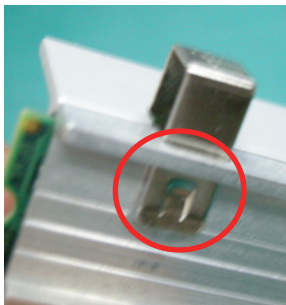

6. Push the clips all the way in until it totally fits in.

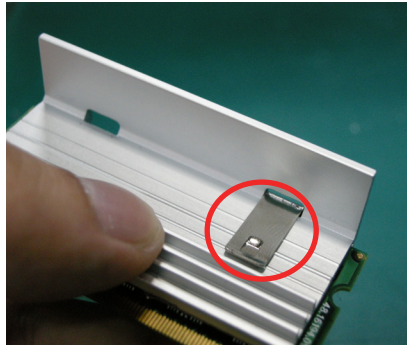
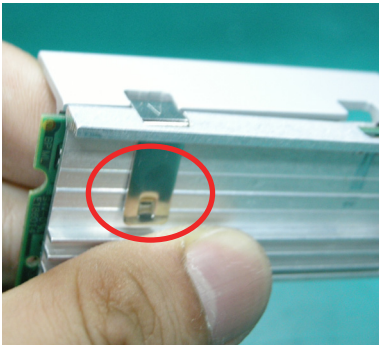
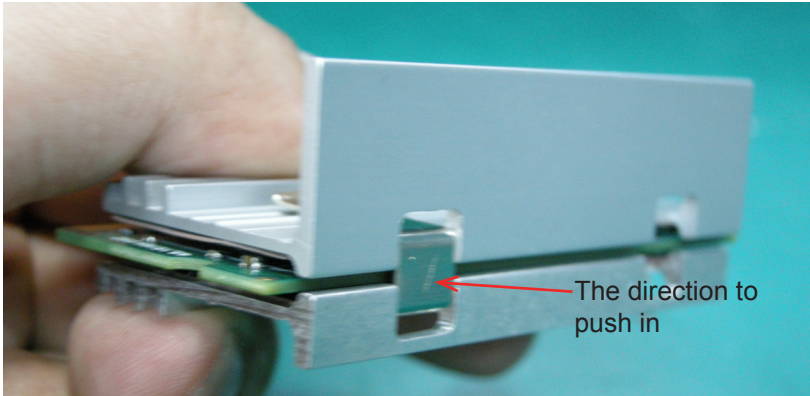

Note:

The figures above only demonstrate how to secure with one clip. When you install SO-DIMM with the thermal pads, make sure you do the same for both clips.

7. Locate the SO-DIMM slot on the board. Please refer to the previous section for its location.
8. Gently and accurately insert the SO-DIMM into the slot.

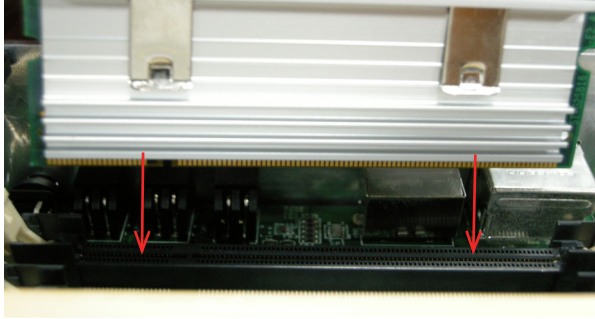

9. When the SO-DIMM fits into the slot, the clips from both side will automatically lock the SO-DIMM.



10. Attach the thermal pad on the top edge.

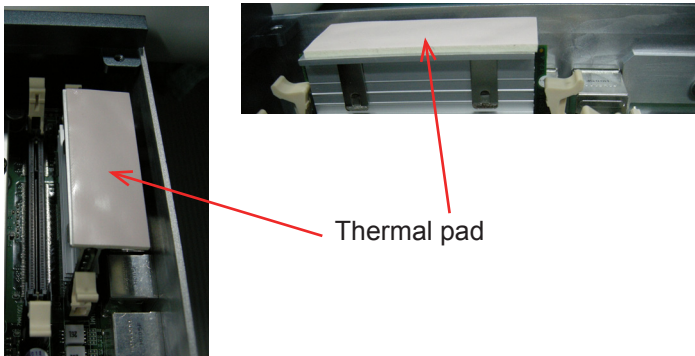

3.1.5 Installing HSUPA 3.75G Module

1. Locate Mini Card Slot (refer to Section 2.1 **Board Layout** for its position), insert the HSUPA module into it at a slanted angle as shown in the picture. Remember to align the notch on module with the break on slot. And then, secure two screws to fasten the module.

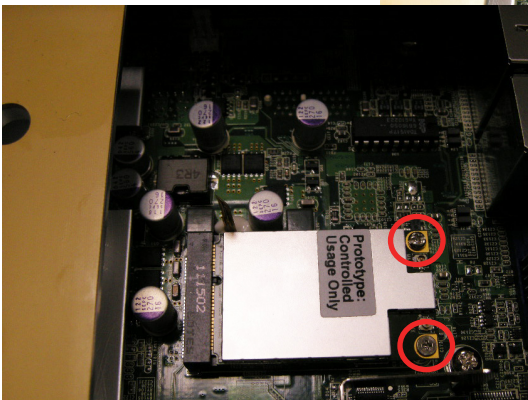
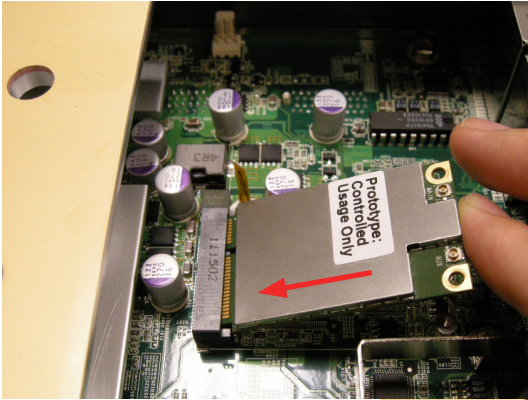

2. Press one end of the RF cable into one of the studs named MAIN as shown in the following picture.

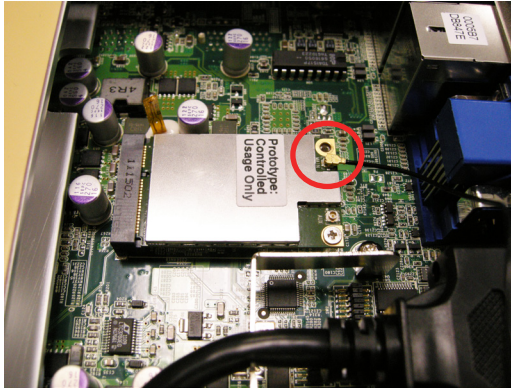

3. Push the plastic plug outwards to remove it, so that another end of RF cable, which is a SMA connector jack, can penetrate through antenna hole located on front panel of the chassis. Keep the plastic plug for later use. When you try to penetrate the SMA connector jack through antenna hole, be sure to put the flat side (in red frame) downwards, or it'll get stuck.

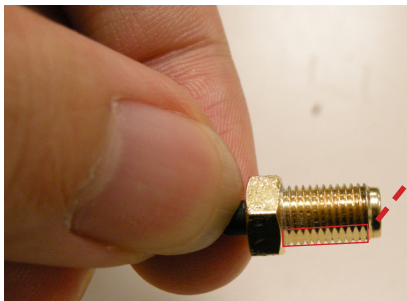
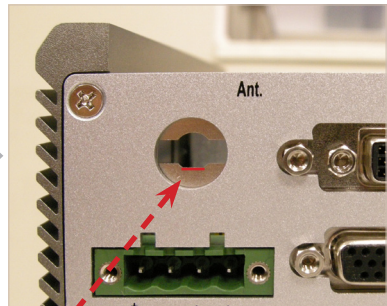
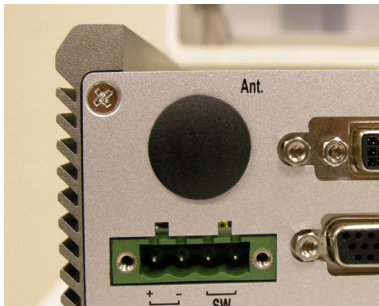

Align the flat fitting side with the red flat edge of antenna hole.

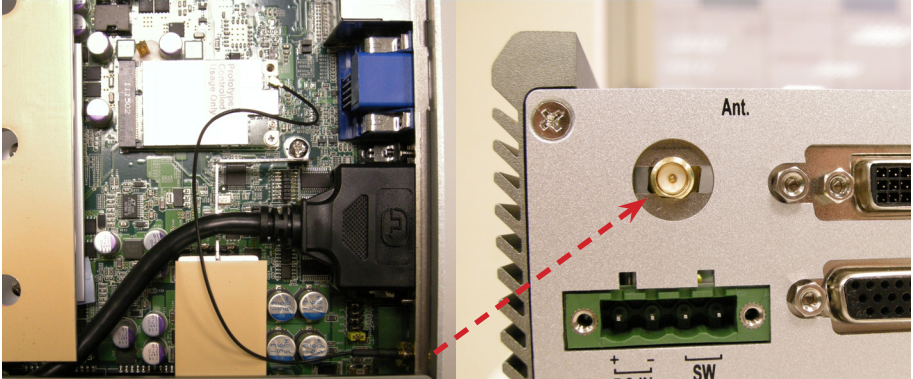

4. Mount a round washer into the SMA connector jack from outside before securing another nut into it.

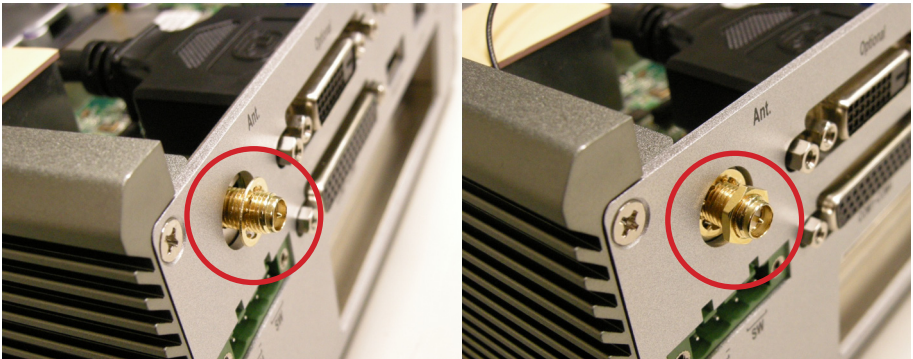

5. At the end, screw antenna into the SMA connector jack and adjust antenna angle for better signal.

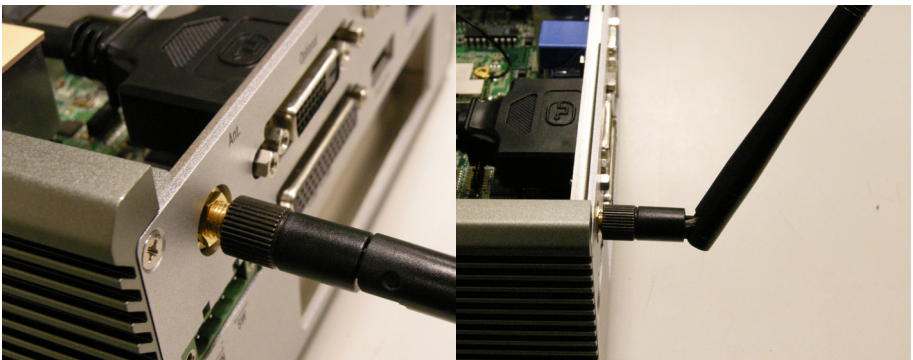

3.2 How to Access CFast/SIM Card

1. Make sure you have turned off the power before inserting or ejecting the CFast card (if OS is installed on CFast card).
2. Locate the CFast card door on the front panel.
3. Use a crosshead screwdriver (#1 tip) to remove the screw that secures the CFast/SIM card door. Pull down the door.



4. Insert your CFast/SIM card into the slot according to the illustration that you find close to the card holder.



Insert CFast card



Insert SIM card

5. After inserting the CFast/SIM card, close the card door and screw it on clockwise.



6. To remove the CFast card or SIM card, follow step 1, 2 and 3 above. And then push card inward to pop-out it from the slot.

remove CFast card



remove SIM card



3.3 Hard Disk Drive and PCIe Card Installation

3.3.1 Removing Bottom Cover

1. Place the Box PC upside down. Unscrew the six screws which secure the bottom cover.

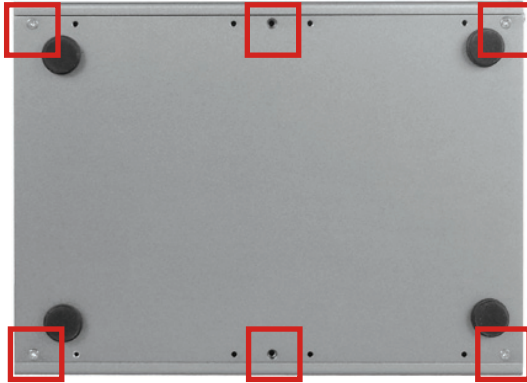

2. Use screwdriver to remove the bottom cover screws and keep them safely for later use.

3.3.2 Installing Hard Disk Drive

1. Remove the Bottom Cover.
2. Locate the four screws securing the HDD Holder Bracket to the main unit.
3. Unscrew the screws and remove the HDD Holder Bracket. Keep the screws safely for later use.

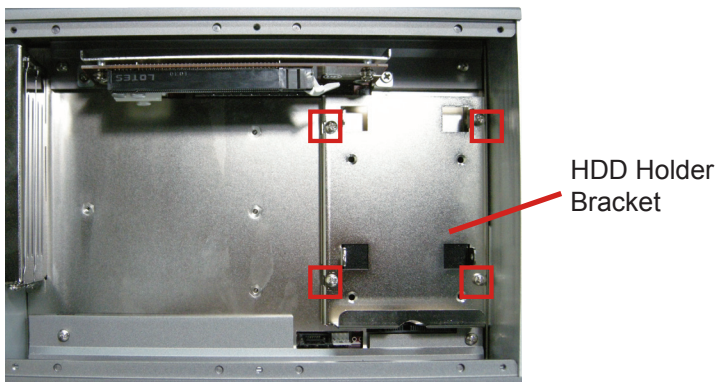

- Put the HDD into the HDD Holder Bracket and screw it on.
- Insert HDD adapter to the HDD connector.
- Hold the HDD Holder Bracket at an angle until the HDD adapter connect to the HDD connector on Main Board.

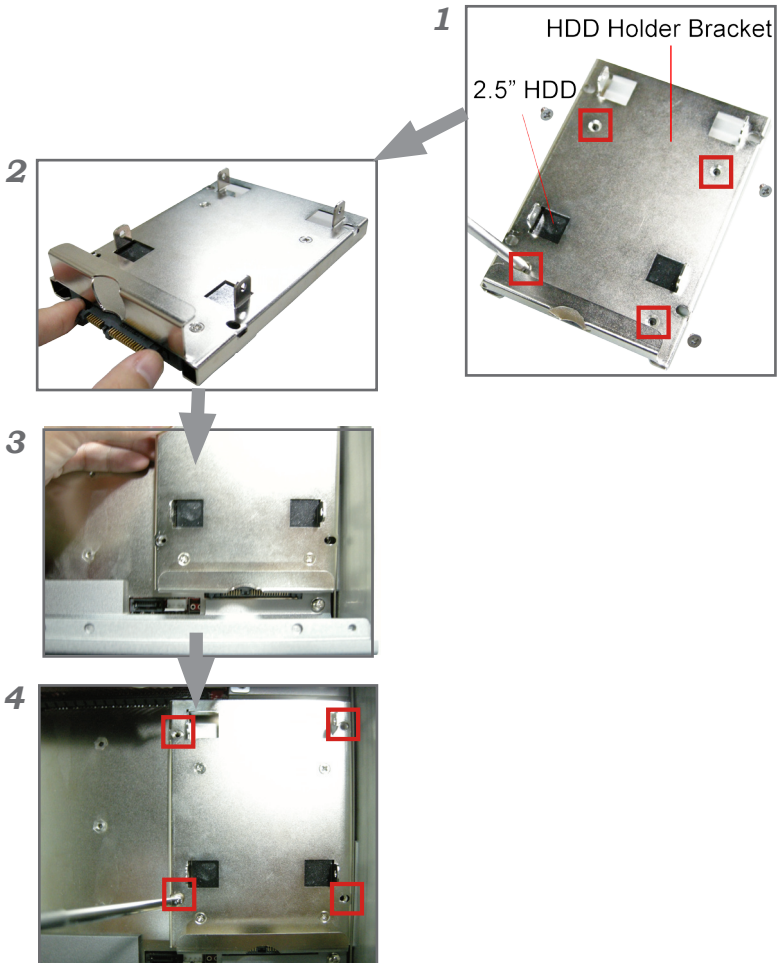

- Locate the four screws securing the HDD Holder Bracket to the main unit.
- Screw the HDD Holder Bracket on the Main Unit.
- You may also install a second HDD. Please unscrew the HDD Holder Bracket firstly.

10. Thread the cable used to connect main unit and HDD through the hole at one end of HDD Holder Bracket, so that the cable won't be jammed later on.

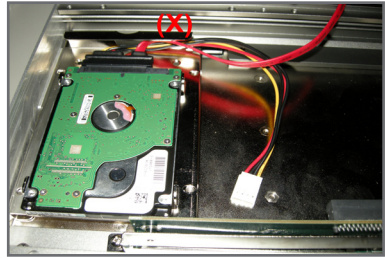
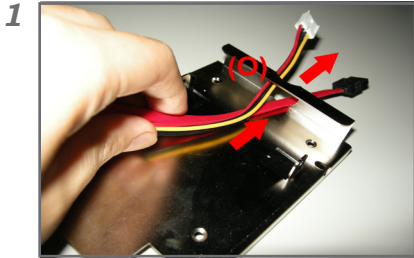

11. Plug the cable into HDD's jack, and then lock HDD onto the HDD Holder Bracket by screwing its four side corners.
12. Repeat Step 7-8 to load and screw HDD Holder Bracket.

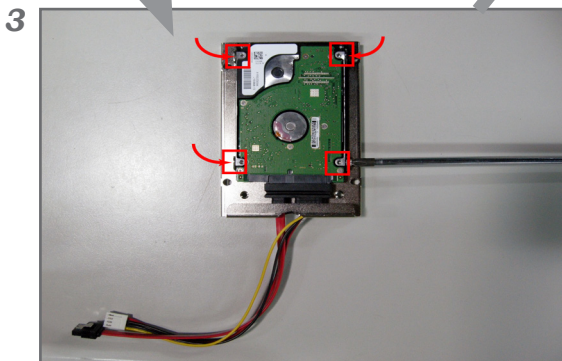
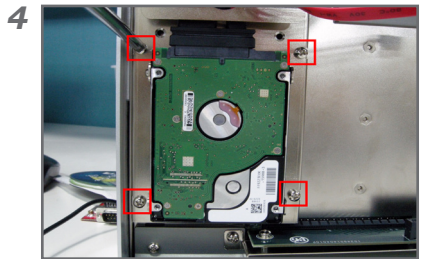
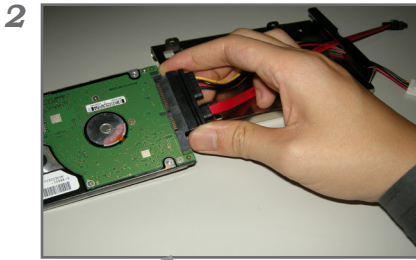

13. Plug power line and SATA line in corresponding PWR2 and SATA2 connectors separately.

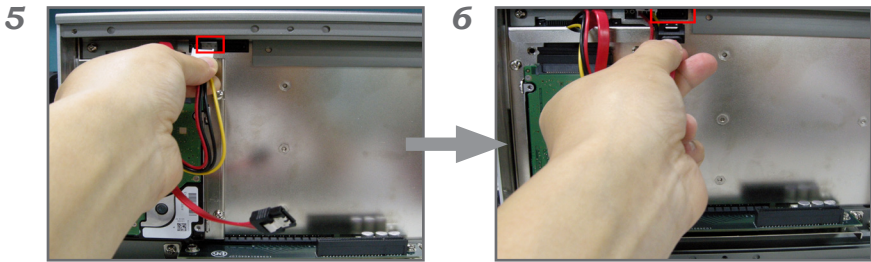

14. Be sure that SATA cable for second HDD is devised with a lockable function. Therefore, you have to use a tool to press against the little metal clip while you try to unplug SATA cable.

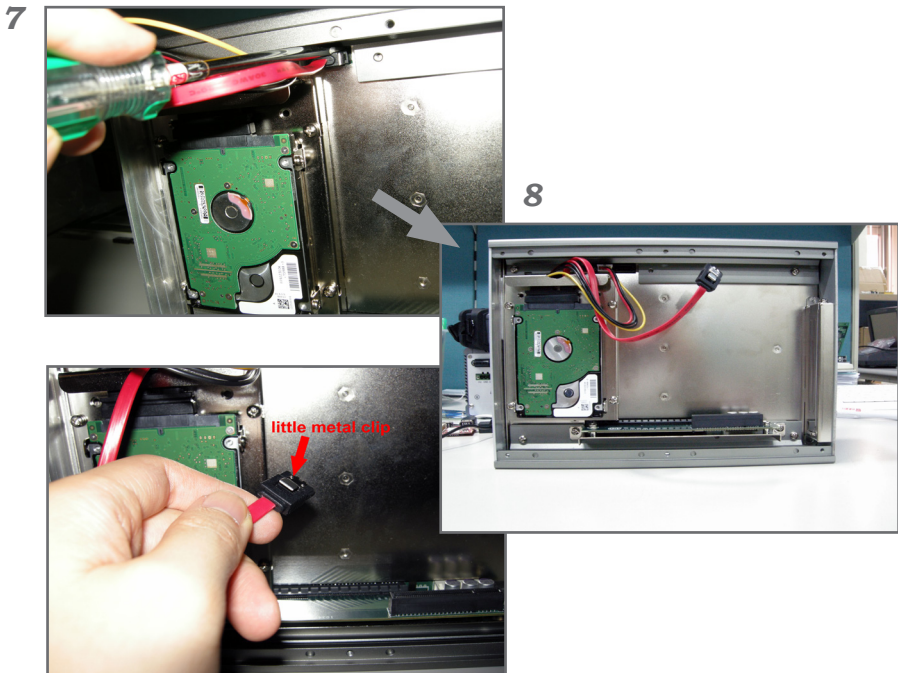

3.3.3 Installing PCIe Card

1. Use a crosshead screwdriver to loose the screw that secure the expansion slot bracket. And then you can install a PCIe card to this expansion slot.

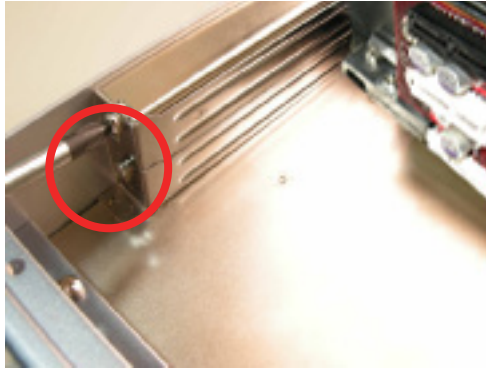

2. If you want to install the PCIe card to the lower slot, please push the rubber cover out of the unit and, through the hole, use the screwdriver to loose the screw securing the lower expansion slot bracket.

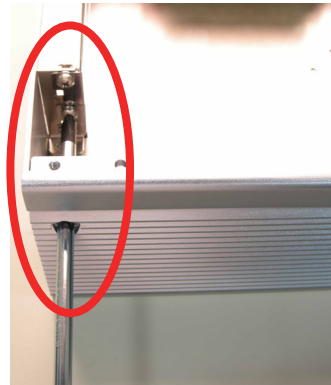
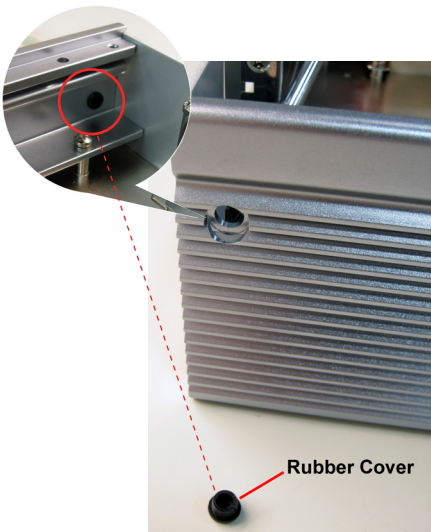

3.4 Wall Mounting

1. Place the main unit upside down on a flat surface and locate the 8 screw holes on the bottom cover.
2. Place the wall-mount brackets horizontally along with bottom cover so that the screw holes are aligned with the ones of the bottom cover.
3. Secure the brackets to the main unit with the accompanying screws.

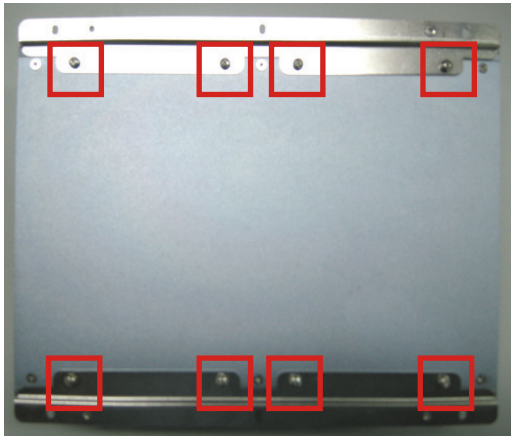

3.5 Grounding the Box PC

Follow the instructions below to ground the computer on the ground. Make sure to follow any grounding requirements at your site.



Warning When installing the unit, the ground connection must always be made first and disconnected last.

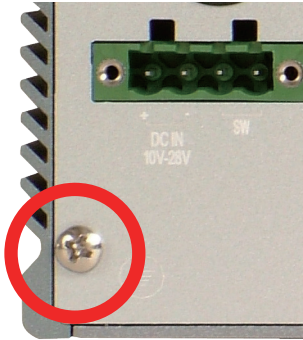

1. As the figure illustrates above, remove the ground screw located on the bottom left of the rear panel.
2. Attach the ground wire to the rear panel with the screw.

3.6 Wiring the DC-Input Power Source



Warning Only trained and qualified personnel should be allowed to install or replace this equipment.

Follow the instructions below for connecting the computer to a DC-input power source.

1. Before wiring, make sure the power source is disconnected.
2. Locate the terminal block that shipped in the accessory box with your computer.
3. Using the wire-stripping tool, strip a short piece of insulation from the output wires of the DC power source. The wire gauge must be in the range between 14-22 AWG.
4. Identify the positive and negative feed positions for the terminal block connection. See the symbols printed on the rear panel indicating the polarities and DC-input power range in voltage.
5. Insert the exposed wires into the terminal block plugs. Only wires with insulation should extend from the terminal block plugs. Note that the polarities between the wires and the terminal block plugs must be positive to positive and negative to negative.
6. Use a slotted screwdriver to tighten the captive screws. Plug the terminal block firmly, which wired, into the receptacle on the rear panel.

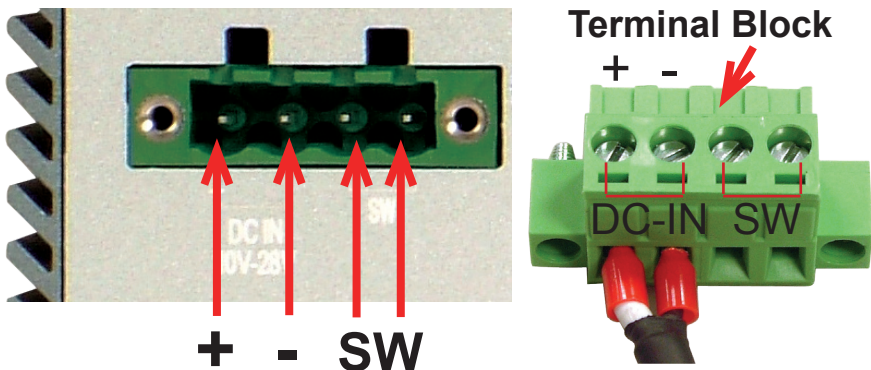



Chapter 4

BIOS

4.1 BIOS Main Setup

The AMI BIOS provides a setup utility program for specifying the system configurations and settings which are stored in the BIOS ROM of the system. When you turn on the computer, the AMI BIOS is immediately activated. After you have entered the setup utility, use the left/right arrow keys to highlight a particular configuration screen from the top menu bar or use the down arrow key to access and configure the information below.

NOTE: In order to increase system stability and performance, our engineering staff are constantly improving the BIOS menu. The BIOS setup screens and descriptions illustrated in this manual are for your reference only, and may not completely match what you see on your screen.

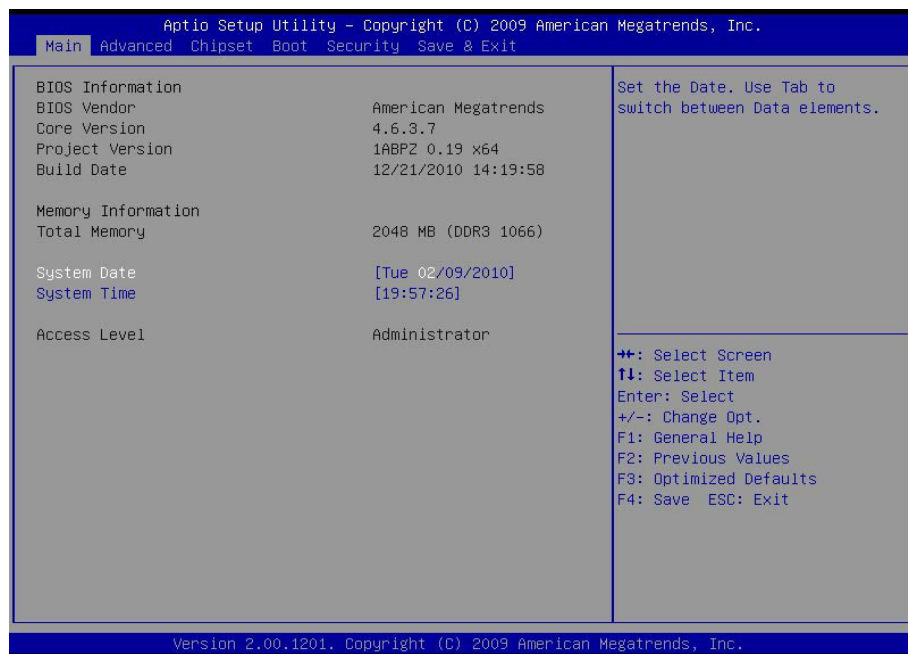

BIOS Information

Display the BIOS information.

System Date

Set the system date. Note that the 'Day' automatically changes when you set the date.

The date format is: **Day** : Sun to Sat
 Month : 1 to 12
 Date : 1 to 31
 Year : 1999 to 2099

System Time

Set the system time.

The time format is: **Hour** : 00 to 23
 Minute : 00 to 59
 Second : 00 to 59

4.2 Advanced Settings

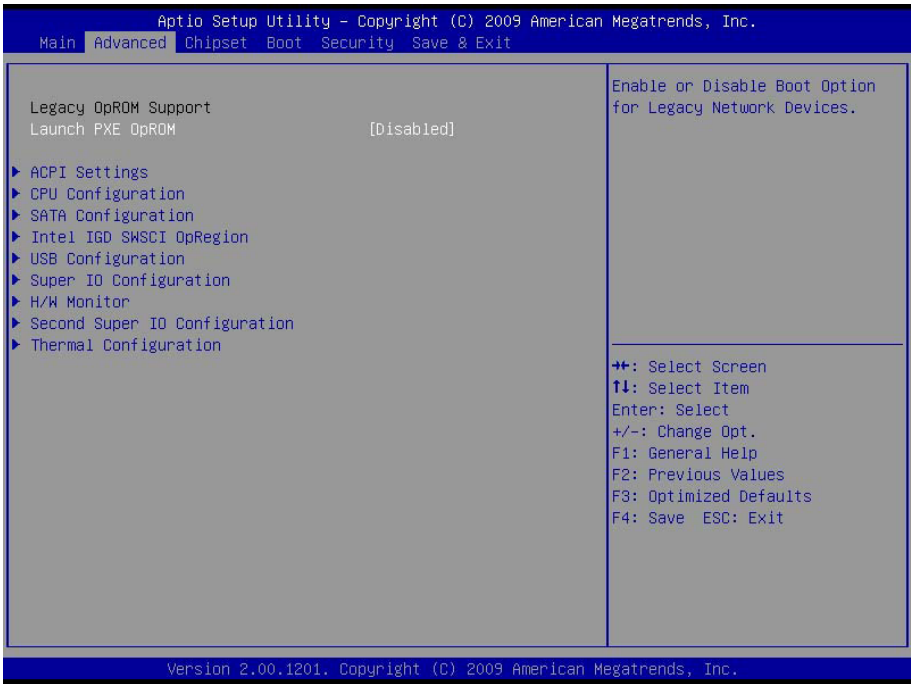

Launch PXE OpROM

Enable or disable the boot option for legacy network devices.

ACPI Settings

Enable/disable the Advanced Configuration and Power Interface (ACPI).

CPU Configuration

This section is used to configure the CPU. It will also display detected CPU information.

SATA Configuration

This section is used to configure the SATA drives.

Intel® IGD SWSCI OpRegion

Configure the Intel® graphics display.

USB Configuration

Configure the USB devices.

Super IO Configuration

This section is used to configure the I/O functions supported by the onboard Super I/O chip.

H/W Monitor

This section is used to configure the hardware monitoring events, such as temperature, fan speed and voltages.

Second Super IO Configuration

This section is used to configure the 2nd I/O functions supported by the onboard Super I/O chip.

Thermal Configuration

Configure the intelligent power sharing function.

4.2.1 ACPI Settings

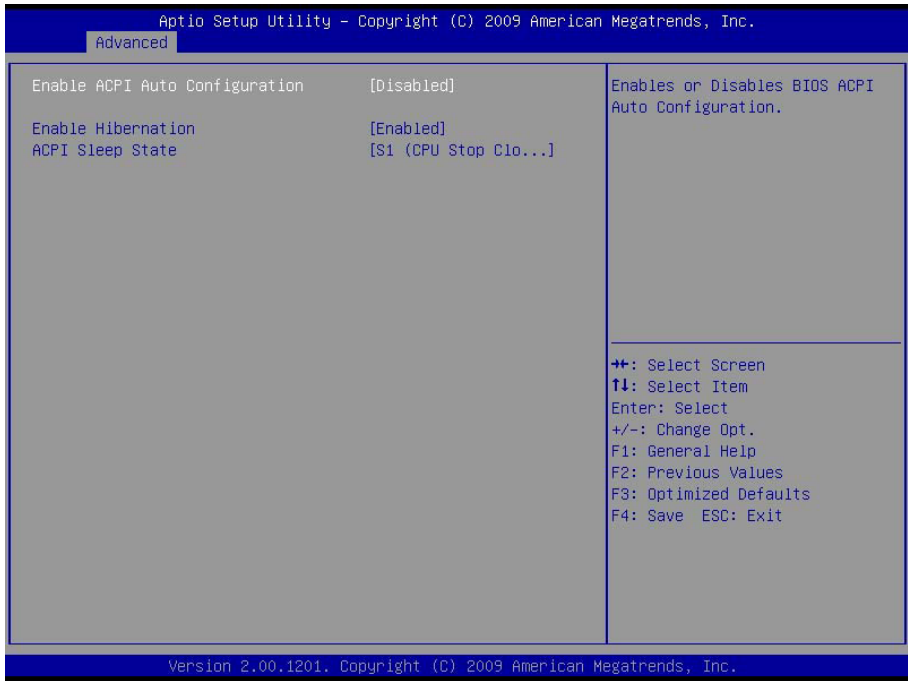

Enable ACPI Auto Configuration

This item allows you to enable/disable ACPI (Advanced Configuration and Power Interface) Auto Configuration.

Setting: Disabled (Default), Enabled.

Enable Hibernation

Enable or disable the Hibernation function. This allows the operating system to control power to the computer's disk, monitor and peripheral devices.

Setting: Enabled (Default), Disabled

ACPI Sleep State

This item allows you to select ACPI Sleep State.

ACPI sleep state enables you to send the system in a low-power consuming sleep mode.

4.2.2 CPU Configuration

The CPU Configuration setup screen varies depending on the installed processor.

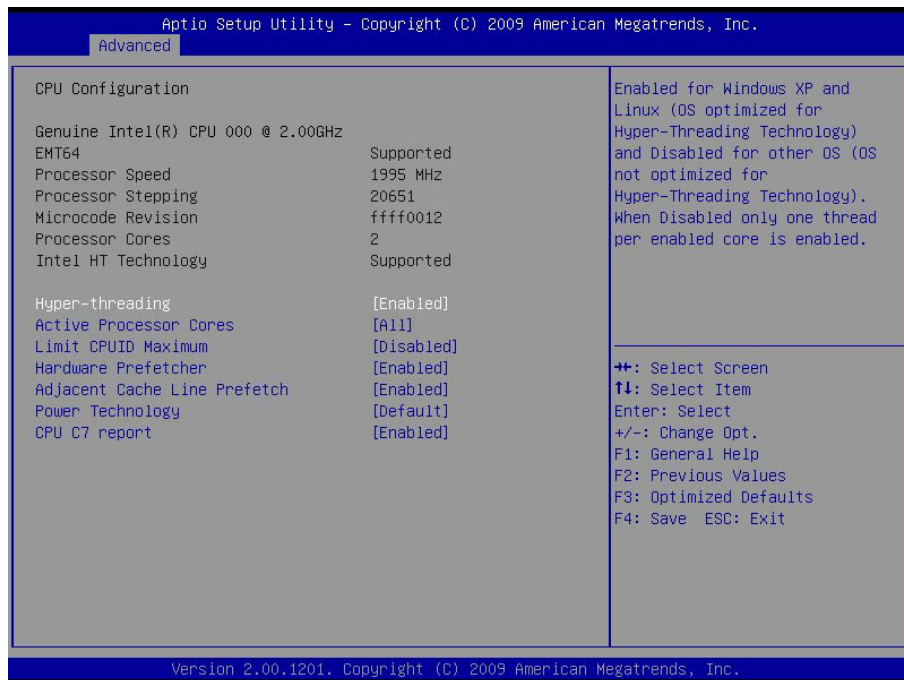

Hyper-threading

This item is used to enable or disable the processor's Hyper-threading feature.

Enabled for Windows XP and Linux (OS optimized for Hyper-threading Technology) and disabled for other OS (OS not optimized for Hyper-threading Technology).

When disabled, only one thread per enabled core is enabled.

Active Processor Cores

Enter the number of cores to enable in each processor package.

Limit CPUID Maximum

Enable or disable the Limit CPUID Maximum.

Hardware Prefetcher

Turn on or off the MLC streamer prefetcher.

Adjacent Cache Line Prefetch

Use this item to enable or disable the adjacent cache line prefetch function.

Power Technology

Configure the power management features.

CPU C7 Report

Enable or disable the CPU C7 Report.

4.2.3 SATA Configuration

It allows you to select the operation mode for SATA controller.

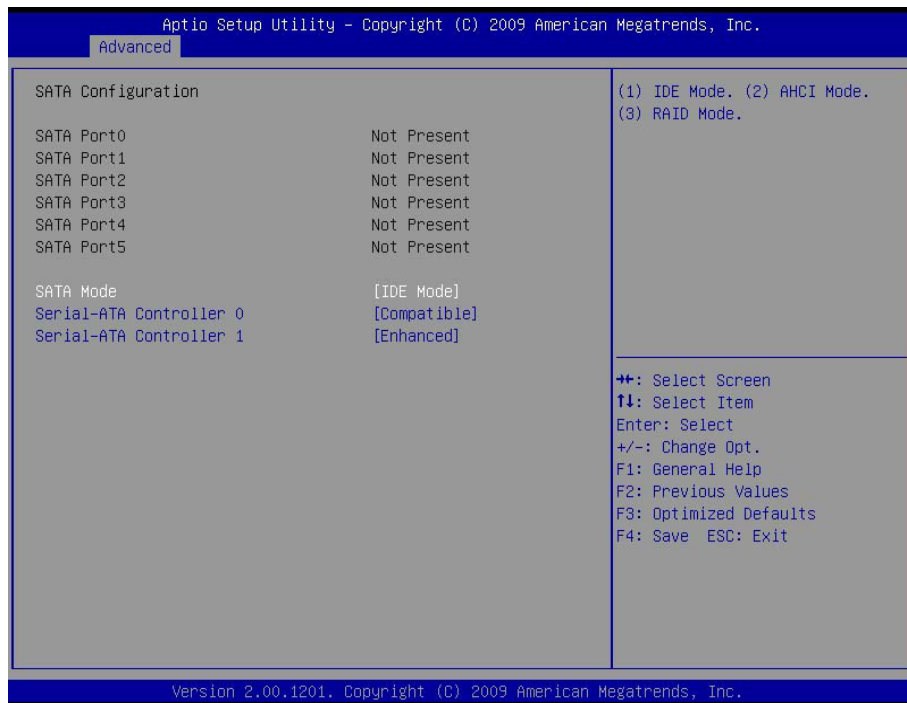

SATA Mode

Settings: Disable; IDE Mode (Default), AHCI Mode, RAID Mode

IDE Mode: Set the Serial ATA drives as Parallel ATA storage devices.

AHCI Mode: Allow the Serial ATA devices to use AHCI (Advanced Host Controller Interface).

RAID Mode: Create RAID or Intel Matrix Storage configuration on Serial ATA devices.

Serial-ATA Controller 0

Settings: [Disabled] [Enhanced] [Compatible]

Serial-ATA Controller 1

Settings: [Disabled] [Enhanced]

4.2.4 Intel® IGD SWSCI OpRegion Configuration

Select DVMT/FIXED mode memory size used by Internal Graphics Device.

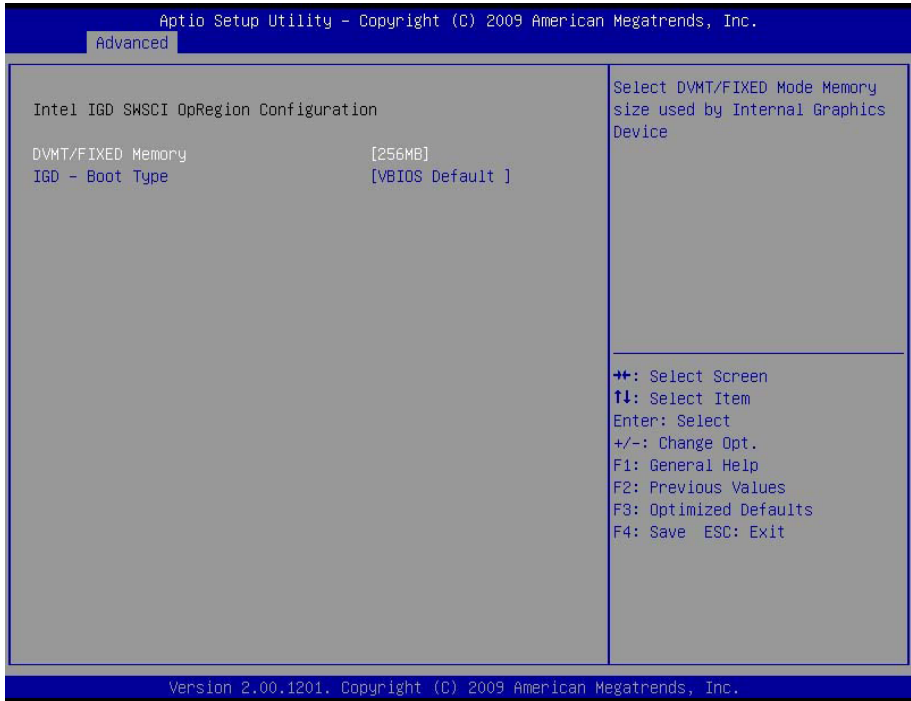

DVMT/FIXED Memory [256 MB]

IGD - Boot Type [VBIOS Default]

This option allows you to select the display device when you boot up the system.

4.2.5 USB Configuration

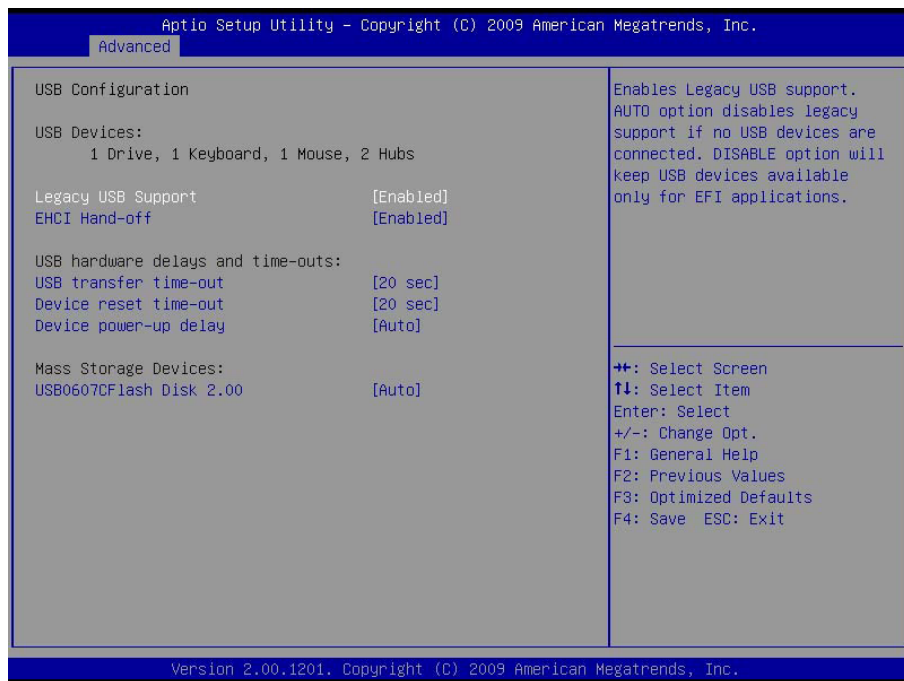

Legacy USB Support

Enables support for legacy USB. AUTO option disables legacy support if no USB devices are connected. Settings: Enabled (Default); Auto; Disabled

EHCI Hand-Off

Allows you to enable support for operating systems without an EHCI hand-off feature. Do not disable the BIOS EHCI Hand-Off option if you are running a Windows® operating system with USB device.

Settings: Enabled (Default); Disabled

USB Hardware Delays and Time-outs

USB Transfer Time-out Default setting: 20 sec

Device Reset Time-out Default setting: 20 sec

Device Power Delay Settings: Auto (Default); Manual

Mass Storage Devices

This item displays information when USB devices are detected.

4.2.6 Super IO Configuration

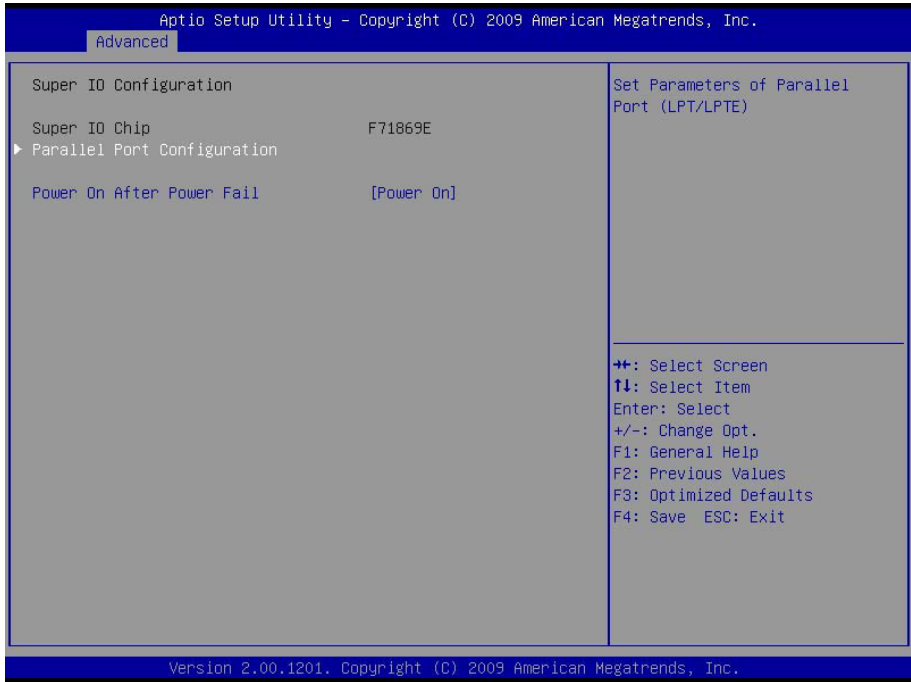

Parallel Port Configuration

This allows you to set parameters of Parallel Port (LPT/LPTE).

Power On After Power Fail

After Power Failure is a power management option that will set the mode of operation if a power loss occurs.

Settings:

Power Off: Keep the power off until the power button is pressed.

Power On: Restore power to the computer.

4.2.7 PC Health Status

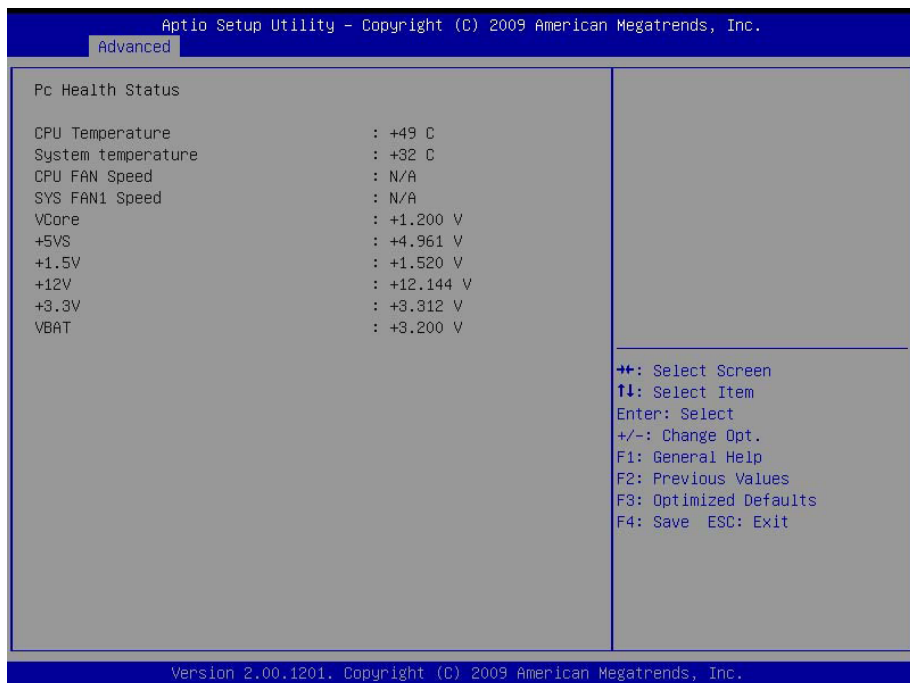

PC Health Status

The hardware monitor menu shows the operating temperature, fan speeds and system voltages.

4.2.8 Second Super IO Configuration

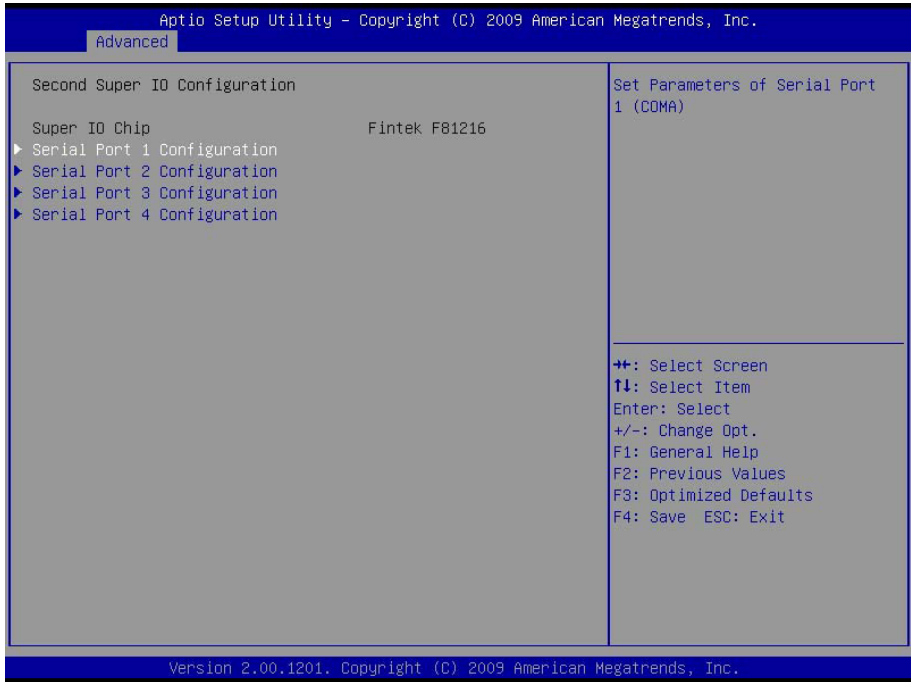

Serial Port Configuration

Use the Serial Port option to enable or disable the serial port.

4.2.9 Platform Thermal Configuration

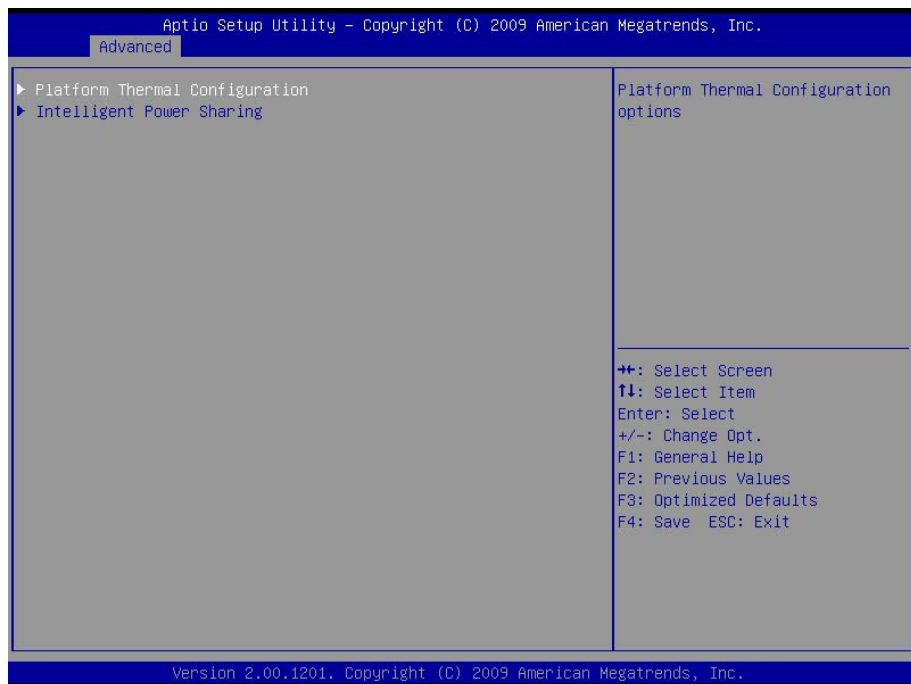

Intelligent Power Sharing

Enable or disable the power sharing function.

4.3 Chipset Settings

This submenu allows you to configure the specific features of the chipset installed on your system. The chipset manage bus speeds and access to system memory resources, such as DRAM. It also coordinates communications with the PCI bus.

Notice

Beware of that setting inappropriate values in items of this menu may cause system to malfunction.

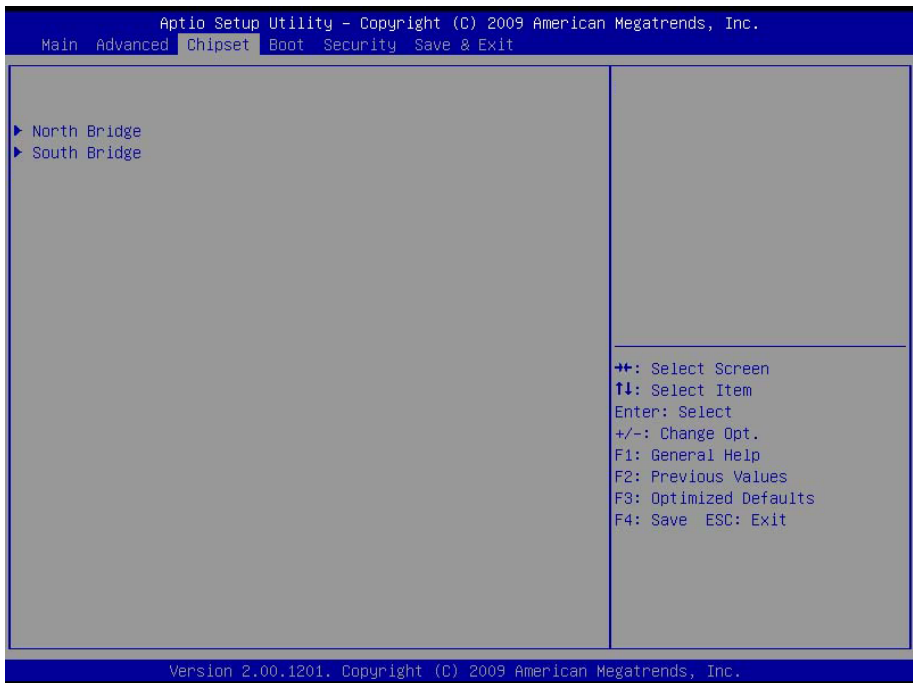

4.3.1 North Bridge

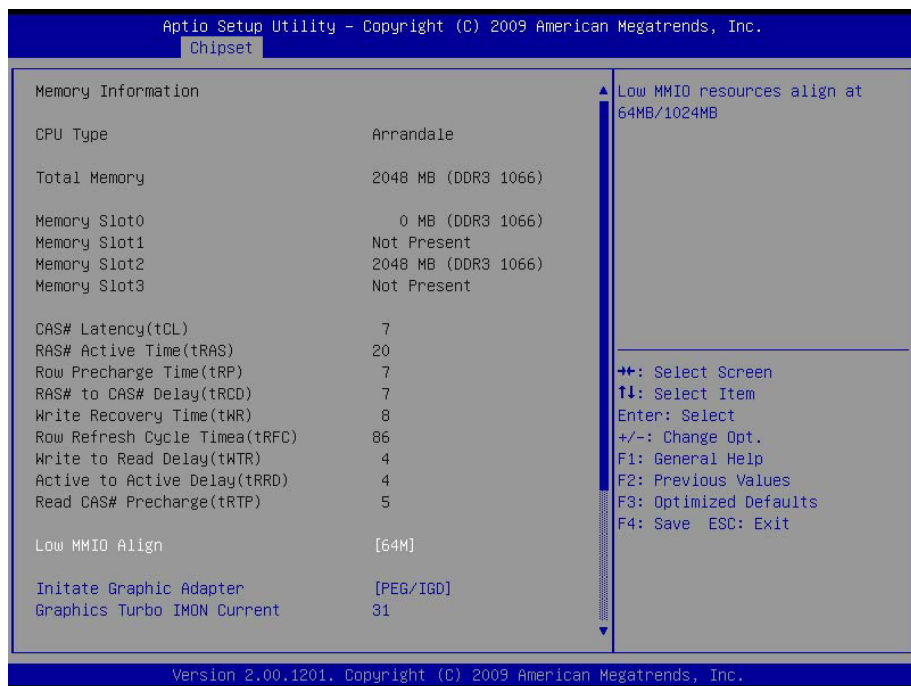

Memory Information

The item displays the detected system memory information.

Low MMIO Align

This option will determine Low MMIO resources align.

Initiate Graphic Adapter

This item allows you to select which graphics controller to use as the primary boot device.

Graphics Turbo IMON Current

Graphics turbo IMON current values supported.

4.3.2 South Bridge Configuration

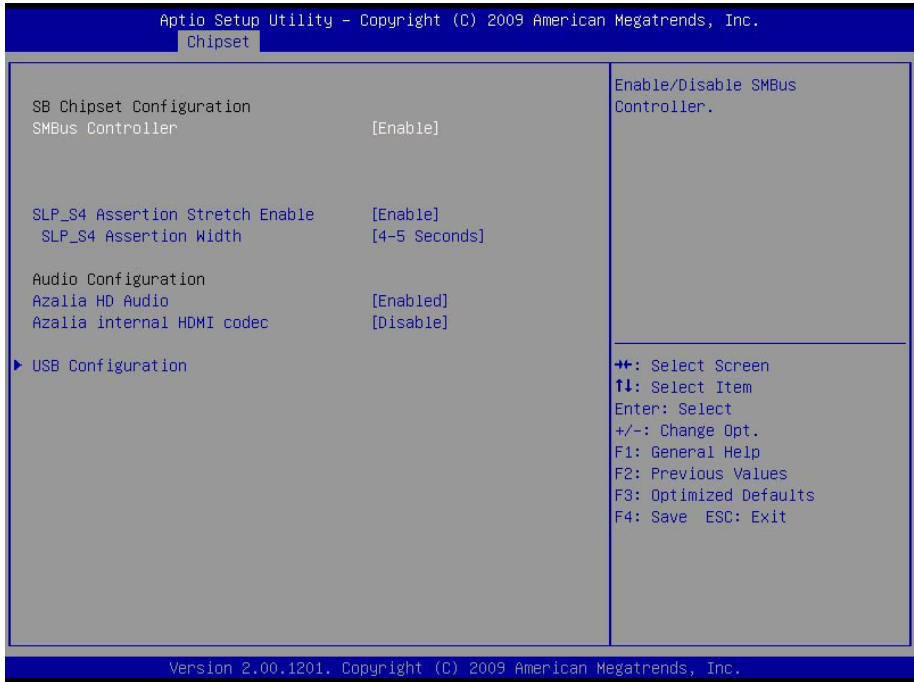

SMBus Controller

Enable or disable the SMBus controller.

SLP_S4 Assertion Stretch Enable

Enable or disable the SLP_S4 Stretch function.

Azalia HD Audio

Use the Azalia HD Audio option to enable or disable the High Definition Audio controller.

Azalia Internal HDMI Codec

Enable or disable the Azalia internal HDMI Codec.

USB Configuration

Enable or disable USB device.

4.4 Boot Settings

The Boot menu items allow you to change the system boot options.

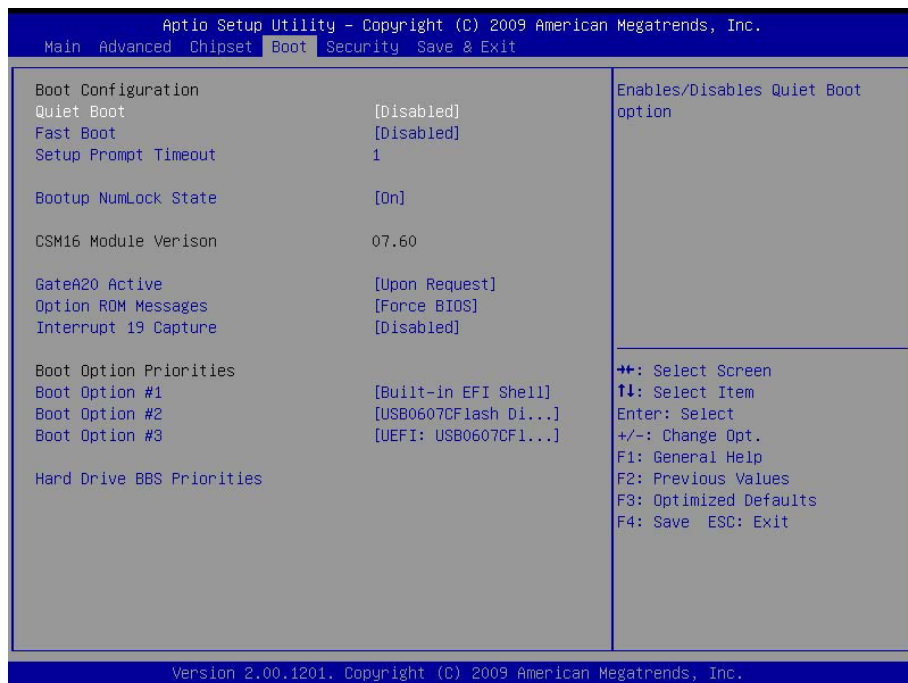

Quiet Boot

This allows you to select the screen display when the system boots.

Fast Boot

During the POST (Power On Self Test), the BIOS checks the hardware devices and counts the system memory. But all of these system tests are needed every time you boot, and can be turned off to save time. When set to Enabled, this option shortens POST by eliminating some tests.

Setup Prompt Timeout

Select the number of seconds to wait for the setup activation key.

Bootup NumLock State

This setting determines whether the Num Lock key should be activated at boot up.

Gate A20 Active

This item is to set the Gate A20 status.

Option ROM Messages

This item is to set display mode for Option ROM.

Interrupt 19 Capture

When enabled, it allows the optional ROM to trap interrupt 19.

Boot Option Priorities

Select the boot sequence of the hard drives.

Hard Drive BBS Priorities

This allows you to set the hard drive boot priority. The BIOS will attempt to arrange the hard disk boot sequence automatically. You can also change the booting sequence. The number of device items that appears on the screen depends on the number of devices installed in the system.

4.5 Security



Administrator Password

Use the Administrator Password to set or change a administrator password.

ENTER PASSWORD

Type the password, up to eight characters in length, and press <Enter>. The password typed now will clear any previously entered password from CMOS memory. You will be asked to confirm the password. Type the password again and press <Enter>. You may also press <ESC> to abort the selection and not enter a password.

To disable a password, just press <Enter> when you are prompted to enter the password. A message will confirm the password will be disabled. Once the password is disabled, the system will boot and you can enter Setup freely.

PASSWORD DISABLED

When a password has been enabled, you will be prompted to enter it every

time you try to enter Setup. This prevents an unauthorized person from changing any part of your system configuration.

Additionally, when a password is enabled, you can also require the BIOS to request a password every time your system is rebooted. This would prevent unauthorized use of your computer.

You can determine when the password is required within the BIOS Features Setup Menu and its Security option. If the Security option is set to “System”, the password will be required both at boot and at entry to Setup. If it’s set to “Setup”, prompting only occurs when trying to enter Setup.

4.6 Save & Exit

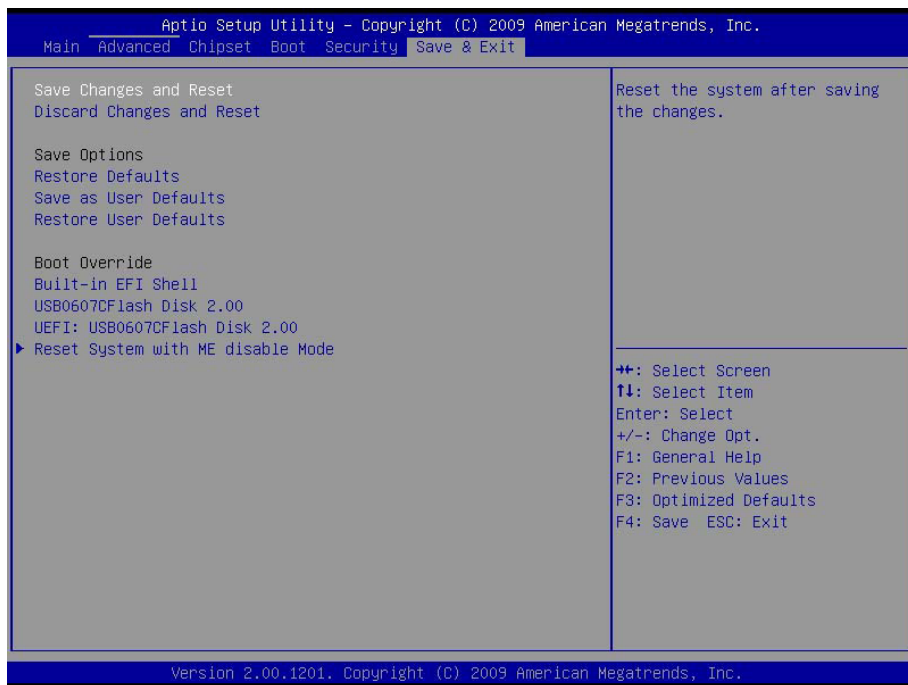

Save Changes and Reset

Pressing <Enter> on this item and it asks for confirmation:

Save configuration changes and exit setup?

Pressing <OK> stores the selection made in the menus in CMOS - a special section of memory that stays on after you turn your system off. The next time you boot your computer, the BIOS configures your system according to the Setup selections stored in CMOS. After saving the values the system is restarted again.

Discard Changes and Reset

Exit system setup without saving any changes.
<ESC> key can be used for this operation.

Save Options

Restore Defaults

Restore system to factory default.

Pressing <Enter> on this item and it asks for confirmation prior to executing this command.

Save as User Defaults

Save all current settings as user default. The current setup state can later be restored using Restore User Defaults.

Pressing <Enter> on this item and it asks for confirmation prior to executing this command.

Restore User Defaults

Restore system to settings previously stored by Save as User Defaults.

Pressing <Enter> on this item and it asks for confirmation prior to executing this command.

Boot Override

This group of functions includes a list of tokens, each of them corresponding to one device within the boot order. Select a drive to immediately boot that device regardless of the current boot order.

This page is intentionally left blank.



Appendix

Appendix A: I/O Port Address Map

Each peripheral device in the system is assigned a set of I/O port addresses which also becomes the identity of the device.

The following table lists the I/O port addresses used.

Address	Device Description
00000000 - 00000CF7	PCI bus
00000000 - 00000CF7	Direct memory access controller
00000010 - 0000001F	Motherboard resources
00000020 - 00000021	Programmable interrupt controller
00000022 - 0000003F	Motherboard resources
00000040 - 00000043	System Timer
00000044 - 0000005F	Motherboard resources
00000060 - 00000060	Standard 101/102-Key or Microsoft Natural PS/2 Keyboard
00000061 - 00000061	System speaker
00000062 - 00000063	Motherboard resources
00000064 - 00000064	Standard 101/102-Key or Microsoft Natural PS/2 Keyboard
00000065 - 0000006F	Motherboard resources
00000070 - 00000071	System CMOS/real time clock
00000072 - 0000007F	Motherboard resources
00000080 - 00000080	Motherboard resources
00000081 - 00000083	Direct memory access controller
00000084 - 00000086	Motherboard resources
00000087 - 00000087	Direct memory access controller
00000088 - 00000088	Motherboard resources
00000089 - 0000008B	Direct memory access controller
0000008C - 0000008E	Motherboard resources
0000008F - 0000008F	Direct memory access controller
00000090 - 0000009F	Motherboard resources
000000A0 - 000000A1	Programmable interrupt controller

Appendix

000000A2 - 000000BF	Motherboard resources
000000C0 - 000000DF	Direct memory access controller
000000E0 - 000000EF	Motherboard resources
000000F0 - 000000FF	Numeric data processor
00000274 - 00000277	ISAPNP Read Data Port
00000279 - 00000279	ISAPNP Read Data Port
00000290 - 0000029F	Motherboard resources
000002E8 - 000002EF	Communications Port (COM4)
000002F8 - 000002FF	Communications Port (COM2)
00000378 - 0000037F	Printer Port (LPT1)
000003B0 - 000003BB	Intel(R) HD Graphics
000003C0 - 000003DF	Intel(R) HD Graphics
000003E8 - 000003EF	Communications Port (COM3)
000003F8 - 000003FF	Communications Port (COM1)
00000400 - 0000047F	System board
000004D0 - 000004D1	Motherboard resources
00000500 - 0000057F	System board
00000A79 - 00000A79	ISAPNP Read Data Port
00000D00 - 0000FFFF	PCI bus
00001180 - 0000119F	System board
0000D000 - 0000DFFF	Intel(R) 5 Series/3400 Series Chipset Family PCI Express Root Port 6 - 3B4C
0000D000 - 0000DFFF	Intel(R) 82574L Gigabit Network Connection
0000E000 - 0000EFFF	Intel(R) 5 Series/3400 Series Chipset Family PCI Express Root Port 2 - 3B44
0000E000 - 0000EFFF	Intel(R) 82574L Gigabit Network Connection #2
0000F000 - 0000F01F	Intel(R) 5 Series/3400 Series Chipset Family SMBus Controller - 3B30
0000F020 - 0000F03F	Intel(R) 5 Series 6 Port SATA AHCI Controller
0000F040 - 0000F043	Intel(R) 5 Series 6 Port SATA AHCI Controller
0000F050 - 0000F057	Intel(R) 5 Series 6 Port SATA AHCI Controller
0000F060 - 0000F063	Intel(R) 5 Series 6 Port SATA AHCI Controller

0000F070 - 0000F077 Intel(R) 5 Series 6 Port SATA AHCI Controller

0000F080 - 0000F087 Intel(R) HD Graphics

Appendix B: Interrupt Request Lines (IRQ)

Peripheral devices use interrupt request lines to notify CPU for the service required. The following table shows the IRQ used by the devices on board.

Level	Function
IRQ 0	System Timer
IRQ 1	Standard 101/102-Key or Microsoft Natural PS/2 Keyboard
IRQ 3	Communications Port (COM2)
IRQ 3	Intel(R) 5 Series/3400 Series Chipset Family SMBus Controller - 3B30
IRQ 4	Communications Port (COM1)
IRQ 8	System CMOS/real time clock
IRQ 9	Microsoft ACPI-Compliant System
IRQ 10	Communications Port (COM3)
IRQ 11	Communications Port (COM4)
IRQ 12	Microsoft PS/2 Mouse
IRQ 13	Numeric data processor
IRQ 16	Intel(R) HD Graphics
	Intel(R) Management Engine Interface
	Intel(R) 5 Series/3400 Series Chipset Family USB Enhanced Host Controller - 3B3C
IRQ 17	Intel(R) 5 Series/3400 Series Chipset Family PCI Express Root Port 1 - 3B42
	Intel(R) 82574L Gigabit Network Connection #2
	Intel(R) 82574L Gigabit Network Connection
IRQ 18	Intel(R) 5 Series/3400 Series Chipset Family PCI Express Root Port 2 - 3B44
	Intel(R) 5 Series/3400 Series Chipset Family PCI Express Root Port 6 - 3B4C

IRQ 19	Intel(R) 5 Series 6 Port SATA AHCI Controller Standard Dual Channel PCI IDE Controller
IRQ 22	Microsoft UAA Bus Driver for High Definition Audio
IRQ 23	Intel(R) 5 Series/3400 Series Chipset Family USB Enhanced Host Controller - 3B34

Appendix C: Memory Mapping

Address	Device Description
D0000000 - FFFFFFFF	PCI bus
D0000000 - FFFFFFFF	Intel(R) HD Graphics
FB400000 - FB7FFFFFFF	Intel(R) HD Graphics
FBC09000 - FBC0900F	Intel(R) Management Engine Interface
FBC08000 - FBC083FF	Intel(R) 5 Series/3400 Series Chipset Family USB Enhanced Host Controller - 3B3C
FBC00000 - FBC03FFF	Microsoft UAA Bus Driver for High Definition Audio
FBA00000 - FBBFFFFFFF	Intel(R) 5 Series/3400 Series Chipset Family PCI Express Root Port 2 - 3B44
FBA00000 - FBBFFFFFFF	Intel(R) 82574L Gigabit Network Connection #2
FBB00000 - FBB1FFFF	Intel(R) 82574L Gigabit Network Connection #2
FBB20000 - FBB23FFF	Intel(R) 82574L Gigabit Network Connection #2
FB800000 - FB9FFFFFFF	Intel(R) 5 Series/3400 Series Chipset Family PCI Express Root Port 6 - 3B4C
FB800000 - FB9FFFFFFF	Intel(R) 82574L Gigabit Network Connection
FB900000 - FB91FFFF	Intel(R) 82574L Gigabit Network Connection
FB920000 - FB923FFF	Intel(R) 82574L Gigabit Network Connection
FBC07000 - FBC073FF	Intel(R) 5 Series/3400 Series Chipset Family USB Enhanced Host Controller - 3B34
FBC06000 - FBC067FF	Intel(R) 5 Series 6 Port SATA AHCI Controller
FBC05000 - FBC050FF	Intel(R) 5 Series/3400 Series Chipset Family SMBus Controller - 3B30
FED14000 - FED19FFF	System board
E0000000 - EFFFFFFF	System board

FED90000 - FED93FFF	System board
FED20000 - FED3FFFF	System board
FEE00000 - FEE0FFFF	System board
FED1C000 - FED1FFFF	System board
FEC00000 - FECFFFFFF	System board
FED08000 - FED08FFF	System board
FF000000 - FFFFFFFF	System board
A0000 - BFFFF	PCI bus
A0000 - BFFFF	Intel(R) HD Graphics

Appendix D: Digital I/O Setting

Digital I/O can read from or write to a line or an entire digital port, which is a collection of lines. This mechanism can be used to meet user's various applications such as industrial automation, customized circuit, and laboratory testing. The source code below written in C is the applicable sample for programming.

```
/*----- Include Header Area -----*/
#include "math.h"
#include "stdio.h"
#include "dos.h"

void main(void){

    int SMB_PORT_AD = 0xF000;
    int SMB_DEVICE_ADD = 0x6E;          /*75111R's Add=6eh */

    //programming DIO as output
    //0:input 1:Output

    /*      Index 10, GPIO1x Output pin control      */
    SMB_Byte_WRITE(SMB_PORT_AD,SMB_DEVICE_ADD,0x10,0xff);
    delay(10);
    /*      Index 20, GPIO2x Output pin control      */
    SMB_Byte_WRITE(SMB_PORT_AD,SMB_DEVICE_ADD,0x20,0xff);
    delay(10);

    /*      Index 40, GPIO3x Output pin control      */
    SMB_Byte_WRITE(SMB_PORT_AD,SMB_DEVICE_ADD,0x40,0xff);
    delay(10);

    //programming DIO default LOW

    /*      Index 11, GPIO1x Output Data value      */
    SMB_Byte_WRITE(SMB_PORT_AD,SMB_DEVICE_ADD,0x11,0x00);
    delay(10);
    /*      Index 21, GPIO2x Output Data value      */
    SMB_Byte_WRITE(SMB_PORT_AD,SMB_DEVICE_ADD,0x21,0x00);
    delay(10);
```

```
/*      Index 41, GPIO3x Output Data value      */
SMB_Byte_WRITE(SMB_PORT_AD,SMB_DEVICE_ADD,0x41,0x00);
delay(10);
}
//-----
unsigned char SMB_Byte_READ (int SMPORT, int DeviceID, int REG_IN-
DEX)
{
  unsigned char SMB_R;
  outportb(SMPORT+02, 0x00);          /* clear */
  outportb(SMPORT+00, 0xff);         /* clear */
  delay(10);
  outportb(SMPORT+04, DeviceID+1);   /* clear */
  outportb(SMPORT+03, REG_INDEX);    /* clear */
  outportb(SMPORT+02, 0x48);         /* read_byte */
  delay(10);
  SMB_R= inportb(SMPORT+05);
  return SMB_R;
}

void SMB_Byte_WRITE(int SMPORT, int DeviceID, int REG_INDEX, int
REG_DATA)

{
  outportb(SMPORT+02, 0x00);          /* clear */
  outportb(SMPORT+00, 0xff);         /* clear */
  delay(10);
  outportb(SMPORT+04, DeviceID);     /* clear */
  outportb(SMPORT+03, REG_INDEX);    /* clear */
  outportb(SMPORT+05, REG_DATA);     /* read_byte */
  outportb(SMPORT+02, 0x48);         /* read_byte */
  delay(10);
}
```

Appendix E: Watchdog Timer (WDT) Setting

WDT is widely applied to industry computers to monitor activities of CPU. The programmed application triggers WDT with adequate timer setting depending on its requirement. Before WDT counts down to zero, the functional system will reset the counter. In case the WDT counter is not reset by an abnormal system, it will counts down to zero and then reset the system automatically.

This computer supports the watchdog timer up to 255 levels for users for software programming. Below please take the source code written in C for a WDT application example.

```

/*----- Include Header Area -----*/
#include "math.h"
#include "stdio.h"
#include "dos.h"

/**----- index port 0x2e -----*/
void main()
{
    outportb(0x2e, 0x87);      /* initial IO port */
    outportb(0x2e, 0x87);    /* twice, */

    outportb(0x2e, 0x07);    /* point to logical device */
    outportb(0x2e+1, 0x07);  /* select logical device 7 */
    outportb(0x2e, 0xf5);    /* select offset f5h */
    outportb(0x2e+1, 0x40);  /* set bit5 = 1 to clear bit5 */
    outportb(0x2e, 0xf0);    /* select offset f0h */
    outportb(0x2e+1, 0x81);  /* set bit7 =1 to enable WDTRST# */
    outportb(0x2e, 0xf6);    /* select offset f6h */
    outportb(0x2e+1, 0x05);  /* update offset f6h to 0ah :10sec */
    outportb(0x2e, 0xF5);    /* select offset f5h */
    outportb(0x2e+1, 0x20);  /* set bit5 = 1 enable watch dog time */

    outportb(0x2e, 0xAA);    /* stop program F71869E, Exit */
}

```