

Neosys Technology Inc.

Nuvo-5095GC Series

*Compact and Wide-Temperature GPU Computing Platform with
nVidia® GeForce® GTX 950/1050 and 6th-Gen Intel® Core™ Processor*

User's Manual

Rev. A1

Published Feb 14th, 2017



Revision History

Date	Change List	Version
2017/2/14	First formal release	A1



Disclaimer.....	6
Declaration of Conformity.....	6
FCC.....	6
CE.....	6
Copyright and Trademarks.....	6
Chapter 1 Introduction.....	7
1.1 Overview.....	7
1.2 Product Specification.....	8
1.2.1 Specification of Nuvo-5095GC.....	8
1.3 List of Supported CPU.....	10
1.4 List of Supported Graphics Card.....	11
Chapter 2 Getting to Know your Nuvo-5095GC.....	12
2.1 Unpacking your Nuvo-5095GC Controller.....	12
2.2 Front Panel I/O Functions.....	13
2.2.1 Power Button.....	13
2.2.2 Reset Button.....	14
2.2.3 LED Indicators.....	14
2.2.4 Gigabit Ethernet Port.....	15
2.2.5 Remote On/Off Control and Status LED Output.....	16
2.2.6 USB 3.0 Connectors.....	17
2.2.7 DVI/HDMI Connectors.....	18
2.2.8 VGA Connector.....	19
2.2.9 DisplayPort.....	20
2.3 Back Panel I/O Functions.....	21
2.3.1 3-Pin Terminal Block for DC and IGN Input.....	21
2.3.2 COM Ports (COM1 / COM2 / COM3).....	22
2.3.3 USB2.0 Connectors.....	23
2.3.4 Speaker-out and Mic-in Audio Jacks.....	23
2.3.5 MezIO™ I/O Connector.....	24
2.3.6 SIM Socket.....	24
2.4 Internal I/O Functions.....	25
2.4.1 DDR4 SODIMM Sockets.....	25
2.4.2 mSATA / mini-PCIe #1 Dual-Mode Socket.....	26
2.4.3 Mini-PCIe #2 Socket.....	28
2.4.4 Internal SATA Port #1.....	30
2.4.5 Internal SATA Port #2.....	31
2.4.6 Internal USB Port.....	32
2.5 MezIO™ Interface.....	33
2.5.1 Pin Definition of MezIO™ Interface.....	33



2.5.2 MezIO™ Module for Nuvo-5095GC Series.....	35
2.6 Expansion Cassette for GPU.....	37
2.6.1 Inside the Cassette of Nuvo-5095GC.....	38
2.7 Mechanical Dimension.....	39
2.7.1 Top View of Nuvo-5095GC Series.....	39
2.7.2 Front View of Nuvo-5095GC Series.....	40
2.7.3 Side View of Nuvo-5095GC Series.....	40
2.7.4 Bottom View of Nuvo-5095GC Series.....	41
Chapter 3 Getting Start.....	42
3.1 Disassemble your Nuvo-5095GC Controller.....	42
3.2 Install and Replace LGA1151 CPU.....	44
3.2.1 Install a CPU on Nuvo-5095GC.....	44
3.2.2 Replace the CPU on Nuvo-5095GC.....	48
3.3 Install DDR4 SODIMM Module.....	51
3.4 Install 2.5" SATA HDD/SSD.....	52
3.5 Install Mini-PCIe Module.....	54
3.6 Install MezIO™ Module.....	56
3.7 Install nVidia® Graphics Card in Cassette.....	58
3.8 Mount your Nuvo-5095GC.....	61
3.9 Connect DC Power to your Nuvo-5095GC.....	63
3.10 Power on your Nuvo-5095GC Controller.....	64
3.10.1 Power on Nuvo-5095GC Using the Power Button.....	64
3.10.2 Power on Nuvo-5095GC Using an External Switch.....	64
3.10.3 Power on Nuvo-5095GC Using Wake-on-LAN Function.....	65
Chapter 4 BIOS and Driver.....	68
4.1 BIOS Settings.....	68
4.1.1 COM Port Configuration.....	69
4.1.2 SATA Port Configuration.....	70
4.1.3 Enable TPM Feature.....	71
4.1.4 Configure CPU SKU Power.....	72
4.1.5 Wake-on-LAN Option.....	73
4.1.6 Power On after Power Failure Option.....	74
4.1.7 Configure Legacy/UEFI Boot Type.....	75
4.1.8 Position New Boot Device.....	76
4.1.9 Watchdog Timer for Booting.....	77
4.1.10 Select a Boot Device.....	79
4.2 Configure AMT.....	80
4.3 Configure RAID Volume.....	81
4.4 Operating System Support.....	82
4.5 Driver Installation.....	83



4.5.1 Install All Drivers Using “One-Click” Driver Installation.....	83
4.5.2 Install Drivers Manually.....	84
4.5.3 Install Driver for WDT and Per-port PoE On/Off Control.....	86
Appendix A Install Windows 7 on Nuvo-5095GC.....	87
A.1 Before We Start	87
A.2 Create USB Flash Drive Installer Step-by-Step.....	87
Step 1 - Create .ISO file from Windows 7 DVD.....	87
Step 2 - Create USB flash drive installer from .ISO.....	88
Step 3 - Create working folder on your local drive.....	89
Step 4 - Execute batch file to patch .wim files.....	90
Step 5 - Install Windows 7 using USB flash drive installer.....	91
Appendix B Using Watchdog Timer.....	92
Install WDT_DIO Library.....	92
WDT Function Reference.....	95



Disclaimer

This manual is intended to be used as a practical and informative guide only and is subject to change without prior notice. It does not represent commitment from Neosys Technology Inc. Neosys shall not be liable for direct, indirect, special, incidental, or consequential damages arising out of the use of the product or documentation, nor for any infringements upon the rights of third parties, which may result from such use.

Declaration of Conformity

FCC

This equipment has been tested and found to comply with the limits for a Class A digital device, pursuant to part 15 of the FCC Rules. These limits are designed to provide reasonable protection against harmful interference when the equipment is operated in a commercial environment. This equipment generates, uses, and can radiate radio frequency energy and, if not installed and used in accordance with the instruction manual, may cause harmful interference to radio communications. Operation of this equipment in a residential area is likely to cause harmful interference in which case the user will be required to correct the interference at his own expense.

CE

The product(s) described in this manual complies with all applicable European Union (CE) directives if it has a CE marking. For computer systems to remain CE compliant, only CE-compliant parts may be used. Maintaining CE compliance also requires proper cable and cabling techniques.

Copyright and Trademarks

This document contains proprietary information protected by copyright. All rights are reserved. No part of this document may be reproduced by any mechanical, electronic, or other means in any form without prior written permission of the manufacturer.

Company/product names mentioned herein are used for identification purposes only and are trademarks and/or registered trademarks of their respective companies.



Chapter 1 Introduction

1.1 Overview

Nuvo-5095GC opens a new chapter for industrial computers. As the first embedded controller targeting at emerging applications of CUDA computing, autopilot, artificial intelligence and virtual reality, Nuvo-5095GC integrates all features required for a compact, reliable and powerful GPU-computing platform.

Supporting nVidia® GeForce® GTX 950 and GTX 1050, Nuvo-5095GC possesses 768 CUDA cores to deliver tremendous computing power for arithmetic/graphics operations. Neosys' patented Cassette technology* and thermal dissipation design** help to effectively dissipate the heat generated by GPU, and make this compact system capable to operate reliably at 60°C with 100% GPU loading.

Nuvo-5095GC is based on Intel® Skylake platform, and supports 35W/65W 6th-Gen® Core™ processors and up to 32GB DDR4 memory. It offers rich I/O functions, such as GbE, USB 3.0 and COM ports, to connect external devices. All these extraordinary features are integrated into a very compact, 240 x 225 x 110 mm footprint.

For fast-growing GPU computing applications, Nuvo-5095GC presents the first industrial-grade, compact and rugged platform incorporating CPU and GPU to offer performance far beyond traditional industrial computers.



* R.O.C. Patent No. M456527

** R.O.C. Patent No. M534371

1.2 Product Specification

1.2.1 Specification of Nuvo-5095GC

System Core	
Processor	Supports the following CPU - Intel® Core™ i7-6700 (8M Cache, 3.4/4.0 GHz, 65W TDP)* - Intel® Core™ i5-6500 (6M Cache, 3.2/3.6 GHz, 65W TDP)* - Intel® Core™ i7-6700TE (8M Cache, 2.4/3.4 GHz, 35W TDP) - Intel® Core™ i5-6500TE (6M Cache, 2.3/3.3 GHz, 35W TDP)
Chipset	Intel® Q170 Platform Controller Hub
Graphics	Integrated Intel® HD Graphics 530
Memory	Up to 32 GB DDR4-2133 SDRAM by two SODIMM sockets
AMT	Supports AMT 11.0
TPM	Supports TPM 2.0
I/O Interface	
Ethernet	6x Gigabit Ethernet ports by Intel® I219 and 5x I210
Video Port	1x stacked VGA + DVI-D connector 2x DisplayPort connectors, supporting 4K2K resolution
USB	4x USB 3.0 ports via native XHCI controller 4x USB 2.0 ports
Serial Port	2x software-programmable RS-232/422/485 ports (COM1 & COM3) 1x RS-232 port (COM2)
Audio	1x Mic-in and 1x Speaker-out
Storage Interface	
SATA HDD	2x 6 Gb/s SATA 3.0 ports for 2.5" HDD/SSD installation, supporting RAID 0/1
mSATA	1x full-size mSATA port (mux with mini-PCIe)
Expansion Bus	
PCI/PCI Express	1x PCIe x16 slot @ Gen3, 8-lanes PCIe signals in Cassette for installing nVidia® GeForce® GTX 950 or GTX 1050
Mini PCI-E	1x internal mini PCI Express socket with panel-accessible SIM socket 1x internal mini PCI Express socket with internal SIM socket (mux with mSATA)
Expandable I/O	1x MezIO™ expansion port for Neosys' MezIO™ modules
Power Supply & Ignition Control	
DC Input	1x 3-pin pluggable terminal block for 8~35V DC input
Remote Ctrl. & LED Output	1x 10-pin (2x5) wafer connector for remote on/off control and status LED output



Max. Power Consumption	With Core™ i7-6700 & GTX 1050: 153.2W (7.66A@20V)*
Mechanical	
Dimension	240 mm (W) x 225 mm (D) x 111 mm (H)
Weight	4.8 kg (incl. CPU, GPU, memory and HDD)
Mounting	Wall-mount by mounting bracket
Environmental	
Operating Temperature	with i7-6700TE, i5-6500TE (35W TDP) -25°C ~ 60°C **/** with i7-6700, i5-6500 (65W TDP) -25°C ~ 60°C **/** (configured as 35W CPU mode) -25°C ~ 50°C **/** (configured as 65W CPU mode)
Storage Temperature	-40°C ~85°C
Humidity	10%~90% , non-condensing
Vibration	Operating, 5 Grms, 5-500 Hz, 3 Axes (w/ SSD, according to IEC60068-2-64)
Shock	Operating, 50 Grms, Half-sine 11 ms Duration (w/ SSD, according to IEC60068-2-27)
EMC	CE/FCC Class A, according to EN 55022 & EN 55024 EN 50155:2007

* Maximal power consumption is measured with 100% CPU loading in 65W TDP mode using Passmark® BurnInTest™ v8.0 and 100% GPU loading using TessMark x64 GPU stress test . For detail testing criteria, please contact Neosys Technology.

** The high operating temperature specified here is defined under the condition of 100% GPU loading applied using TessMark x64 GPU stress test. For detail testing criteria, please contact Neosys Technology

*** For sub-zero operating temperature, a wide temperature HDD drive or Solid State Disk (SSD) is required.

1.3 List of Supported CPU

Nuvo-5095GC series supports Intel® 6th-Gen Core™ i7/i5/i3, Pentium and Celeron processor via the LGA1151 CPU socket. You can choose the following processors according to your consideration of cost and performance.

- **Intel® Core™ i7-6700TE Processor (8M Cache, up to 3.40 GHz, 35W TDP)***
- Intel® Core™ i7-6700T Processor (8M Cache, up to 3.60 GHz, 35W TDP)
- **Intel® Core™ i7-6700 Processor (8M Cache, up to 4.00 GHz, 65W TDP)***
- Intel® Core™ i5-6402P Processor (6M Cache, up to 3.40 GHz, 65W TDP)
- **Intel® Core™ i5-6500TE Processor (6M Cache, up to 3.30 GHz, 35W TDP)***
- Intel® Core™ i5-6600 Processor (6M Cache, up to 3.90 GHz, 65W TDP)
- Intel® Core™ i5-6600T Processor (6M Cache, up to 3.50 GHz, 35W TDP)
- **Intel® Core™ i5-6500 Processor (6M Cache, up to 3.60 GHz, 65W TDP)***
- Intel® Core™ i5-6500T Processor (6M Cache, up to 3.10 GHz, 35W TDP)
- Intel® Core™ i5-6400T Processor (6M Cache, up to 2.80 GHz, 35W TDP)
- Intel® Core™ i5-6400 Processor (6M Cache, up to 3.30 GHz, 65W TDP)
- Intel® Core™ i3-6098P Processor (3M Cache, 3.60 GHz, 54W TDP)
- **Intel® Core™ i3-6100TE Processor (4M Cache, 2.70 GHz, 35W TDP)***
- Intel® Core™ i3-6300 Processor (4M Cache, 3.80 GHz, 51W TDP)
- Intel® Core™ i3-6300T Processor (4M Cache, 3.30 GHz, 35W TDP)
- Intel® Core™ i3-6320 Processor (4M Cache, 3.90 GHz, 51W TDP)
- **Intel® Core™ i3-6100 Processor (3M Cache, 3.70 GHz, 51W TDP)***
- Intel® Core™ i3-6100T Processor (3M Cache, 3.20 GHz, 35W TDP)
- **Intel® Pentium® Processor G4400TE (3M Cache, 2.40 GHz, 35W TDP)***
- Intel® Pentium® Processor G4400T (3M Cache, 2.90 GHz, 35W TDP)
- **Intel® Pentium® Processor G4400 (3M Cache, 3.30 GHz, 54W TDP)***
- Intel® Pentium® Processor G4500 (3M Cache, 3.50 GHz, 51W TDP)
- Intel® Pentium® Processor G4500T (3M Cache, 3.00 GHz, 35W TDP)
- Intel® Pentium® Processor G4520 (3M Cache, 3.60 GHz, 51W TDP)
- **Intel® Celeron® Processor G3900TE (2M Cache, 2.30 GHz, 35W TDP)***
- Intel® Celeron® Processor G3920 (2M Cache, 2.90 GHz, 51W TDP)
- **Intel® Celeron® Processor G3900 (2M Cache, 2.80 GHz, 51W TDP)***

*The processors with * are listed in Intel® Embedded Roadmap and with a 7-year life cycle support (2015~2021).*



1.4 List of Supported Graphics Card

Nuvo-5095GC series supports nVidia GTX 950 and 1050 GPU cards with 75W TDP. Additionally, the expansion Cassette and heat dissipation mechanism shall work with selected graphics cards to obtain best thermal stability of GPU. For users who do not purchase graphics card directly from Neosys, please refer to the following list of recommended consumer-grade graphics cards.

GTX 950

- ASUS GeForce® GTX950-M-2GD5

GTX 1050

- GIGABYTE GeForce® GTX 1050 D5 2G

Neosys will keep updating this list as new graphics cards available in the market. Please contact us for the latest GPU card support list.

Chapter 2 Getting to Know your Nuvo-5095GC

2.1 Unpacking your Nuvo-5095GC Controller

When you receive the package of Nuvo-5095GC series, please check immediately if the package contains all the items listed in the following table. If any item is missing or damaged, please contact your local dealer or Neosys Technology Inc. for further assistance.

Item	Description	Qty
1	Nuvo-5095GC fanless controller (According to the configuration you order, CPU/DDR4/HDD/GPU may be included. Please verify these items if necessary.)	1
2	Accessory box, which contains <ul style="list-style-type: none"> ● Neosys Drivers & Utilities DVD ● Wall-mounting bracket ● Foot pad ● 3-pin pluggable terminal block ● HDD thermal pad for 2.5" HDD/SSD (if HDD is not installed) ● Screw pack ● PORON® form strip, 91 x 12 x 2.5 mm (available for barebone only) ● PORON® form strip, 91 x 12 x 10 mm (available for barebone only) ● Rubber spacer (available for barebone only) 	1 2 4 1 1 1 4 4 4

2.2 Front Panel I/O Functions

On Nuvo-5095GC series, plenty of I/O functions are provided on front panel and back panel so you can easily access them. Most common computer I/O functions are placed on the front panel. In this section, we'll illustrate each I/O function on the front panel.

2.2.1 Power Button



The power button is a tact switch for ATX mode on/off operation. To turn on the Nuvo-5095GC controller, press the power button and the PWR LED is lighted up. To turn off the Nuvo-5095GC controller, you can either issue a shutdown command in OS, or just simply press the power button. In case of system halts, you can press and hold the power button for 5 seconds to compulsorily shut down the system. Please note that a 5 seconds interval is kept by the system between two on/off operations (i.e. once turning off the system, you shall wait for 5 seconds to initiate another power-on operation).

2.2.2 Reset Button



The reset button is used to manually reset the system in case of any abnormal condition. To avoid unexpected operation, the reset button is hidden behind the front panel. You need to use a pin-like object to push the reset button.

2.2.3 LED Indicators



There are four LED indicators on the front panel: PWR, HDD, WDT, and IGN. The descriptions of these three LED are listed in the following table.

Indicator	Color	Description
PWR	Green	Power indicator, lighted-up when system is on.
HDD	Red	Hard drive indicator, flashing when SATA hard drive is active.
WDT	Yellow	Watchdog timer indicator, flashing when watchdog timer is started.
IGN	Orange	If ignition option (MezIO-V20) is applied, this LED is used to indicate ignition signal status.

2.2.4 Gigabit Ethernet Port



Nuvo-5095GC series offers 6 GbE ports on its front panel. The GbE port marked in blue is designed with Intel® I219-LM and ports marked in red are implemented with Intel® I210-IT Gigabit Ethernet controllers.

Each port has one dedicated GbE controller and one dedicated PCI Express link to present maximal network performance. When plugging in the Ethernet cable, you can tell the Ethernet status and speed from the LED indicators on the RJ45 connector as following:

Active/Link LED

LED Color	Status	Description
Yellow	Off	Ethernet port is disconnected
	On	Ethernet port is connected and no data transmission
	Flashing	Ethernet port is connected and data is transmitting/receiving

Speed LED

LED Color	Status	Description
Green or Orange	Off	10 Mbps
	Green	100 Mbps
	Orange	1000 Mbps

The port implemented using Intel® I219-LM supports Wake-on-LAN function. It is also capable of operating with Intel® AMT (Active Management Technology) to support advanced features such as remote SOL desktop and remote on/off control. Please refer to section 4.2 for detail.

To utilize the GbE port in Windows, you need to install corresponding driver for Intel® I210-IT/I219-LM GbE controller. Please refer to section 4.5 for information of driver installation.

2.2.5 Remote On/Off Control and Status LED Output



For an application which places Nuvo-5095GC controller inside a cabinet, it's useful to control the on/off of the system via an external switch, as well as check how the system's running via some external LED indicators. Nuvo-5095GC series provides a 2x5, 2.0mm pitch wafer connector on the front panel for this purpose.

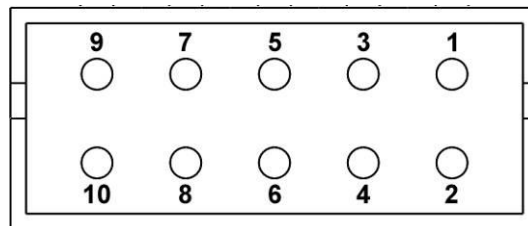

Pin#	Definition	Description
1	Ctrl+	[Input] Remote on/off control, connecting to an external switch to turn on/off the system (polarity is negligible).
2	Ctrl-	
3	Power+	[Output] System power indicator, on if system is turned on, off if system is turned off.
4	Power-	
5	HDD+	[Output] Hard drive indicator, flashing when SATA hard drive is active.
6	HDD-	
7	Standby Power+	[Output] Standby power indicator, lighting up when DC power is applied and system is in S5 (standby) mode.
8	Standby Power-	
9	WDT+	[Output] Watchdog timer indicator, flashing when watchdog timer is started.
10	WDT-	

Note

Please make sure the polarity is correct when you connect the external LED indicator to the Status LED Output.



Pin#3 to pin#10 are used to output the system status including power, HDD, and watchdog timer status. Pin#1 and pin#2 are used to turn on or turn off the system remotely by connecting an external switch. Users should connect a non-latched switch to Ctrl+/Ctrl- as it acts exactly the same as the power button on the front panel. For detail information of using remote on/off control function, please refer to section 3.10.2.

The status LED output has a built-in series-resistor and provides 3.3V, 10mA current, which means you can use these pins to directly drive an external LED indicator.

2.2.6 USB 3.0 Connectors



Nuvo-5095GC series offers four USB 3.0 (SuperSpeed USB) ports on its front panel. They are implemented by native xHCI (eXtensible Host Controller Interface) controller in Q170 chipset and are compatible with USB 3.0, USB 2.0, USB 1.1 and USB 1.0 devices. Legacy USB support is also provided so you can use USB keyboard/mouse in DOS environment. Due to the nature that XHCI driver is not included natively in Windows 7, you may encounter the issue of USB keyboard/mouse not working when installing Windows 7. Neosys offers a Windows-based batch file and step-by-step guide to help you. Please refer to Appendix A for information of installing Windows 7 on Nuvo-5095GC series.

2.2.7 DVI/HDMI Connectors



Nuvo-5095GC series has multiple display outputs on its front panel for connecting different displays according to your system configuration. DVI/HDMI transmits graphics data in digital format and therefore can deliver better image quality at high resolution. The DVI/HDMI connector on the front panel can either output DVI signals or HDMI signal depending on the display device connected. It supports up to 1920 x 1200 resolution. You can use a DVI to HDMI cable to connect a HDMI display device.



Nuvo-5095GC series supports tiple independent display outputs with any combination of VGA, DVI/HDMI and DisplayPort. To support multiple display outputs and achieve best DVI/HDMI output resolution in Windows, you need to install corresponding graphics driver. Please refer to section 4.5 for information of driver installation.

2.2.8 VGA Connector



Nuvo-5095GC series has multiple display outputs on its front panel for connecting different displays according to your system configuration. VGA connector is the most popular way for connecting a display. The VGA output on Nuvo-5095GC series supports up to 1920 x 1200 resolution. By BIOS default and hardware implementation, the VGA output is always enabled even when VGA monitor is not connected.

Nuvo-5095GC series supports tiple independent display outputs with any combination of VGA, DVI/HDMI and DisplayPort. To support multiple display outputs and achieve best DVI/HDMI output resolution in Windows, you need to install corresponding graphics driver. Please refer to section 4.5 for information of driver installation.

Note

1. Please make sure your VGA cable includes SDA and SCL (DDC clock and data) signals for correct communication with monitor to get resolution/timing information. A cable without SDA/SCL can cause blank screen on your VGA monitor due to incorrect resolution/timing output.
2. For customer who connect sole DVI/DP monitor and no VGA output is needed, you can permanently disable VGA output in BIOS menu. In this case, the DVI/DP is set as primary output and display on DVI/DP is available in both DOS and Windows/Linux environment.

2.2.9 DisplayPort



Nuvo-5095GC series has multiple display outputs on its front panel for connecting different displays according to your system configuration. Two DisplayPort (DP) connectors are available for high-resolution graphics outputs. They can deliver 4096 x 2304 resolution when single DP port is used or 2880 x 1800 resolution when both DP ports are simultaneously used. DisplayPort on Nuvo-5095GC series are designed to support passive DP adapter/cable. You can simply use a DP-to-HDMI cable or DP-to-DVI cable connect different display devices.



DP-to-HDMI cable



Passive DP-to-DVI cable

Nuvo-5095GC series supports triple independent display outputs with any combination of VGA, DVI/HDMI and DisplayPort. To support multiple display outputs and achieve best DVI/HDMI output resolution in Windows, you need to install corresponding graphics driver. Please refer to section 4.5 for information of driver installation.

2.3 Back Panel I/O Functions

To fit general application requirements, Nuvo-5095GC series offers more I/O functions on its back panel. In this section, we'll illustrate each I/O function on the back panel.

2.3.1 3-Pin Terminal Block for DC and IGN Input



Nuvo-5095GC series allows a wide range of DC power input from 8 to 35V via a 3-pin pluggable terminal block, which is fit for field usage where DC power is usually provided. And the screw clamping connection of the terminal block gives a very reliable way of wiring DC power. For detail information of supplying DC power via pluggable terminal block, please refer to section 3.9.

In addition to DC power input, this terminal block can also accept ignition signal input (IGN) when MeziO-V20 ignition control module is installed for in-vehicle applications.

Caution

1. Please make sure the voltage of DC power is correct before you connect it to Nuvo-5095GC controller. Supplying a voltage over 35V will damage the system.

2.3.2 COM Ports (COM1 / COM2 / COM3)

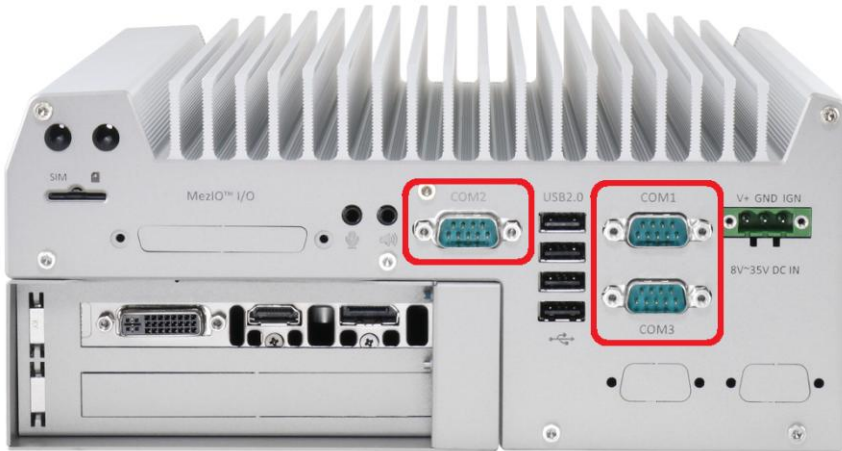

Nuvo-5095GC series provides three COM ports for communicating with external devices. COM1, COM2 and COM3 are located on the back panel via 9-pin D-Sub male connectors. They are implemented using industrial-grade ITE8786 Super IO chip (-40 to 85°C) and provide up to 115200 bps baud rate.

COM1 and COM3 are software-configurable RS-232/422/485 ports and COM2 is a standard 9-wire RS-232 port . The operation mode, slew rate and termination of COM1 and COM3 can be set in BIOS setup utility (refer to section 4.1.1 for detail). The following table describes the pin definition of COM ports.

	COM1 / COM3			COM2
Pin#	RS-232 Mode	RS-422 Mode	RS-485 Mode (Two-wire 485)	RS-232 Mode
1	DCD			DCD
2	RX	422 TXD+	485 TXD+/RXD+	RX
3	TX	422 RXD+		TX
4	DTR	422 RXD-		DTR
5	GND	GND	GND	GND
6	DSR			DSR
7	RTS			RTS
8	CTS	422 TXD-	485 TXD-/RXD-	CTS
9	RI			RI

2.3.3 USB2.0 Connectors

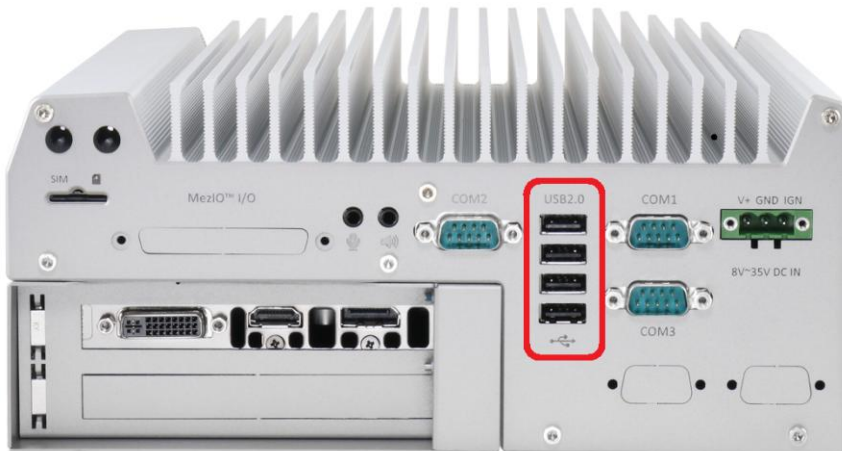

In addition to USB 3.0, Nuvo-5095GC Series provides four USB 2.0 ports on the back panel. They are implemented by native xHCI (eXtensible Host Controller Interface) controller in Q170 chipset and are compatible with USB 2.0, USB 1.1 and USB 1.0 devices. Legacy USB support is also provided so you can use USB keyboard/mouse in DOS environment. Due to the nature that XHCI driver is not natively included in Windows 7, you may encounter the issue of USB keyboard/mouse not working when installing Windows 7. Neosys offers a Windows-based batch file and step-by-step guide to help you. Please refer to Appendix A for information of installing Windows 7 on Nuvo-5095GC series.

2.3.4 Speaker-out and Mic-in Audio Jacks



Nuvo-5095GC series provides audio function using Intel® High Definition Audio in Q170 chipset and Realtek ALC262 codec. There are two audio jacks on the back panel. The left one is used for microphone input, and the right one is used for speaker output. To utilize the audio function in Windows, you need to install corresponding drivers for both Intel® Q170 chipset and Realtek ALC262 codec. Please refer to section 4.5 for information of driver installation.

2.3.5 MezIO™ I/O Connector

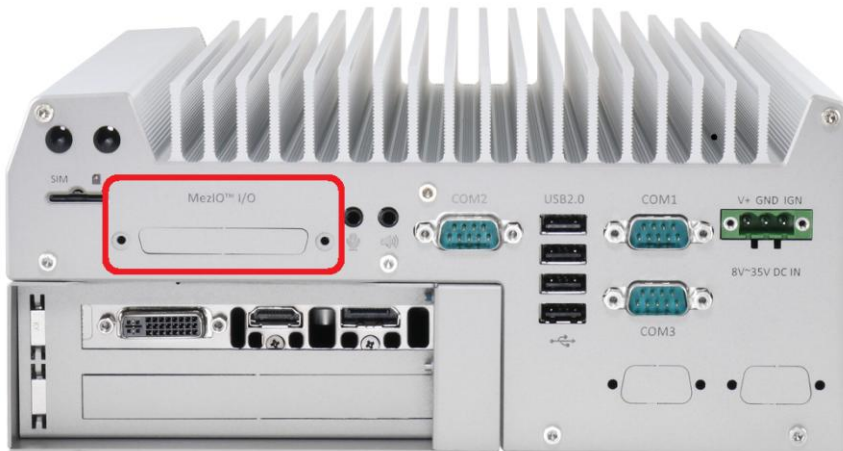

Nuvo-5095GC series incorporates Neusys' MezIO™ interface. You can install a MezIO™ module to expand application-oriented I/O function. To support MezIO™ I/O connectivity, Nuvo-5095GC series reserves the cutting hole for a SCSI-II 68-pin connector on its back panel. Please refer to section 2.5 for information of MezIO™ interface and section 3.6 for installing a MezIO™ module.

2.3.6 SIM Socket



Nuvo-5095GC series provides a panel-accessible SIM socket is on the back panel. Combining with a 3G/4G module installed on internal mini-PCIe port, you can have Internet access via telecom operator's network. The SIM socket is a push-push type. You can insert and push a SIM card to the end to install it, and push the installed SIM card again to eject it. Please note that SIM card must be inserted upside down. You can refer to section 3.5 for information of installing a 3G/4G module and SIM card.

2.4 Internal I/O Functions

In addition to I/O connectors on the front/back panel, Nuvo-5095GC series provides other features via its on-board connectors, such as SATA ports, mini-PCIe sockets, internal USB ports and MezIO™ interface. In this section, we'll illustrate these internal I/O functions.

2.4.1 DDR4 SODIMM Sockets

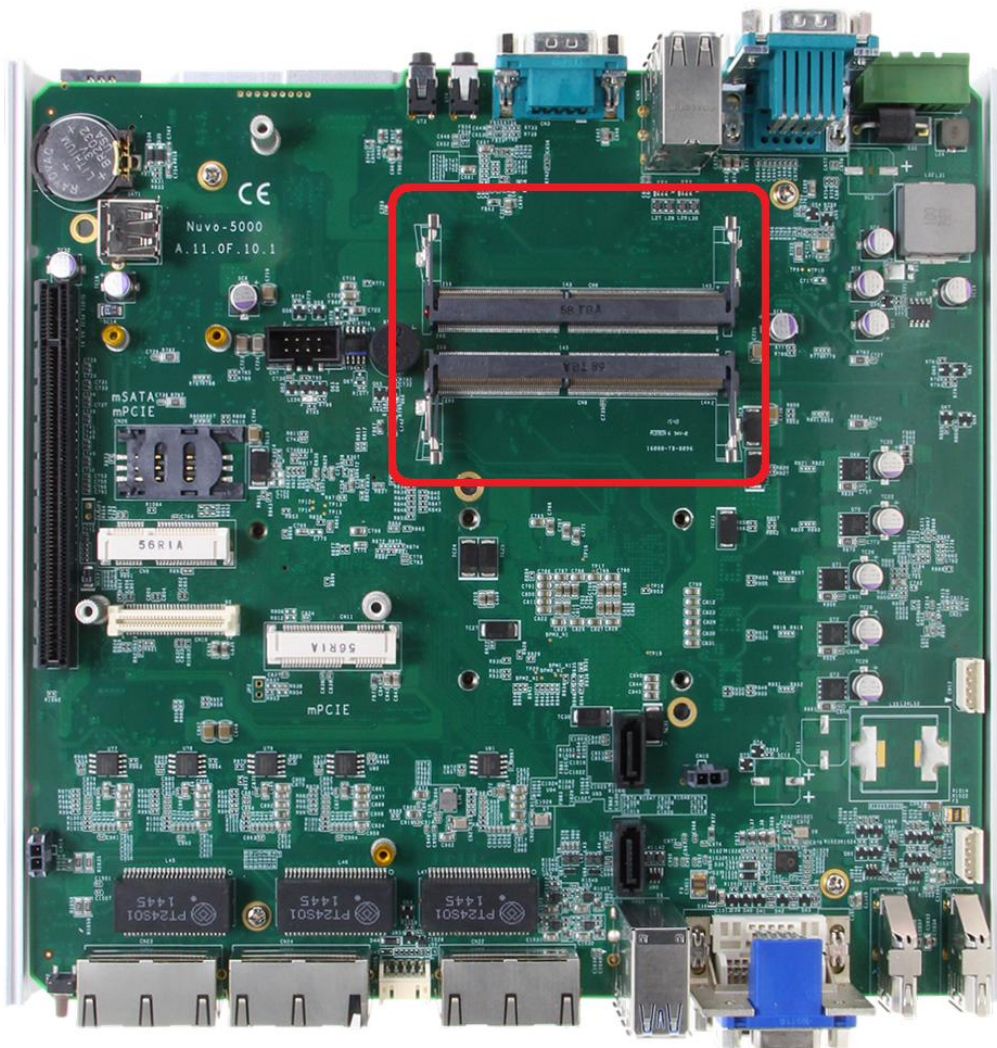

Nuvo-5095GC series provides two 260-pin, SODIMM sockets for installing DDR4 memory modules. It supports maximal 32GB capacity by installing two 16GB DDR4 2133 MHz SODIMM modules. For information of installing DDR4 memory modules, please refer to section 3.3 for details.

2.4.2 mSATA / mini-PCle #1 Dual-Mode Socket

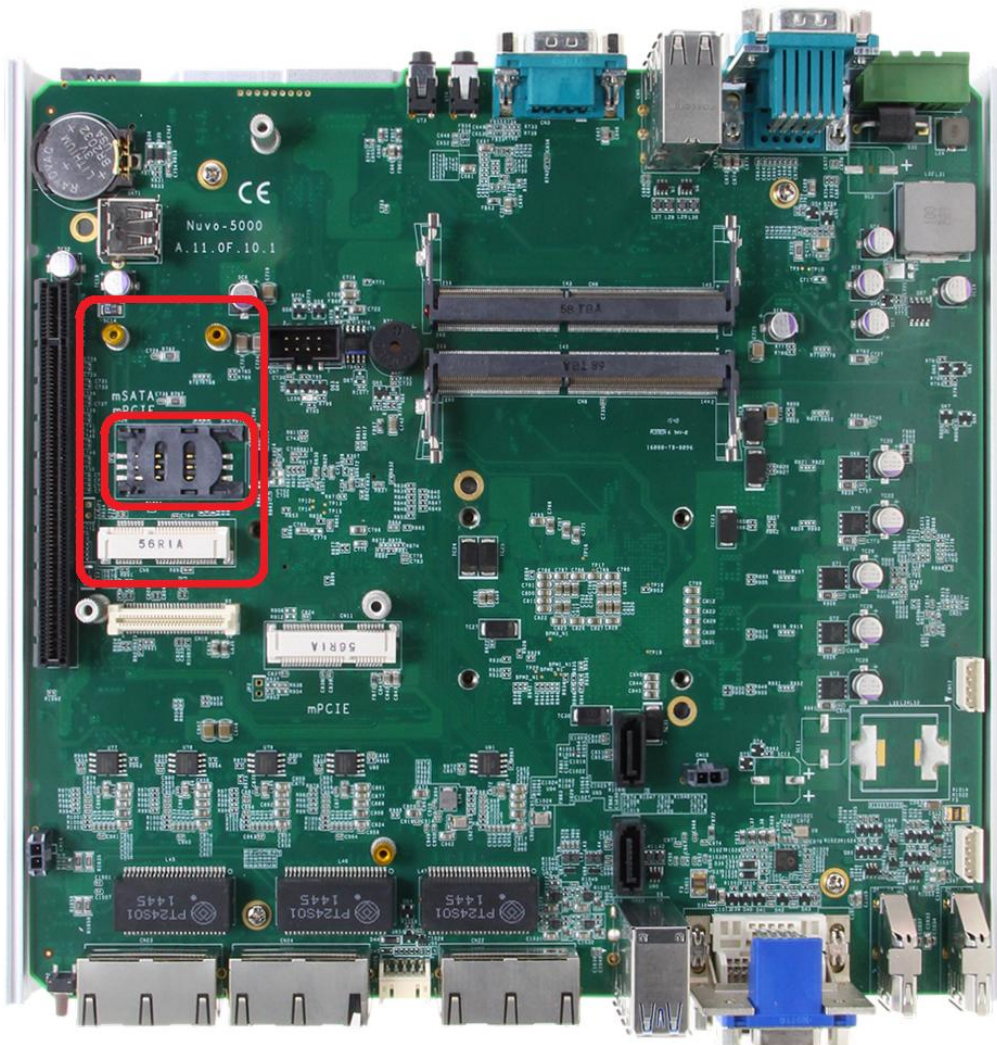

Nuvo-5095GC series provides two mini-PCle sockets compliant with mini-PCle specification rev. 1.2. The first socket supports mini-PCle and mSATA dual mode operation. You can install either a mSATA SSD or mini-PCle module into this socket. The system automatically detects and configures it to run PCIe or SATA signals according to installed module. This mini-PCle socket is designed with SIM card support. With a SIM card installed, it's capable to connect your system to Internet in wide territory through telecom 3G/4G network.

For WIFI/3G/4G communication, Nuvo-5095GC series provides multiple SMA antenna apertures on the front and back panel for multi-antenna configuration.



The following table describes the pin definition of mSATA/mini-PCIe #1 dual-mode socket.

Pin #	Signal (mPCIe)	Signal (mSATA)	Pin #	Signal (mPCIe)	Signal (mSATA)
1	WAKE#	-	2	+3.3Vaux	+3.3Vaux
3	COEX1	-	4	GND	GND
5	COEX2	-	6	+1.5V	+1.5V
7	CLKREQ#	-	8	UIM_PWR	-
9	GND	GND	10	UIM_DATA	-
11	REFCLK-	-	12	UIM_CLK	-
13	REFCLK+	-	14	UIM_RESET	-
15	GND	GND	16	UIM_VPP	-
Mechanical Key					
17	Reserved* (UIM_C8)	-	18	GND	GND
19	Reserved* (UIM_C4)	-	20	W_DISABLE#	-
21	GND	GND	22	PERST#	-
23	PERn0	SATA_Rxp	24	+3.3Vaux	+3.3Vaux
25	PERp0	SATA_Rxn	26	GND	GND
27	GND	GND	28	+1.5V	+1.5V
29	GND	GND	30	SMB_CLK	SMB_CLK
31	PETn0	SATA_Txn	32	SMB_DATA	SMB_DATA
33	PETp0	SATA_Txp	34	GND	GND
35	GND	GND	36	USB_D-	-
37	GND	GND	38	USB_D+	-
39	+3.3Vaux	+3.3Vaux	40	GND	GND
41	+3.3Vaux	+3.3Vaux	42	LED_WWAN#	-
43	GND	-	44	LED_WLAN#	-
45	Reserved	-	46	LED_WPAN#	-
47	Reserved	-	48	+1.5V	+1.5V
49	Reserved	-	50	GND	GND
51	Reserved	-	52	+3.3Vaux	+3.3Vaux

Note

Some off-the-shelf mini-PCle 4G modules are not compliant to standard mini-PCle interface. They use 1.8V I/O signals instead of standard 3.3V I/O, and may have signal conflict on certain pins. Please make sure your 4G module has the correct pin definition or consult Neosys for the compatibility. Installing an incompatible 4G module may damage the system or the module itself may be damaged.

2.4.3 Mini-PCle #2 Socket

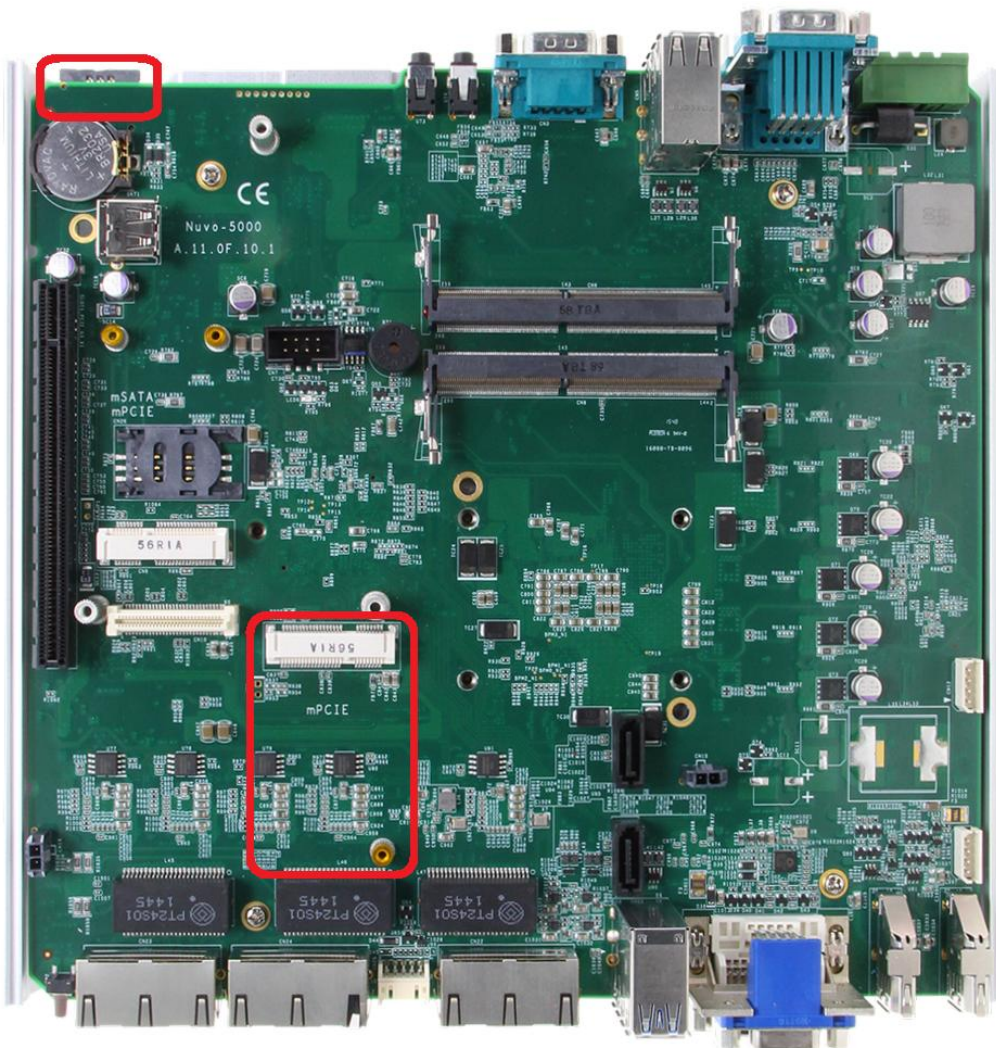

Nuvo-5095GC series provides two mini-PCle sockets compliant with mini-PCle specification rev. 1.2. The second mini-PCle socket works with the panel-accessible SIM slot. There are plenty of off-the-shelf mini-PCle modules with versatile capabilities. By installing a mini-PCle module, your system can have expanded features such as WIFI, GPS, CAN bus, analog frame grabber and etc. You can also install a 3G/4G module and SIM card to access Internet in wide territory through telecom 3G/4G network. For WIFI/3G/4G communication, Nuvo-5095GC provides multiple SMA antenna apertures on the front and back panel for multi-antenna configuration.



The following table describes the pin definition of mini-PCIe #2 socket.

Pin #	Signal	Pin #	Signal
1	WAKE#	2	+3.3Vaux
3	COEX1	4	GND
5	COEX2	6	+1.5V
7	CLKREQ#	8	UIM_PWR
9	GND	10	UIM_DATA
11	REFCLK-	12	UIM_CLK
13	REFCLK+	14	UIM_RESET
15	GND	16	UIM_VPP
Mechanical Key			
17	Reserved* (UIM_C8)	18	GND
19	Reserved* (UIM_C4)	20	W_DISABLE#
21	GND	22	PERST#
23	PERn0	24	+3.3Vaux
25	PERp0	26	GND
27	GND	28	+1.5V
29	GND	30	SMB_CLK
31	PETn0	32	SMB_DATA
33	PETp0	34	GND
35	GND	36	USB_D-
37	GND	38	USB_D+
39	+3.3Vaux	40	GND
41	+3.3Vaux	42	LED_WWAN#
43	GND	44	LED_WLAN#
45	Reserved	46	LED_WPAN#
47	Reserved	48	+1.5V
49	Reserved	50	GND
51	Reserved	52	+3.3Vaux

Note

Some off-the-shelf mini-PCIe 4G modules are not compliant to standard mini-PCIe interface. They use 1.8V I/O signals instead of standard 3.3V I/O, and may have signal conflict on certain pins. Please make sure your 4G module has the correct pin definition or consult Neosys for the compatibility. Installing an incompatible 4G module may damage the system or the module itself may be damaged.

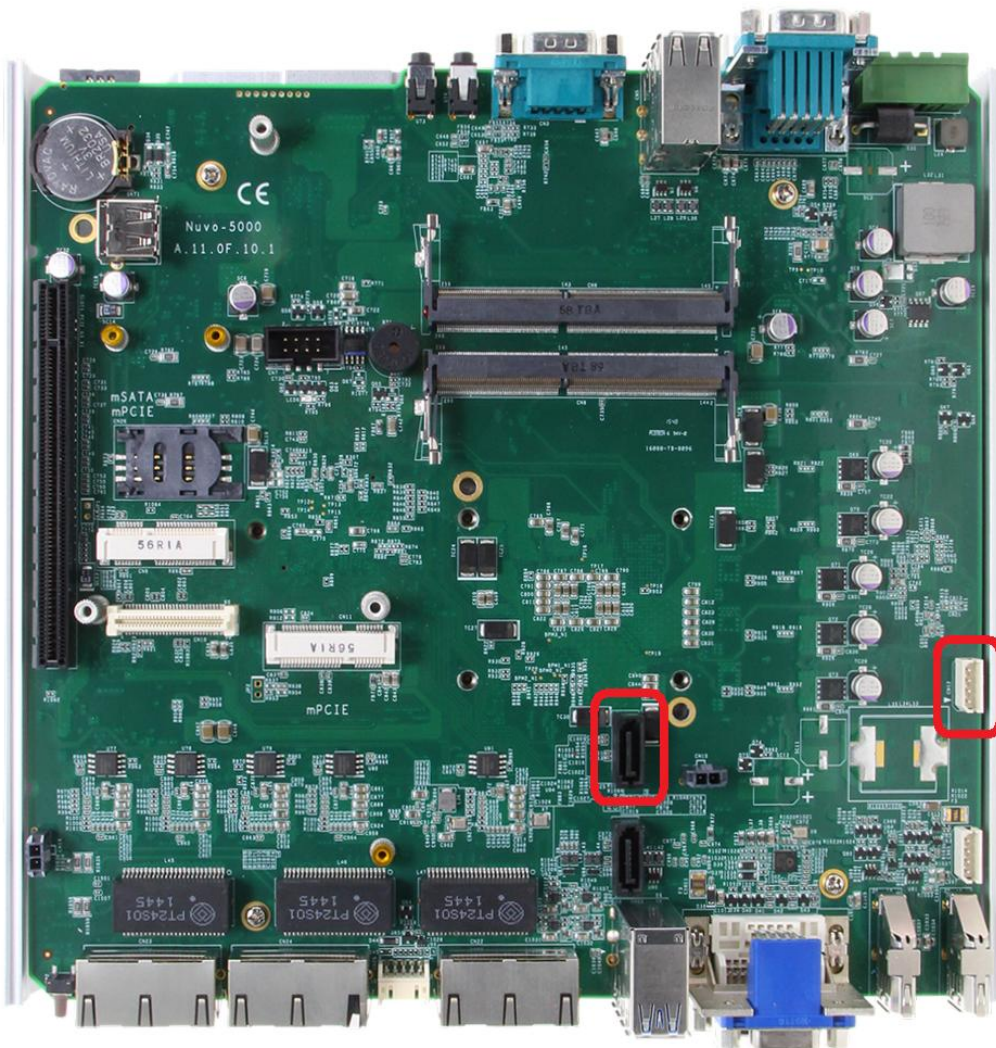
2.4.4 Internal SATA Port #1

Nuvo-5095GC series provides two SATA ports which support Gen3, 6 Gb/s SATA signals. Each SATA port is composed of a 7-pin SATA connector and a 4-pin power connector. SATA port #1 is used in conjunction with the HDD bracket to accommodate the first 2.5" HDD/SSD. A dedicated cable is shipped with the system to provide standard 22-pin SATA connector. For information of installing a HDD/SSD to SATA port #1, please refer to section 3.4 for detail.

2.4.5 Internal SATA Port #2

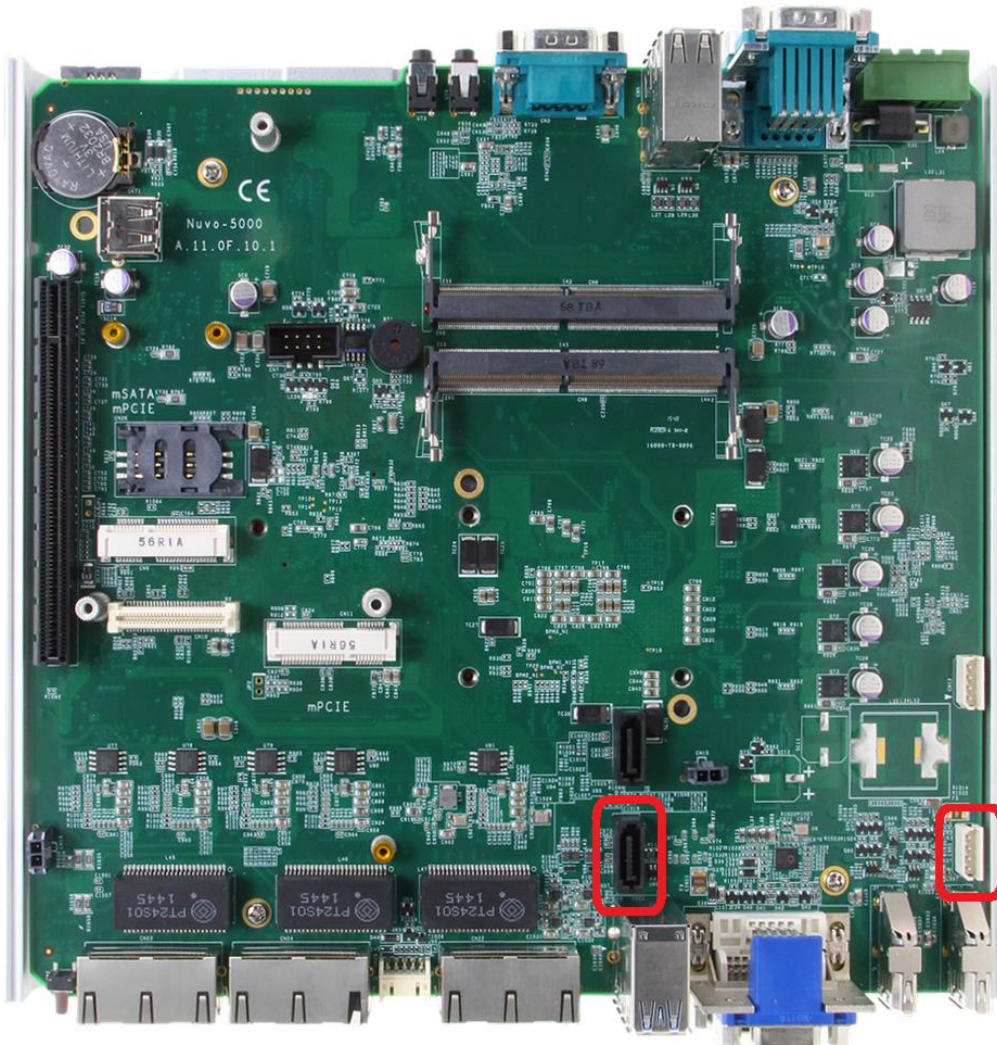

Nuvo-5095GC series provides two SATA ports which support Gen3, 6 Gb/s SATA signals. Each SATA port is composed of a 7-pin SATA connector and a 4-pin power connector. SATA port #2 is used in conjunction with the HDD bracket to accommodate the second 2.5" HDD/SSD. A dedicated cable is shipped with the system to provide standard 22-pin SATA connector. For information of installing a HDD/SSD to SATA port #2, please refer to section 3.4 for detail.

2.4.6 Internal USB Port

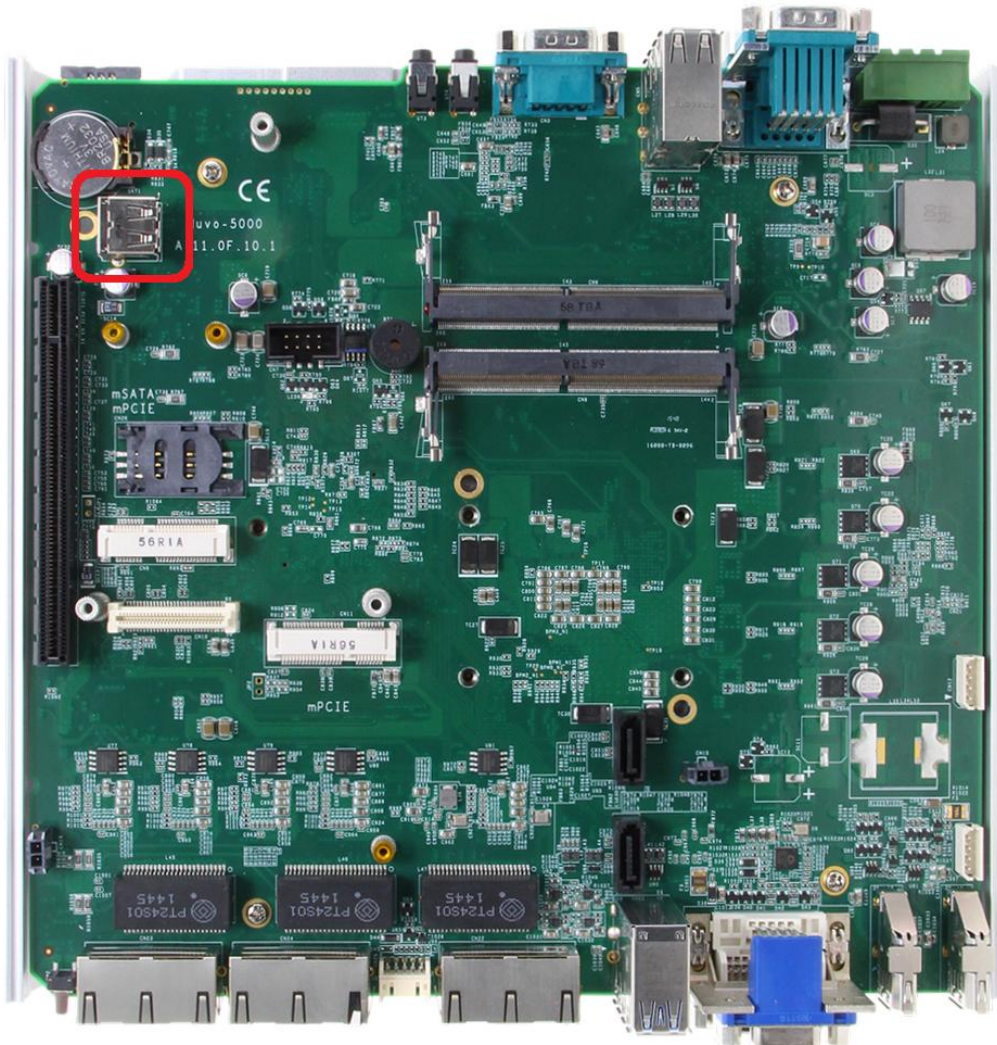

Nuvo-5095GC series provides one additional USB port internally on the PCBA. It supports standard USB 2.0 signals. You can utilize this USB port to connect a USB protection dongle inside the chassis of Nuvo-5095GC controller.

2.5 MezIO™ Interface

MezIO™ is an innovative interface designed for integrating application-oriented I/O functions into an embedded system. It offers computer signals, power rails and control signals via a high-speed connector. MezIO™ is also mechanically reliable benefited from its 3-point mounted mezzanine structure. A MezIO™ module can leverage these signals to implement comprehensive I/O functions.

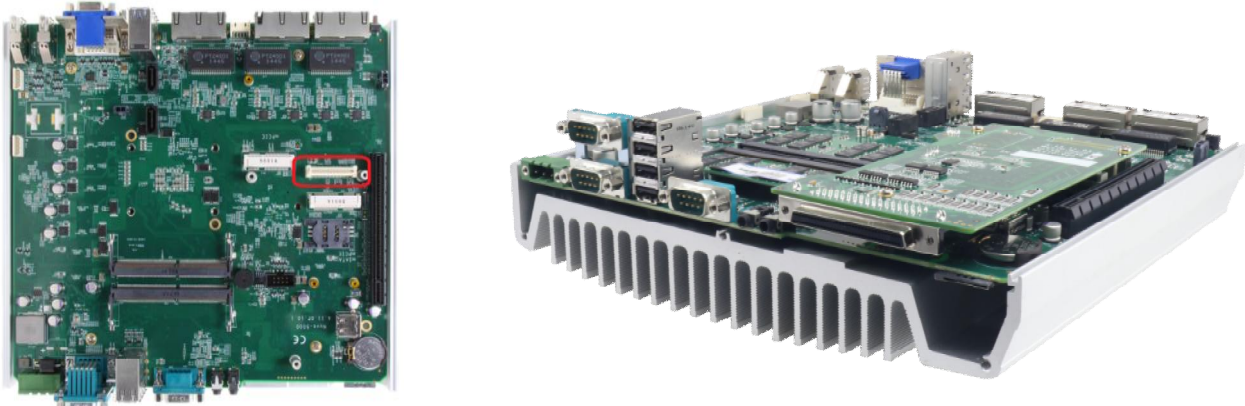

Nuvo-5095GC series incorporates MezIO™ interface and universal mechanical design to accommodate Neusys' standard MezIO™ modules. For customers who want to develop their own MezIO™ module, Neusys provides MezIO™ design documents on a NDA basis. Please contact Neusys for further information.

2.5.1 Pin Definition of MezIO™ Interface

MezIO™ interface leverages FCI BERGSTAK® board-to-board connector to provide interconnectivity of high-speed signals. The receptacle part on the PCBA is FCI 61082-063402LF while the plug part on the MezIO™ module is FCI 61083-064402LF. Please refer to the following table for signal definition of its 60-pos connector.



Function Description	Signal	Pin #	Pin #	Signal	Function Description
Reserved	Reserved	1	2	PCIE_TXP_0	PCle data pair
Reserved	Reserved	3	4	PCIE_TXN_0	PCle data pair
Reserved	Reserved	5	6	GND	Ground
Reserved	Reserved	7	8	PCIE_RXP_0	PCle data pair
System S4 signal	SLP_S4#	9	10	PCIE_RXN_0	PCle data pair
Ground	GND	11	12	CLK100_P_0	PCle clock pair
Reserved	Reserved	13	14	CLK100_N_0	PCle clock pair
Ground	GND	15	16	GND	Ground
Reserved	UID_LED	17	18	PCIE_TXP_1	PCle data pair
Platform reset signal	PLT_RST#	19	20	PCIE_TXN_1	PCle data pair
USB data pair	USBP5_N	21	22	PCIE_RXP_1	PCle data pair
USB data pair	USBP5_P	23	24	PCIE_RXN_1	PCle data pair
Ground	GND	25	26	GND	Ground
SMB bus	SMB_DATA	27	28	CLK100_P_1	PCle clock pair
SMB bus	SMB_CLK	29	30	CLK100_N_1	PCle clock pair
PCle data pair	PCIE_TXP_3	31	32	GND	Ground
PCle data pair	PCIE_TXN_3	33	34	PCIE_TXP_2	PCle data pair
Ground	GND	35	36	PCIE_TXN_2	PCle data pair
PCle data pair	PCIE_RXP_3	37	38	GND	Ground
PCle data pair	PCIE_RXN_3	39	40	PCIE_RXP_2	PCle data pair
Power button signal	PWRBTN#	41	42	PCIE_RXN_2	PCle data pair
Reserved	Reserved	43	44	RXD4	SIO COM4
PCH GPIO	GPIO_RISER3	45	46	TXD4	SIO COM4
PCH GPIO	GPIO_RISER2	47	48	RXD5	SIO COM5
PCH GPIO	GPIO_RISER1	49	50	TXD5	SIO COM5
Ground	GND	51	52	GND	Ground
3.3V power	P3V3	53	54	P1V8	1.8V power
3.3V power	P3V3	55	56	GND	Ground
5V power	P5V	57	58	P12V	12V power
5V power	P5V	59	60	P12V	12V power

2.5.2 MezIO™ Module for Nuvo-5095GC Series

Neosys offers standard MezIO™ modules to expand I/O functions for Nuvo-5095GC series. Currently you can have more RS-232/422/485 ports, isolated digital I/O or ignition power control by installing the following module into your Nuvo-5095GC controller. Neosys will continuously develop MezIO™ modules with versatile features for Nuvo-5095GC series and other embedded products.

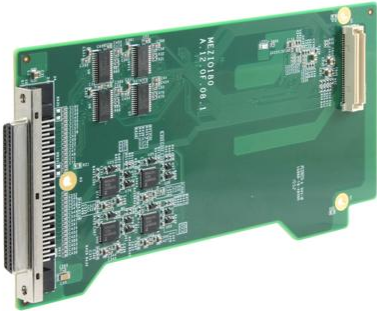
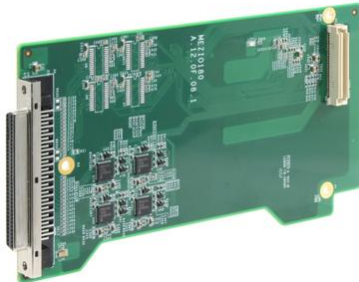
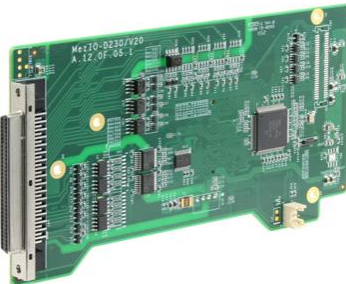
Model	Description	Product Photo
MezIO-C180-50	4-port RS-232/422/485 and 4-port RS-232 MezIO™ module	
MezIO-C181-50	4-port RS-232/422/485 and 4-port RS-422/485 MezIO™ module	
MezIO-D220-50	8-CH isolated DI and 8-CH isolated DO MezIO™ module	

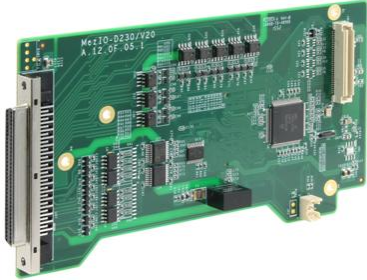
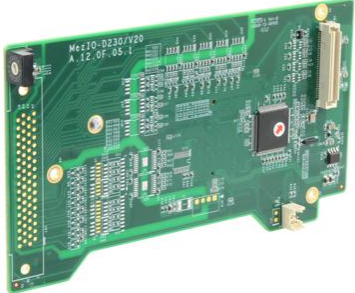
<p>MezIO-D230-50</p>	<p>16-CH isolated DI and 16-CH isolated DO MezIO™ module</p>	 <p>The image shows a green printed circuit board (PCB) for the MezIO-D230-50 module. It features a large multi-pin connector on the left side, a smaller connector on the right, and various electronic components including integrated circuits, resistors, and capacitors. The PCB is populated with components and has a clean, professional appearance.</p>
<p>MezIO-V20</p>	<p>16-mode ignition power control MezIO™ module (Nuvo-5095GCLP only)</p>	 <p>The image shows a green printed circuit board (PCB) for the MezIO-V20 module. It features a large multi-pin connector on the left side, a smaller connector on the right, and various electronic components including integrated circuits, resistors, and capacitors. The PCB is populated with components and has a clean, professional appearance.</p>

2.6 Expansion Cassette for GPU

Neosys' patented expansion Cassette (R.O.C. Patent No. M456527) is an innovation design for fanless controller. By providing a separated compartment to accommodate add-on card, it's more effective to manage the thermal conditions of both the system and the add-on card. The modular concept brought by Cassette also reduces the complexity of installing and replacing an add-on card in the fanless controller.

Based on this patented Cassette, Nuvo-5095GC series further incorporates an innovative mechanical design to effectively deal with the heat generated by GPU. This patented architecture (R.O.C. Patent No. M534371) creates a sealed tunnel to bring cold air to the GPU and exhaust hot air by system fan, and makes Nuvo-5095GC extremely reliable when operating at at 60°C with 100% GPU loading.



The expansion Cassette of Nuvo-5095GC series accepts graphics cards of dual-slot width with up to 75W TDP. Currently nVidia GTX 950 and GTX 1050 are the recommended GPU models for Nuvo-5095GC series. For information of selecting and installing nVidia GTX 950/1050, please refer to section 3.7.



2.6.1 Inside the Cassette of Nuvo-5095GC

The expansion Cassette of Nuvo-5095GC series contains a backplane with a x16 PCI Express connector. It runs 8-lanes, Gen3 PCIe signals to provide a maximal 8 GB/s bandwidth. It supports up to 7A@12V rated current (84 watts) for a PCIe graphics card. Currently 75W nVidia GTX 950 and GTX 1050 are the most powerful GPU available for the expansion Cassette of Nuvo-5095GC. 12V power is directly delivered via PCIe connector so no additional power cable is needed between backplane and GPU.



#	Connector	Function Description										
1	x16 PCI Express	x16 PCI Express connector that runs 8-lane, Gen3 signals. Compatible with x16, x8, x4 and x1 PCI Express add-on card.										
2	12VDC Fan Power	<p>3-pin, 2.54mm pitch power connector for supplying 12VDC to the optional fan. By default, the fan is installed and connected to the fan power connector.</p> <div style="text-align: center;">  </div> <table border="1" style="margin-left: auto; margin-right: auto;"> <thead> <tr> <th>Pin</th> <th>Description</th> </tr> </thead> <tbody> <tr> <td>1</td> <td>N/A</td> </tr> <tr> <td>2</td> <td>12V (2A rated Current)</td> </tr> <tr> <td>3</td> <td>GND</td> </tr> </tbody> </table>	Pin	Description	1	N/A	2	12V (2A rated Current)	3	GND		
Pin	Description											
1	N/A											
2	12V (2A rated Current)											
3	GND											
3	5/12VDC Power	<p>4-pin, 2.0mm pitch wafer connector for supplying 5/12VDC</p> <div style="text-align: center;">  </div> <table border="1" style="margin-left: auto; margin-right: auto;"> <thead> <tr> <th>Pin</th> <th>Description</th> </tr> </thead> <tbody> <tr> <td>1</td> <td>12V (2A rated Current)</td> </tr> <tr> <td>2</td> <td>GND</td> </tr> <tr> <td>3</td> <td>GND</td> </tr> <tr> <td>4</td> <td>5V (2A rated Current)</td> </tr> </tbody> </table>	Pin	Description	1	12V (2A rated Current)	2	GND	3	GND	4	5V (2A rated Current)
Pin	Description											
1	12V (2A rated Current)											
2	GND											
3	GND											
4	5V (2A rated Current)											

2.7 Mechanical Dimension

2.7.1 Top View of Nuvo-5095GC Series

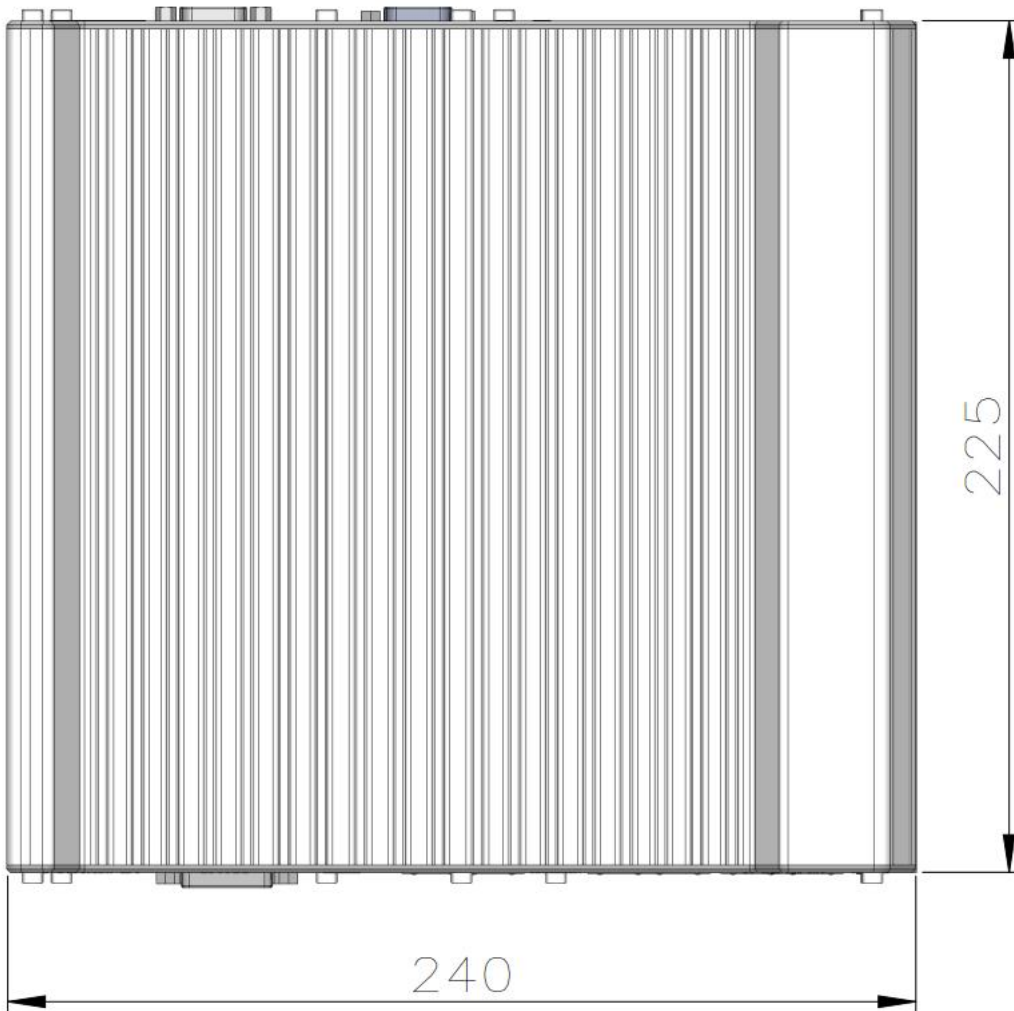

2.7.2 Front View of Nuvo-5095GC Series

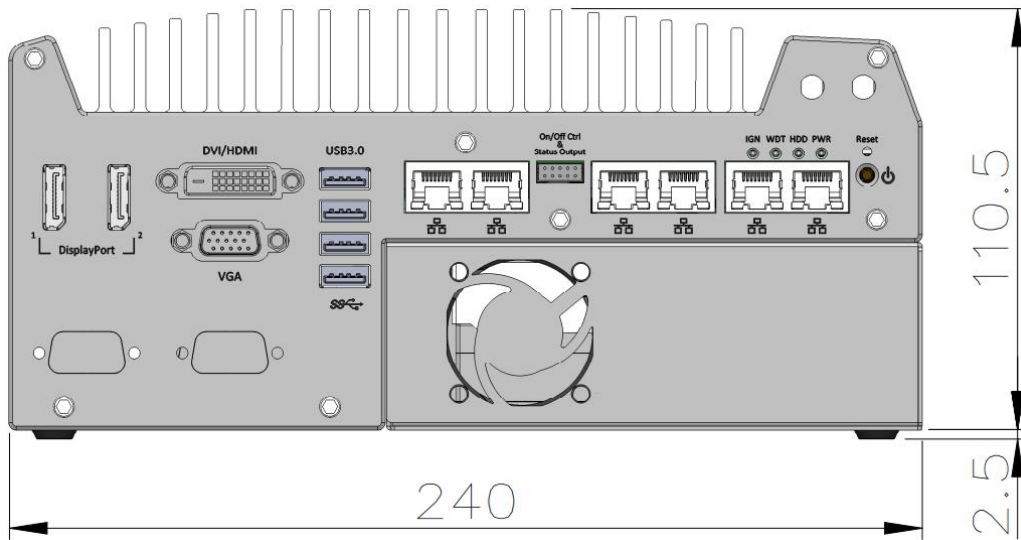

2.7.3 Side View of Nuvo-5095GC Series



2.7.4 Bottom View of Nuvo-5095GC Series

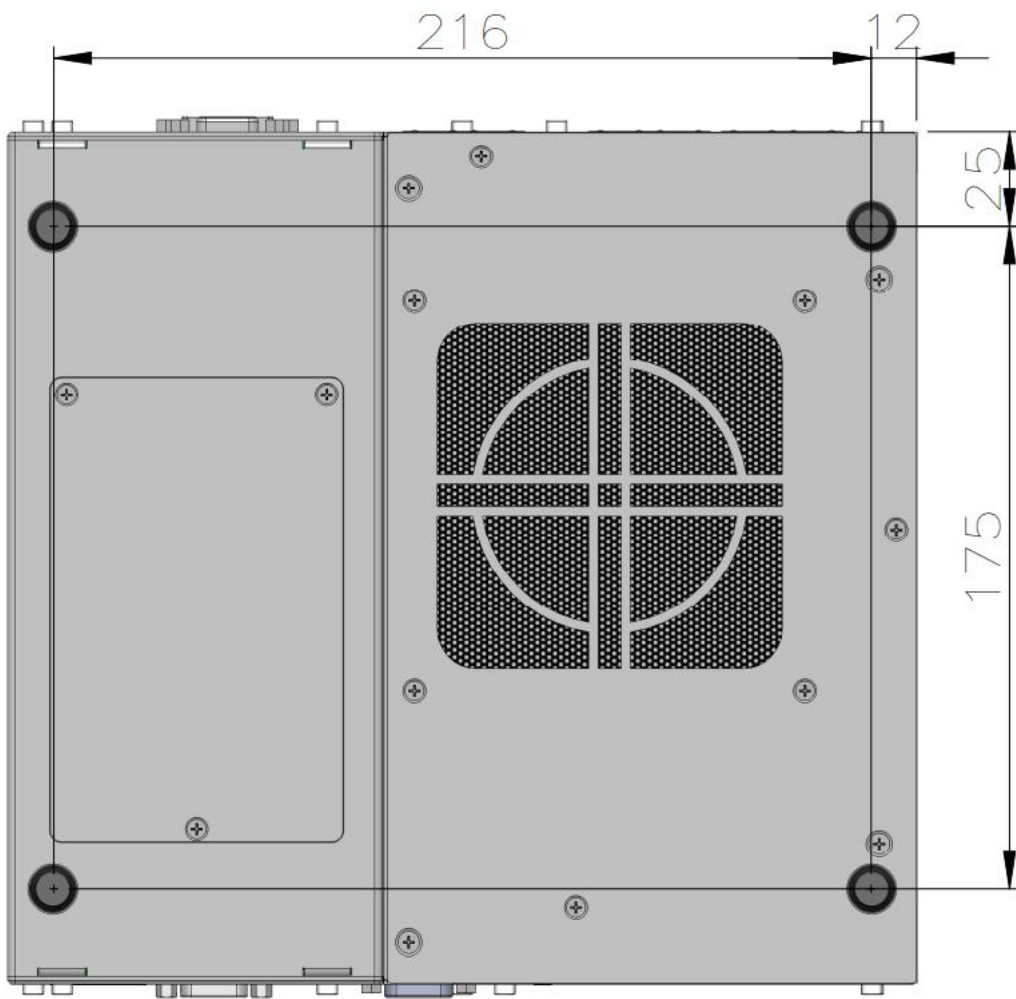

Chapter 3 Getting Start

In this chapter, we'll illustrate how to disassemble your Nuvo-5095GC controller and install all necessary components such as CPU, memory and hard drive. Please exactly follow the procedures to prevent any damage on your Nuvo-5095GC controller.

3.1 Disassemble your Nuvo-5095GC Controller

In prior to install components such as CPU, memory and HDD to Nuvo-5095GC series, you need to disassemble Nuvo-5095GC controller and expose the PCBA. Please cautiously follow the procedures described here to prevent any damage on your Nuvo-5095GC controller.

1. Put the Nuvo-5095GC controller upside down on a flat surface.
2. Unscrew four M3 flat-head screws and detach Cassette by pulling it up.



3. Unscrew seven hex bolts on the front panel and another seven hex bolts on the back panel. And remove both front panel and back panel.



(another 7 hex bolts on the opposite side)

4. Remove the bottom cover of Nuvo-5095GC controller. You can see the PCBA exposed.

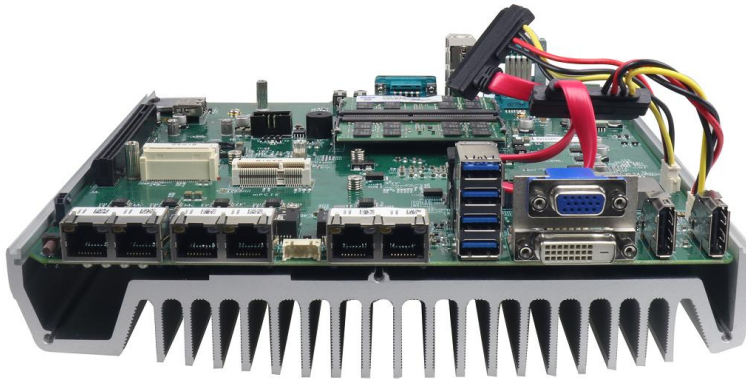

3.2 Install and Replace LGA1151 CPU

Nuvo-5095GC series supports 6th-Gen, LGA1151 socket-type CPU. You can select the CPU according to your consideration of performance, cost and ambient condition. This section describes how to install or replace the CPU on your Nuvo-5095GC controller.

Caution

Please carefully handle the exposed LGA socket on PCBA. The contacts of LGA1151 socket without protective cover are extremely easy to be damaged by foreign objects. You shall always put the protective cover back to the LGA socket when CPU is absent.

3.2.1 Install a CPU on Nuvo-5095GC

For a Nuvo-5095GC series barebone (without CPU installed), please follow steps described below to install a CPU on it.

1. Follow steps described in section 3.1 to disassemble the Nuvo-5095GC controller.
2. Remove the PCBA from the heat-sink by loosening four M3 P-head (red circles).

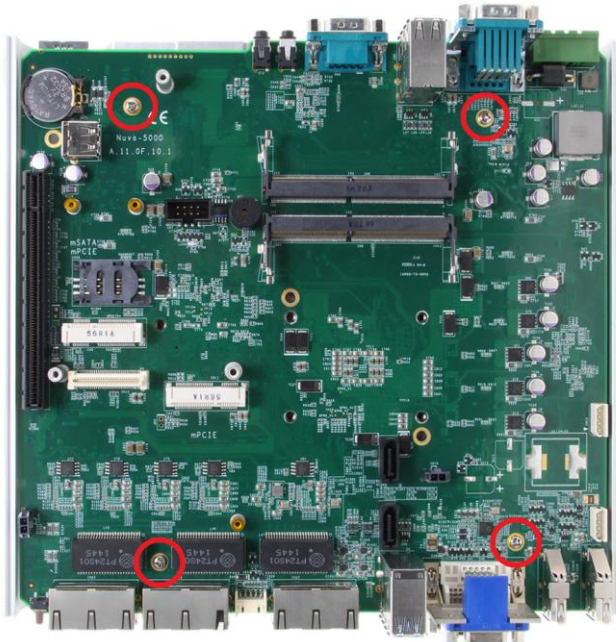

- Place the PCBA on a flat surface. Remove the plastic protective cover from the LGA1151 socket.

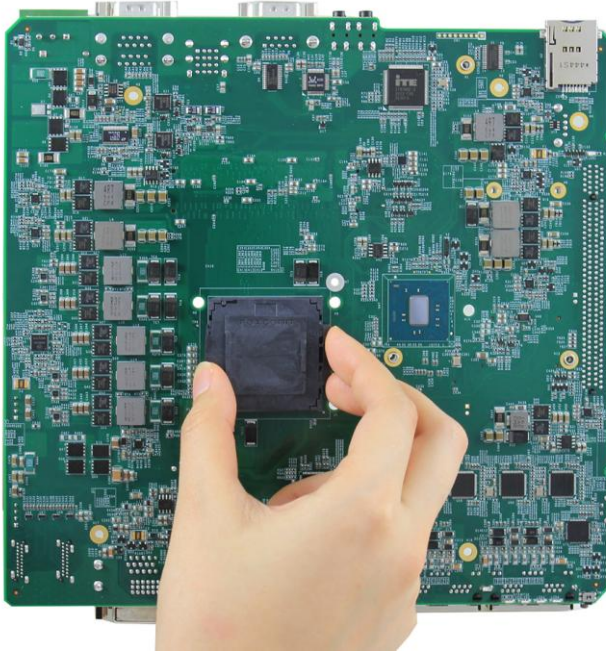

Caution

When the protective cover is removed and LGA1151 socket is exposed, please carefully handle the PCBA to avoid any damage on LGA socket.

- Make sure that you line up the two guiding notches on the LGA1151 socket with the notches along the edges of the CPU. Place the CPU into the socket and by holding it firmly by the sides and lowering it into the socket.

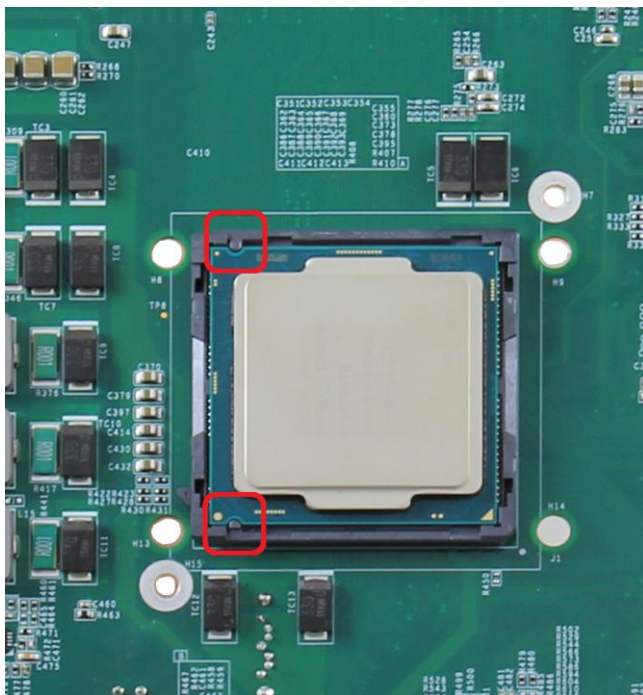

5. Get the CPU retaining bracket from the accessory box and place it on the top of CPU. The CPU retaining bracket shall be screwed from the opposite side. Please hold the CPU and bracket firmly while turning the PCBA upside down, and secure the CPU retaining bracket with two M3 P-head screws.

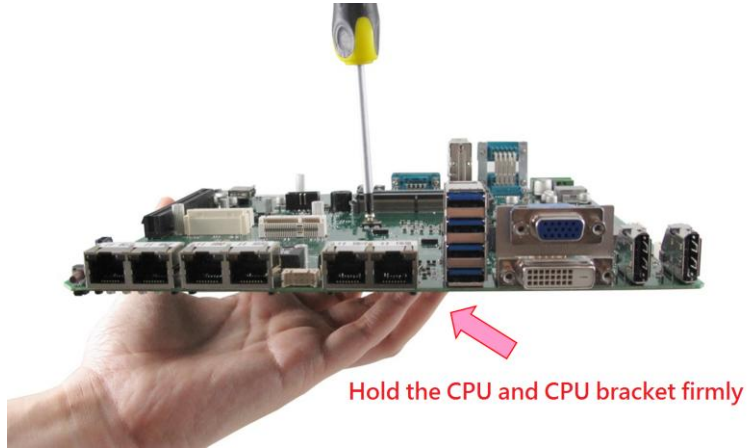

6. Remove all protective films of thermal pads of the heat-sink.

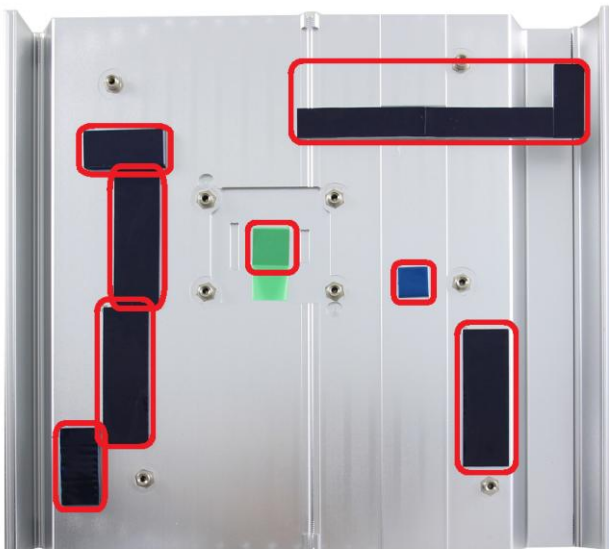

- Put the PCBA back to heat-sink. Make sure all the screw holes on PCBA are aligned with mounting posts of the heat-sink.

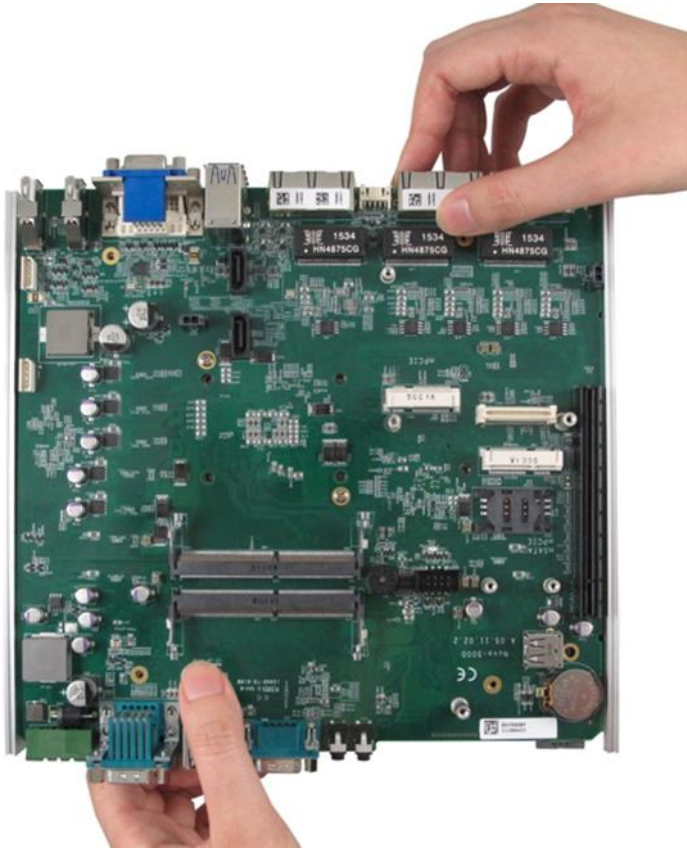

- Get five M3 spring screws from the accessory box. Fix them according to the order indicated on the photo (red circles). And tighten four M3 P-head screws (yellow circles) to fix the PCBA to the heat-sink.

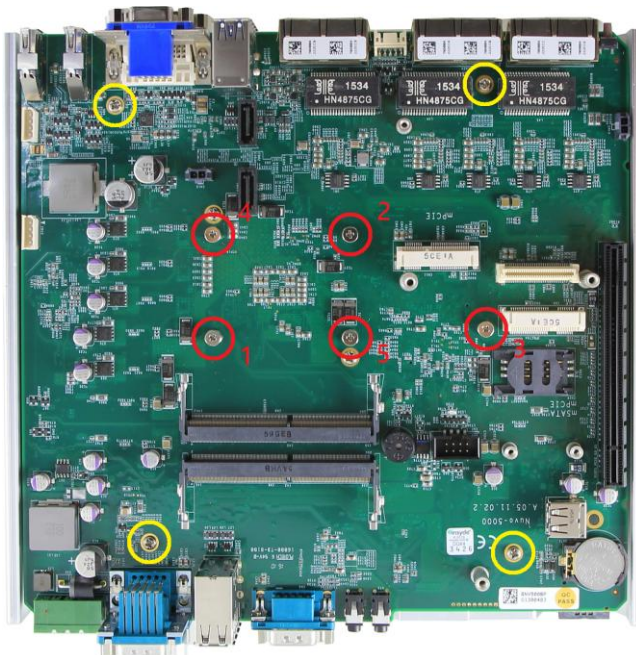

3.2.2 Replace the CPU on Nuvo-5095GC

For a Nuvo-5095GC system with CPU installed, please follow steps described below to replace the CPU on it.

Caution

1. Please make sure the PCBA/heat-sink assembly is cooled down to room temperature before you proceed with the installation/replacement procedures. Replacing the CPU at high temperature may damage the system.
 2. Please carefully handle the exposed LGA socket on PCBA. The contacts of LGA1151 socket without protective cover are extremely easy to be damaged by foreign objects. You shall always put the protective cover back to the LGA socket when CPU is absent.
1. Follow steps described in section 3.1 to disassemble the Nuvo-5095GC controller.
 2. Remove the PCBA from the heat-sink by loosening five M3 spring screws (red circles) and six M3 P-head (yellow circles).

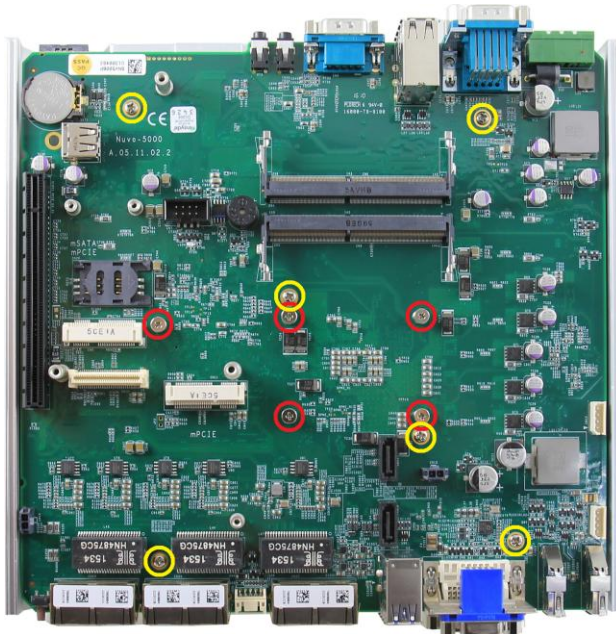

3. Gently lift the PCBA from the heat-sink. The CPU and CPU retaining bracket shall stay with the heat-sink.

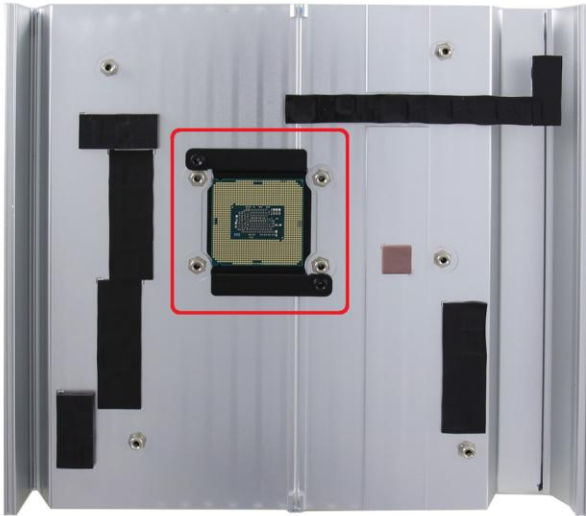
**Caution**

When the PCBA is detached and LGA1151 socket is exposed, please carefully handle the PCBA to avoid any damage on LGA socket.

4. Insert a slotted screwdriver into the gap between the CPU retaining bracket and the heat-sink, and lever the CPU and bracket. Please DO NOT apply force to the CPU otherwise the CPU can be damaged.



5. Check the condition of thermal pads on the heat-sink, especially the thermal pad for CPU. If it's broken, please replace it with a new one.

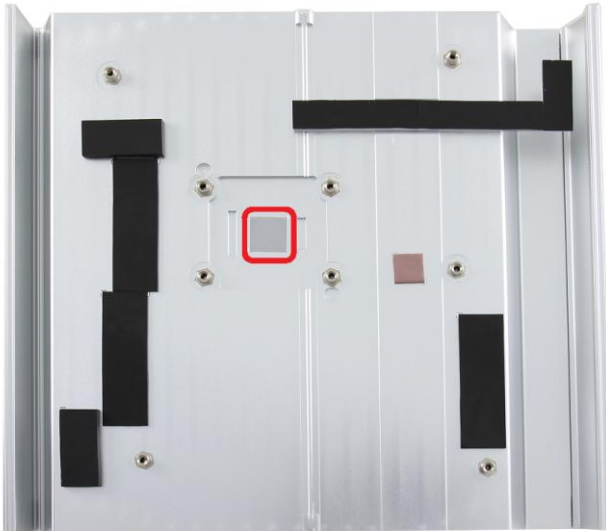

6. Follow steps described in step 4 to step 8 in section 3.2.1 to install a new CPU to your Nuvo-5095GC controller.

3.3 Install DDR4 SODIMM Module

Nuvo-5095GC series provides two 260-pin, SODIMM sockets for installing DDR4 memory modules. It supports maximal 32GB capacity by installing two 16 GB DDR4-2133 SODIMM modules. You can install/replace DDR4 SODIMM modules by following the steps described in this section.

1. Follow the steps described in section 3.1 to disassemble the Nuvo-5095GC chassis. You can see the DDR4 SODIMM sockets on the PCBA exposed.
2. Tile the SODIMM module and insert it to the SODIMM socket. As it's firmly contacted with socket connectors, press it down until the clamps of the socket snap into the latching position of SODIMM module.

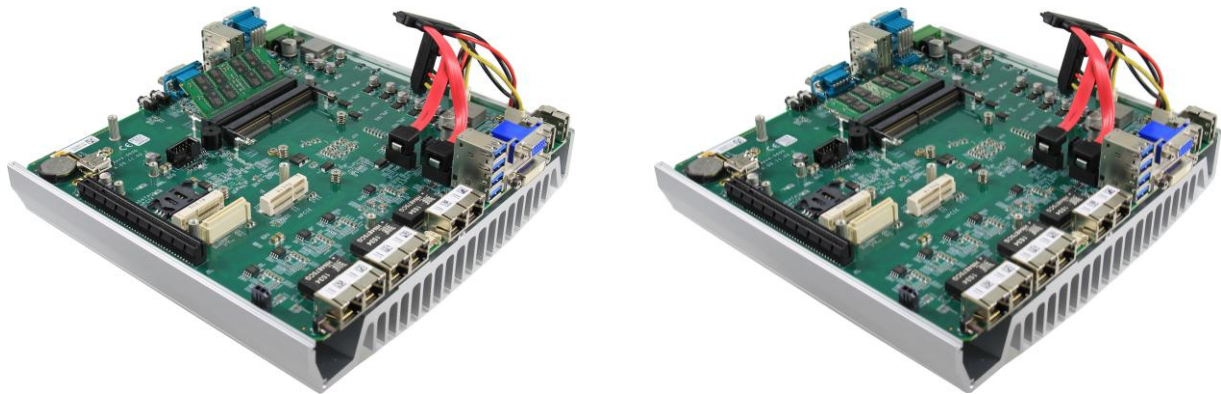

3. Repeat step 2 if you want to install the second DDR4 SODIMM module.

3.4 Install 2.5" SATA HDD/SSD

Nuvo-5095GC series has two SATA ports for connecting SATA HDD or SSD drives. They are used in conjunction with the HDD bracket on the trap-door to accommodate two 2.5" HDD/SSD. Please follow instructions described in this section to install SATA HDD/SSD to your Nuvo-5095GC controller.

1. Put the Nuvo-5095GC controller upside down on a flat surface. You can see the trapdoor exposed. Use a Philips screwdriver to loosen three M3 flat-head screws and remove the trapdoor from the bottom cover.



2. Get the HDD thermal pad from the accessory box. Remove protective films on both sides and place the thermal pad on the center of HDD bracket.



3. Place the HDD/SSD into the bracket and gently push it down to make it contact with the thermal pad. Use a Philips screwdriver to fix it with M3 flat-head screws from the accessory box. Please note that the HDD must be placed in the right direction as below.



4. Pull out the SATA cable inside the chassis and connect it to HDD/SSD.



5. Place the HDD/bracket assembly back to the bottom cover. And fix it with three M3 flat-head screws.



3.5 Install Mini-PCle Module

Nuvo-5095GC series provides two full-size mini-PCle sockets with SIM card support. You can install off-the-shelf mini-PCle modules to expand functions for Nuvo-5095GC controller. In this section, we demonstrate how to install a mini-PCle 3G module and its antenna to the Nuvo-5095GC controller.

1. Follow the steps described in section 3.1 to disassemble the Nuvo-5095GC controller. You can see mini-PCle sockets on the PCBA exposed.

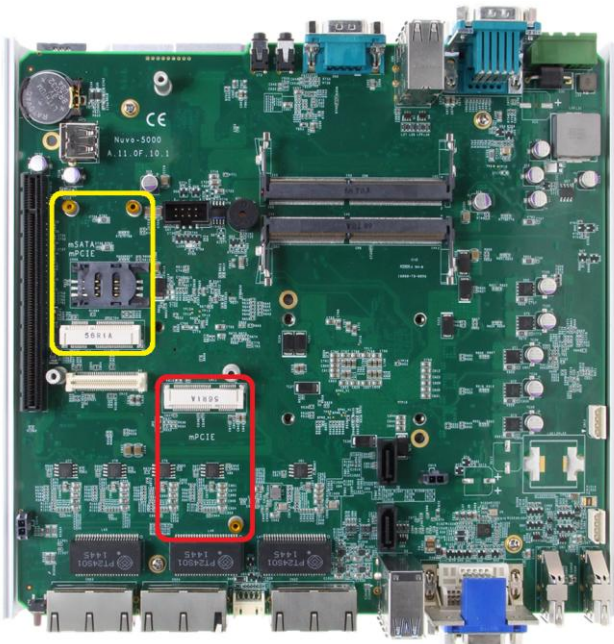

2. Tilt the mini-PCle 3G module and insert it into the mini-PCle #2 socket (marked as red). And fix the module with one M2.5 P-head screw.



3. Attach the IPEX-to-SMA cable to the 3G module.



4. Fix the SMA connector of the IPEX-to-SMA cable to one of the four antenna apertures on either front panel or back panel.



5. Recover the front panel, back panel and the bottom cover and attach a 3G antenna to the SMA connector. The mini-PCle #2 socket shall be used in conjunction with the panel-accessible SIM socket on the back panel. Insert the SIM card upside down to the SIM socket to support 3G communication for your Nuvo-5095GC controller.



3.6 Install MezIO™ Module

Nuvo-5095GC series is designed with Neosys' MezIO™ interface. You can install a MezIO™ module to expand application-oriented I/O function. In this section, we demonstrate the procedure of installing Neosys MezIO-C180 to add eight additional COM ports to your Nuvo-5095GC controller.

1. Follow the steps described in section 3.1 to disassemble the Nuvo-5095GC controller. You can see MezIO™ interface connector on the PCBA.

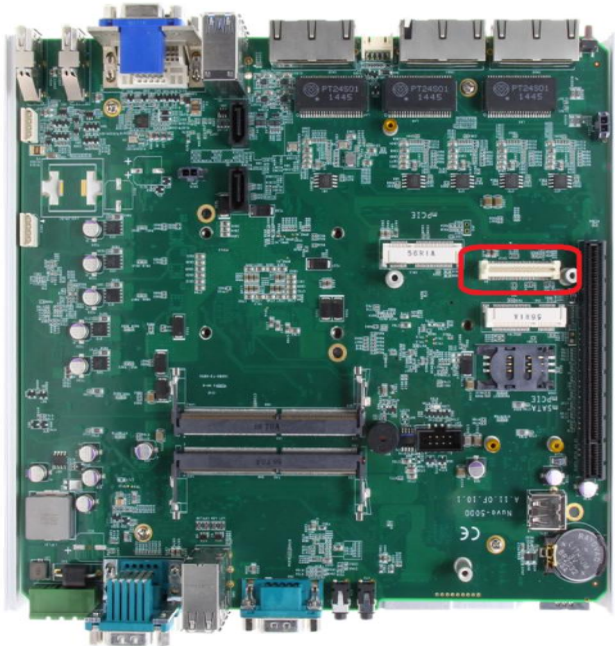

2. Align the board-to-board connector on the MezIO-C180 module to to connector on the PCBA. Gently push it down and make sure the connector is firmly contacted. Fix the MezIO™ module with three M3 P-head screws.

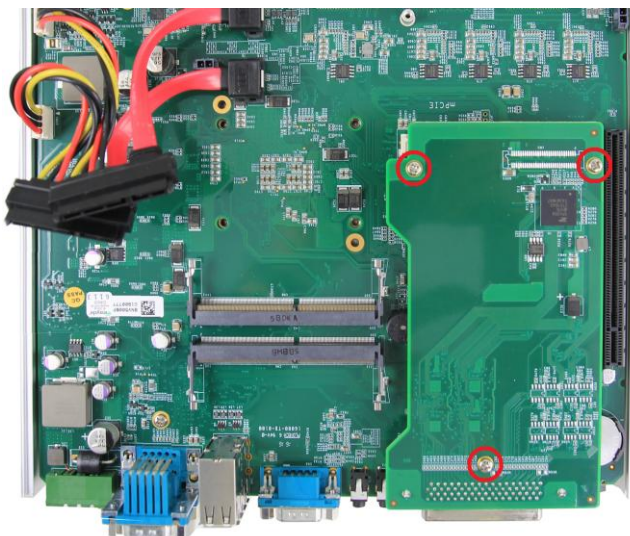

3. Remove the pre-cutting plate of MezIO™ I/O aperture on the back panel to expose the SCSI-II 68-pin connector of the MezIO-C180 module.

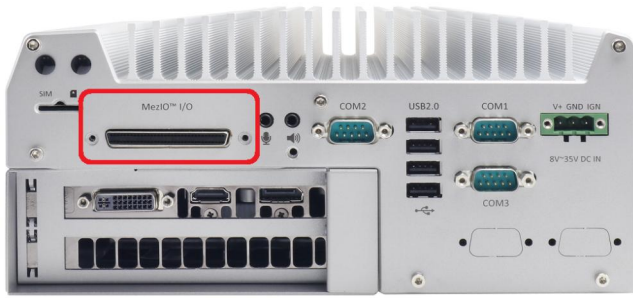

3.7 Install nVidia® Graphics Card in Cassette

The expansion Cassette is designed to accommodate nVidia® GTX 950 and GTX 1050 graphics card. To get best thermal stability for GPU operation, please install either industrial-grade graphics card provided by Neosys or consumer-grade graphics card listed in section 1.4. In this section, we illustrate the procedure of installing ASUS ASUS GeForce® GTX950-M-2GD5 graphics card in the expansion Cassette of Nuvo-5095GC controller.

1. Remove Cassette from Nuvo-5095GC controller by loosening four M4 screws.



2. Open the cover of Cassette by loosening three M3 flat-head screws.



3. Get four pieces of PORON® form strips from the accessory box. For ASUS GeForce® GTX950-M-2GD5, please use PORON® form strip of 2.5 mm thickness. For GIGABYTE GeForce® GTX 1050 D5 2G, please use PORON® form strip of 10 mm thickness.

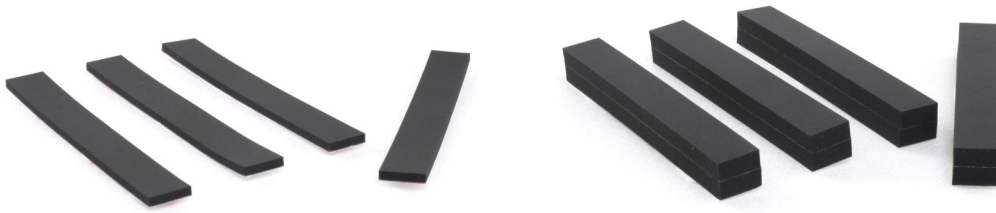

2.5 mm PORON® form

10 mm PORON® form

4. Stick PORON® form strips to the specific positions of Cassette cover.



5. Get four pieces of rubber spacers from the accessory box. The spacers are used to support graphics card when installed. Stick the rubber spacers to the back side of the graphics card. It's highly recommended to place them evenly around the outer of GPU fan.

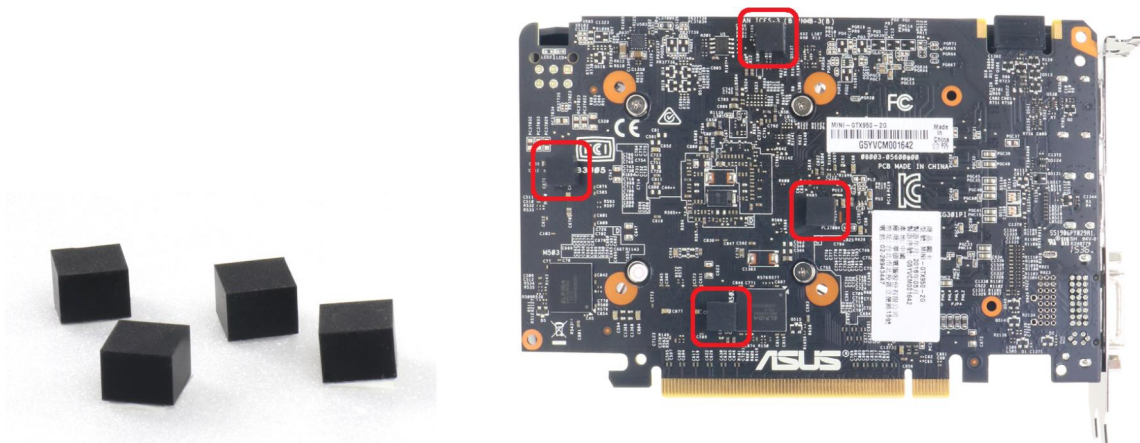

6. Install the graphics card into the x16 PCIe slot. Make sure the “golden finger” connector is firmly contacted with PCIe connector and the faceplate of the graphics card is well inserted to the groove underneath

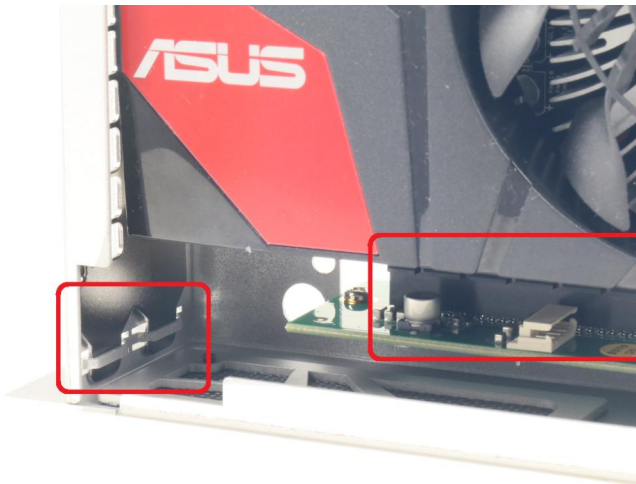

7. Fix the graphics card using two M3, PW-head screws.



8. Recover the Cassette cover and fix it with three M3, flat-head screws. And put Expansion Cassette back to Nuvo-5095GC controller, and fix it using four M4 screws.

3.8 Mount your Nuvo-5095GC

Nuvo-5095GC series features a patented mechanical design which creates sealed tunnel for intake air flow. To obtain best efficiency for heat dissipation, it's required to keep enough clearance beneath the bottom side of Nuvo-5095GC controller. Nuvo-5095 series is shipped with stand-off brackets which can create 20 mm clearance. To mount your Nuvo-5095GC controller on the wall or flat surface, please refer to the instructions listed below.

Caution

For customers who have customized mounting design, please make sure you have at least 20 mm clearance beneath Nuvo-5095GC controller. Mounting Nuvo-5095GC without enough clearance may significantly reduce GPU performance at high ambient temperature.

1. Get two wall-mounting brackets and four M4 screws from the accessory box. Fix the mounting brackets to Nuvo-5095GC using M4 screws.

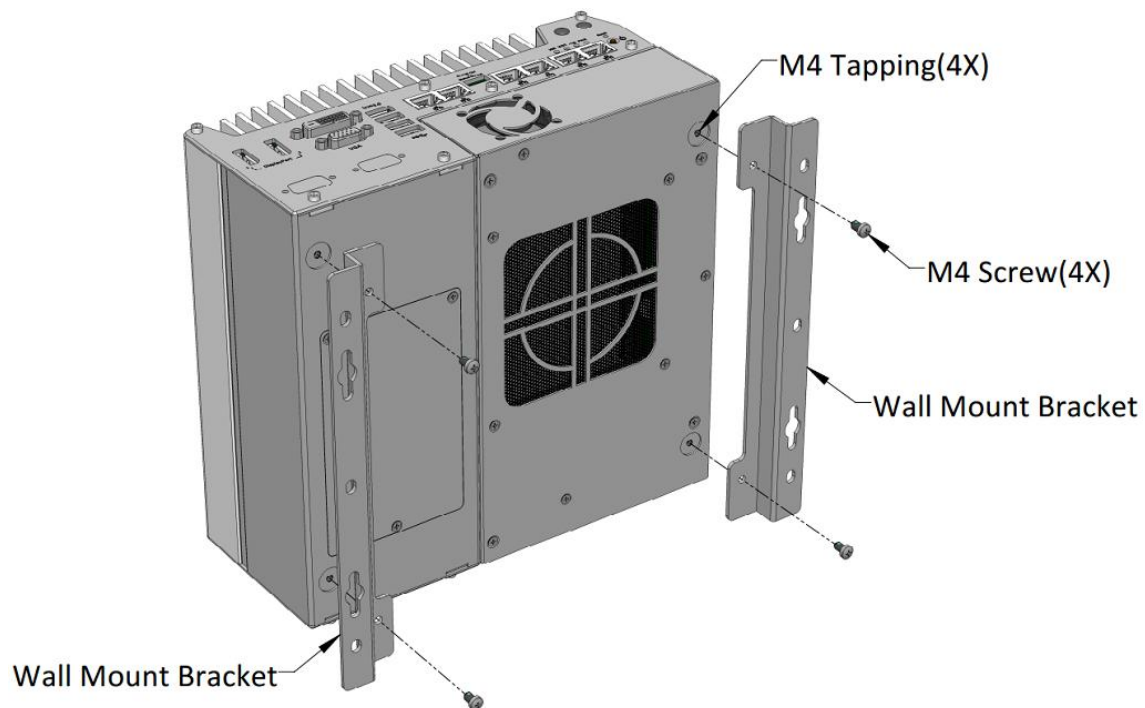

- Place Nuvo-5095GC controller on a flat surface and fix it with screws. You can also take advantage of the keyhole-shaped holes of mounting brackets to suspend the Nuvo-5095GC controller on the Wall.

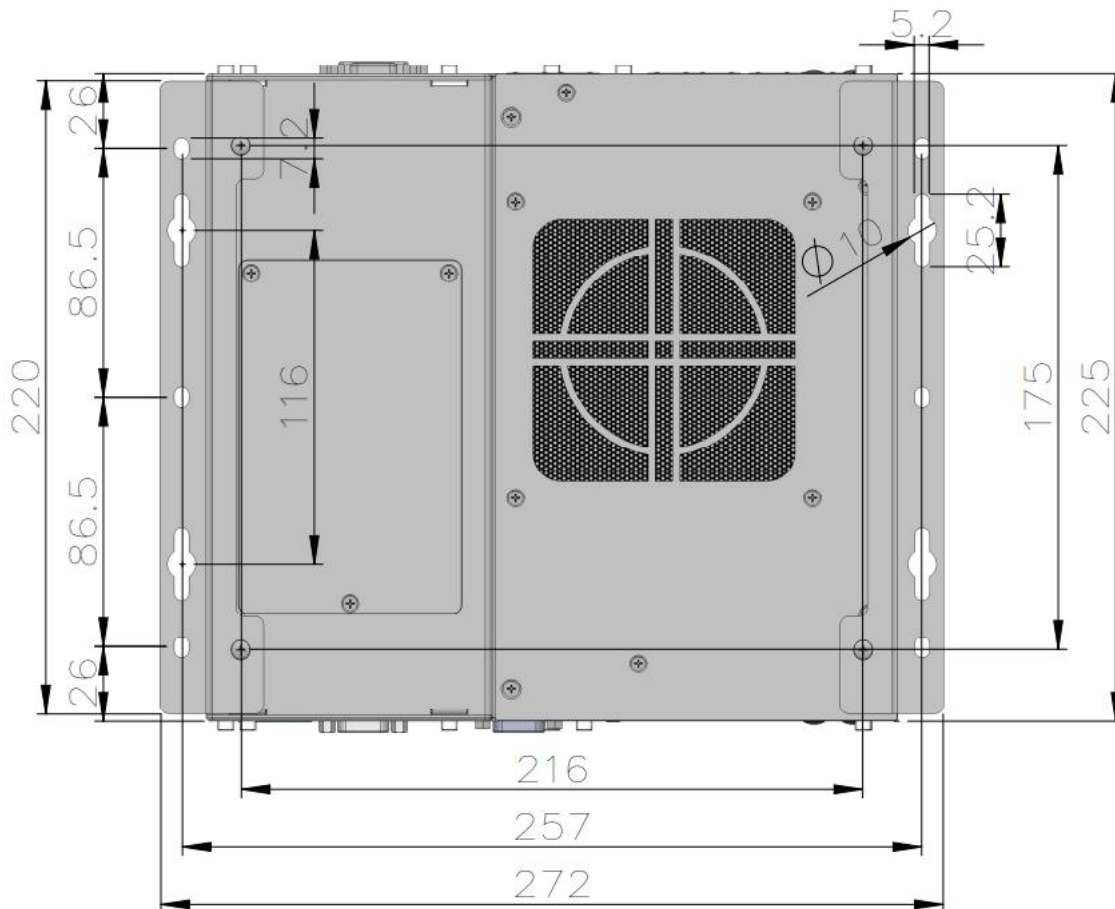

- For the case of wall-mounting, please mount your Nuvo-5095GC controller in a right direction for better efficiency of heat dissipation.

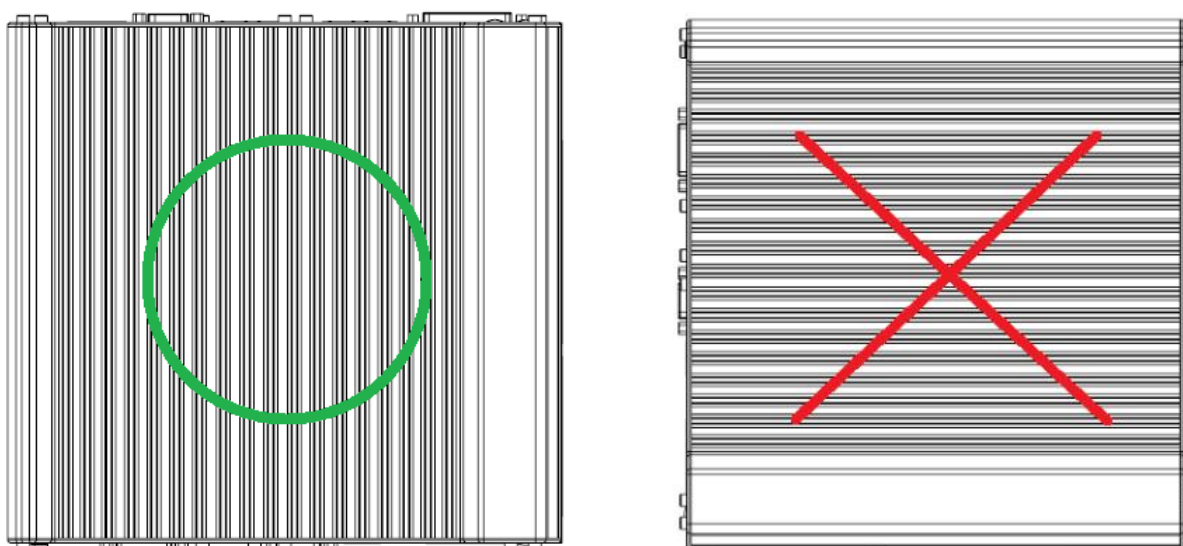

3.9 Connect DC Power to your Nuvo-5095GC

Nuvo-5095GC series uses a 3-pin pluggable terminal block to accept 8~35V DC power input. It provides a reliable way for directly wiring the DC power. The pluggable terminal block is also used to accept ignition signal if MezIO-V20 ignition control module is installed. To connect DC power via the 3-pin pluggable terminal block, please follow the steps described below.

Caution

Considering the total power consumption of GPU (max. 75W) and CPU (max. 65W), please use a power supply with at least 160W power output.

1. Make sure the external DC power supply is power off or disconnected before wiring.
2. Get the 3-pin pluggable terminal block from the accessory box. The terminal block fits the wires with a gauge of 12~24 AWG.
3. Carefully identify the positive and negative contacts of your DC power supply and pluggable terminal block. The polarities between DC power supply and terminal block must be positive (+) to positive (+) and ground (GND) to ground (GND).

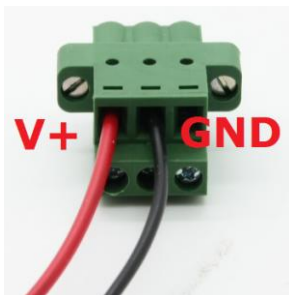

4. Insert the wires to correct contacts of pluggable terminal block and tighten clamping screws using a Philips screwdriver.
5. Firmly plug the terminal block into a receptacle on the rear panel, and tighten the captive screws using a Slotted screwdriver.

Caution

1. *Nuvo-5095GC series accepts 8~35 VDC when using terminal block for DC input. Please make sure the voltage and polarity of DC power is correct before you connect it to Nuvo-5095GC controller. Supplying a voltage over 35V or incorrect polarity will damage the system.*

3.10 Power on your Nuvo-5095GC Controller

For the flexibility of operation, Nuvo-5095GC series provides three alternatives to power on your Nuvo-5095GC controller. You can turn on your Nuvo-5095GC controller by pressing the power button, using an external non-latched switch, or by sending a special LAN packet. In this section, we illustrate these ways to power on your Nuvo-5095GC controller.

3.10.1 Power on Nuvo-5095GC Using the Power Button

This is the simplest way to turn on your Nuvo-5095GC controller. The power button on the front panel is a non-latched switch and behaves the ATX-mode on/off control. As DC power is connected, push the power button will turn on the system as well as the PWR LED indicator. Push the button when system is on will turn off the system. If your operating system supports ATX power mode (i.e. Microsoft Windows or Linux), push the power button causes a pre-defined system behavior, such as shutdown or hibernation.



3.10.2 Power on Nuvo-5095GC Using an External Switch

For an application which places Nuvo-5095GC controller inside a cabinet, it's useful to control the on/off of the system using an external switch. Nuvo-5095GC series provides a 2x5, 2.0mm pitch wafer connector (for detail, please refer to section 2.2.5) for connecting a non-latched switch and behaves ATX-mode power on/off control. The external non-latched switch acts exactly the same as the power button on the front panel. To power on Nuvo-5095GC controller using an external non-latched switch (ATX-mode), please follow the steps described below.

1. Prepare a non-latched switch with a 2x5, 2.0mm pitch wafer terminal. Note that the switch must be connected to pin#1 and pin#2 (polarity is negligible).

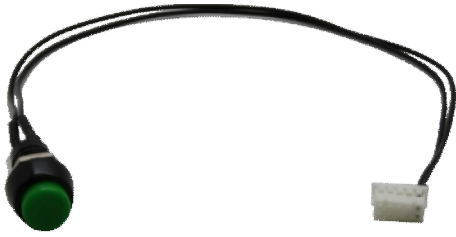

2. Connect the wafer terminal to the wafer connector on the front panel of the Nuvo-5095GC controller.

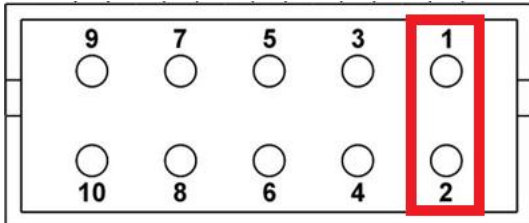

3. Push the non-latched switch will turn on the system (the PWR LED indicator on the front panel is on at the same time). Push the non-latched switch when system is on will turn off the system. If your operating system supports ATX power mode (i.e. Microsoft Windows or Linux), push the power button causes a pre-defined system behavior, such as shutdown or hibernation.

3.10.3 Power on Nuvo-5095GC Using Wake-on-LAN Function

Wake-on-LAN (WOL) is a mechanism to wake up a computer system from a S5 (system off with standby power) state via issuing a magic packet. Nuvo-5095GC series implements the Wake-on-LAN function for the GbE port marked below.



To enable WOL function and power on you Nuvo-5095GC controller, please follow the steps described below.

1. When Nuvo-5095GC controller boots up, press F2 to enter BIOS setup utility.
2. Enter the **[Power]** menu. And configure the **[Wake On LAN]** option as **[Enabled]**. This setting enables the Wake-on-LAN function for Nuvo-5095GC series. Please refer to section 4.1.5 for the instruction of configuring this BIOS option.

- In Windows 7 system, identify the Local Area Connection of corresponding Intel® I219 Gigabit Controller and click the **Configure** button.

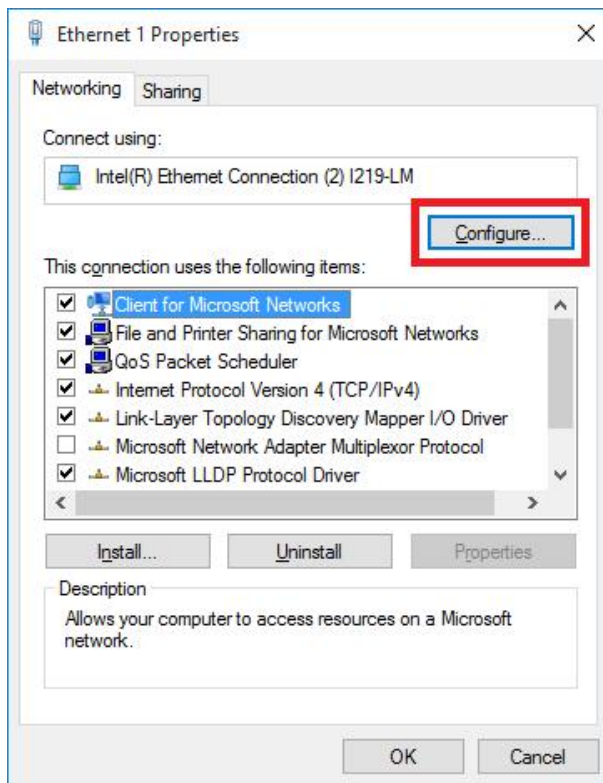

- Click the **Power Management** tag, and check the following two options accordingly

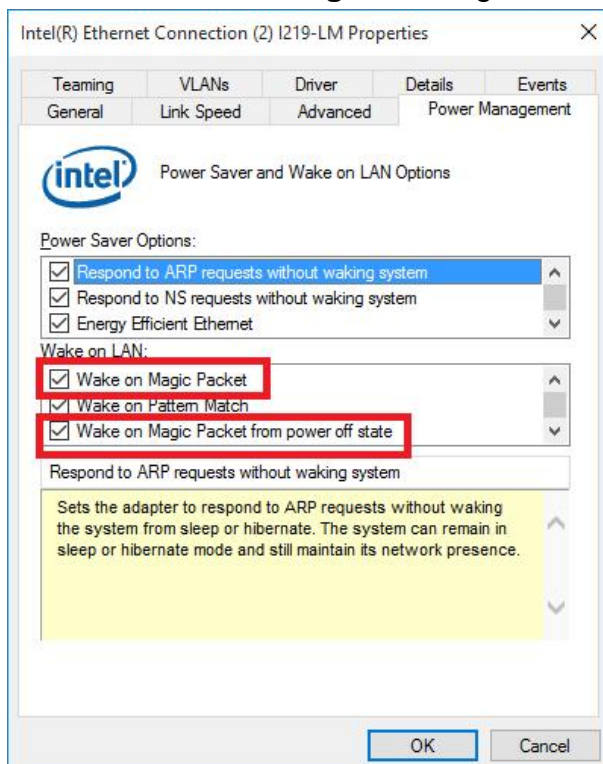

- **Wake on Magic Packet**

Nuvo-5095GC series can wake from S5 state when receiving a magic packet. The magic packet is a broadcast frame containing anywhere within its payload 6 bytes of all 255 (FF FF FF FF FF FF in hexadecimal), followed by sixteen repetitions of

the target computer's 48-bit MAC address.

For example, NIC's 48-bit MAC Address is 78h D0h 04h 0Ah 0Bh 0Ch

DESTINATION SOURCE MISC

FF FF FF FF FF FF

78 D0 04 0A 0B 0C 78 D0 04 0A 0B 0C

78 D0 04 0A 0B 0C 78 D0 04 0A 0B 0C

78 D0 04 0A 0B 0C 78 D0 04 0A 0B 0C

78 D0 04 0A 0B 0C 78 D0 04 0A 0B 0C

78 D0 04 0A 0B 0C 78 D0 04 0A 0B 0C

78 D0 04 0A 0B 0C 78 D0 04 0A 0B 0C

78 D0 04 0A 0B 0C 78 D0 04 0A 0B 0C

78 D0 04 0A 0B 0C 78 D0 04 0A 0B 0C

MISC CRC

There are some free tools available on Internet that can be used to send a magic packet. Please refer to the following link to understand more about Magic Packet.

<http://en.wikipedia.org/wiki/Wake-on-LAN>

Chapter 4 BIOS and Driver

4.1 BIOS Settings

Nuvo-5095GC series is shipped with factory-default BIOS settings cautiously programmed for best performance and compatibility. In this section, we'll illustrate some of BIOS settings you may need to modify. Please always make sure you understand the effect of change before you proceed with any modification.

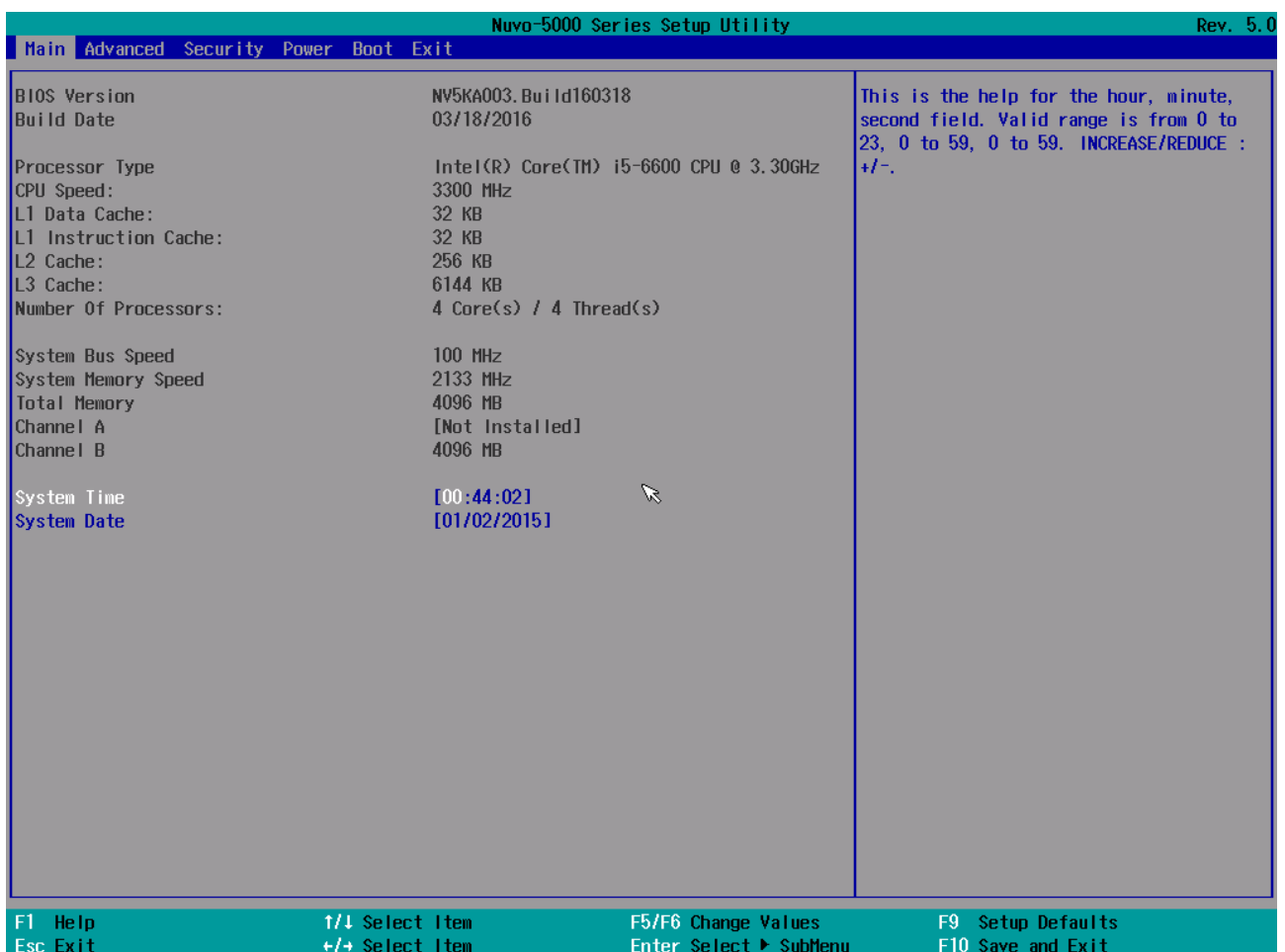

4.1.1 COM Port Configuration

There are totally five COM ports implemented on Nuvo-5095GC series. COM1, COM2 and COM3 are located on the back panel. COM4 and COM5 are internally used for Mezio™ interface.

COM1 and COM3 of Nuvo-5095GC series support RS-232 (full-duplex), RS-422 (full-duplex) and RS-485 (half-duplex) mode, while COM2 supports RS-232 mode only. You can set the operating mode of COM1/COM3 via BIOS settings. Another option in BIOS, “**Slew Rate**”, defines how sharp the rising/falling edge is for the output signal of COM1/COM3. For long-distance RS-422/485 transmission, you may set the “**Slew Rate**” option as “High” to improve signal integrity. For RS-422/485 communication, the “**RS-422/485 Termination**” option determines whether to enable/disable internal termination of RS-422/485 transceiver according to your wiring configuration (e.g. with or without external termination).

To configure COM1/COM3 operating mode:

1. When Nuvo-5095GC controller boots up, press F2 to enter BIOS setup utility.
2. Go to **[Advanced]** → **[Peripheral Configuration]**.
3. Set the **[Set COM1 as]** option to a proper mode for COM1.
4. Set the **[Set COM3 as]** option to a proper mode for COM3.
5. Set **[Slew Rate]** and **[RS-422/485 Termination]** if necessary according to your wiring configuration.

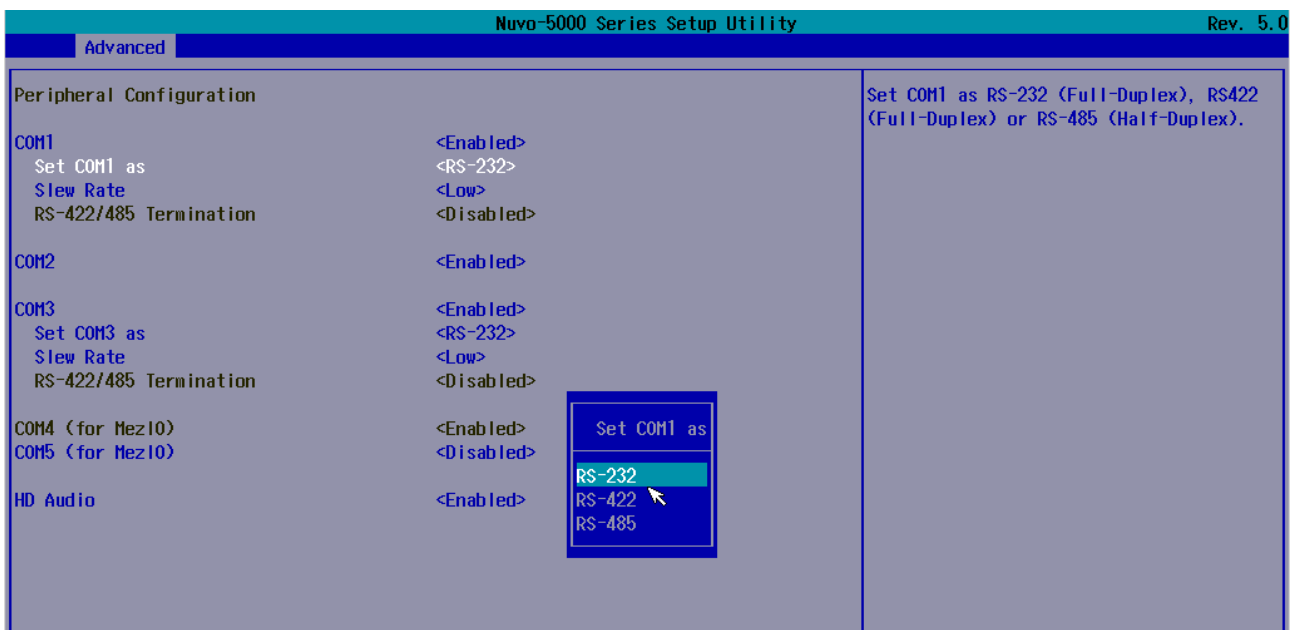

4.1.2 SATA Port Configuration

The SATA controller of Nuvo-5095GC series supports two operating modes: **AHCI** and **RAID** mode. **AHCI** mode, which exposes SATA's advanced capabilities such as hot swapping and native command queuing, is supported in most of modern operating systems. **RAID** mode provides a more reliable data storage (RAID 1/5/10) or a higher disk access throughput (RAID 0/5/10).

The RAID feature is built in Intel Q170 chipset with BIOS support. No additional H/W or driver is needed to use RAID function. You can configure the RAID volume during BIOS POST. Please refer to section 4.3 for detail.

To configure SATA controller operating mode:

1. When Nuvo-5095GC controller boots up, press F2 to enter BIOS setup utility.
2. Go to **[Advanced]** → **[SATA Configuration]**.
3. Set the **[SATA Mode Selection]** option to a proper mode for your Nuvo-5095GC controller.

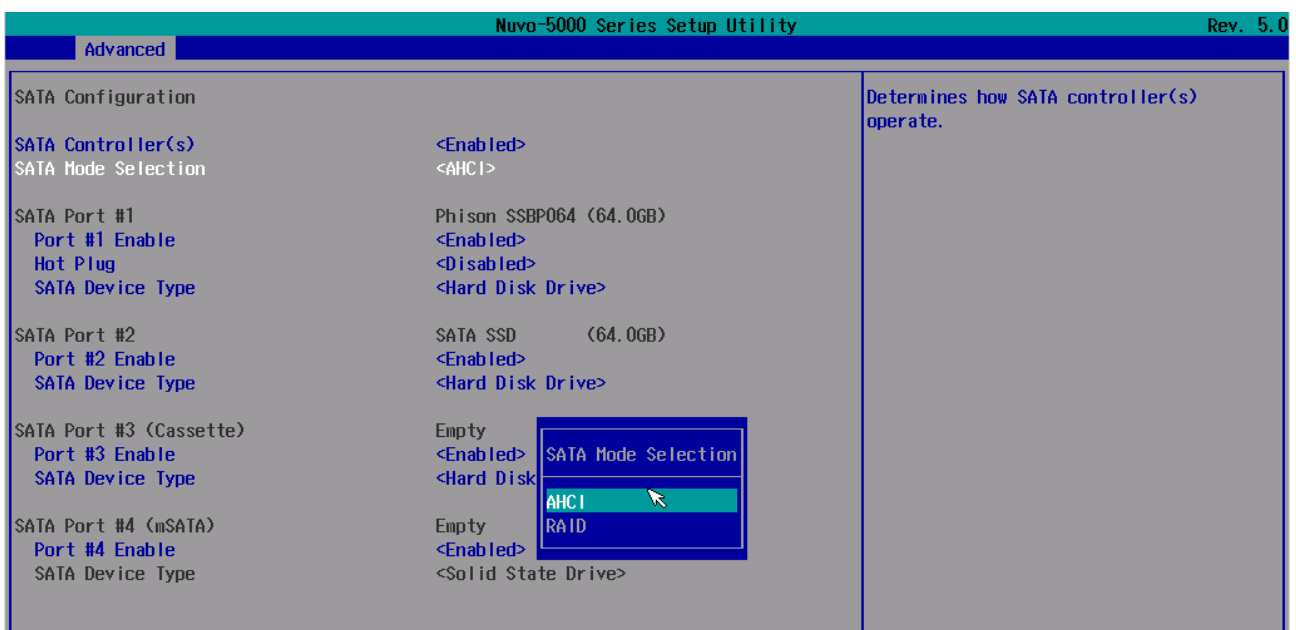

4.1.3 Enable TPM Feature

TPM, or Trusted Platform Module, is a hardware-based cryptoprocessor to secure hardware by integrating cryptographic keys into devices. Nuvo-5095GC series is designed with on-board TPM 2.0 module. As TPM 2.0 requires 64-bit Windows 7/8/10 with UEFI boot mode, it is disabled in BIOS by default. For customers who want to utilize TPM feature, you shall enable TPM in BIOS as well as install Windows with UEFI mode.

To enable TPM 2.0 feature:

1. When Nuvo-5095GC controller boots up, press F2 to enter BIOS setup utility.
2. Go to **[Security]**.
3. Enable TPM by selecting “**Available**” for **[TPM Availability]** option.
4. You will also need to select UEFI boot mode for installing Windows. Please refer to section 4.1.7 for detail.

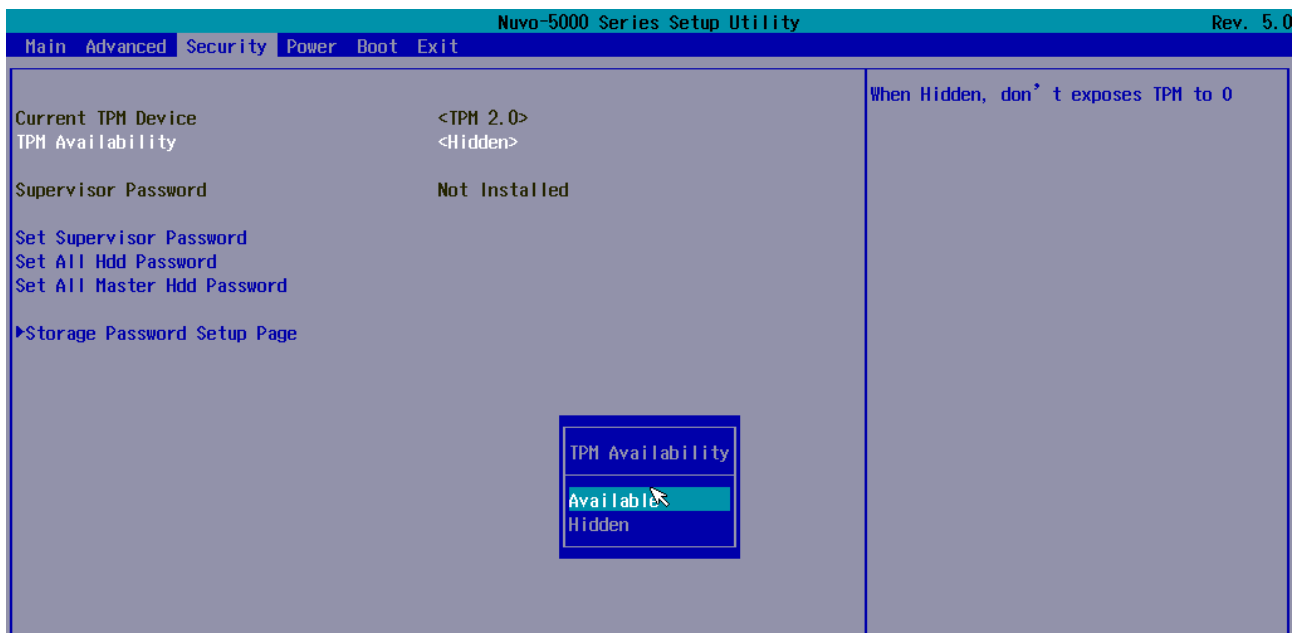

4.1.4 Configure CPU SKU Power

Nuvo-5095GC series supports a long list of 6th-gen Skylake LGA1151 CPU with up to 65W TDP. A unique feature, “**SKU Power Config**” is implemented in BIOS to allow users to specify user-defined SKU power limit for installed CPU according to deployment environment and power budget. For example, if a Nuvo-5095GC controller with 65W i7-6700 CPU installed is deployed in the environment of 60°C ambient temperature, you can limit the CPU to run with up to 45W TDP. This feature gives you the flexibility of CPU selection and great balance between computing power and operating temperature range.

Here is our suggestion regarding specifying SKU power for system with 65W/54W/51W CPU.

- For system running at up to 70°C ambient, specify SKU power to 35 W.
- For system running at up to 60°C ambient, specify SKU power to 45 W..
- For system running at up to 50°C ambient, specify SKU power to Max. TDP.

To configure the CPU SKU power limit:

1. When Nuvo-5095GC controller boots up, press F2 to enter BIOS setup utility.
2. Go to **[Power]** → **[Power & Performance]**.
3. Select a proper value of SKU power limit for **[SKU Power Config]** option.

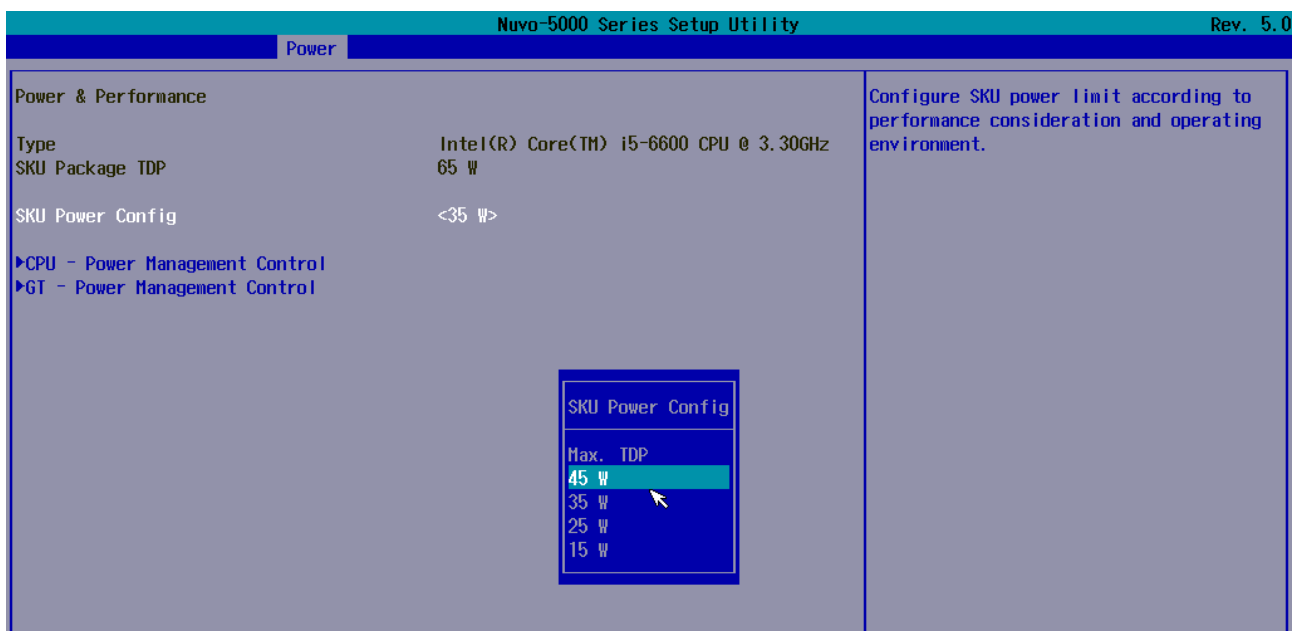

4.1.5 Wake-on-LAN Option

Wake-on-LAN (WOL) is a mechanism which allows you to turn on your Nuvo-5095GC controller via Ethernet connection. To utilize Wake-on-LAN function, you need to enable this option first in BIOS settings. Please refer to section 3.10.3 for instructions of using WOL function.

To enable/disable “Wake on LAN” option:

1. When Nuvo-5095GC controller boots up, press F2 to enter BIOS setup utility.
2. Go to **[Power]**.
3. Enable/disable the **[Wake on LAN]** option according to your application.

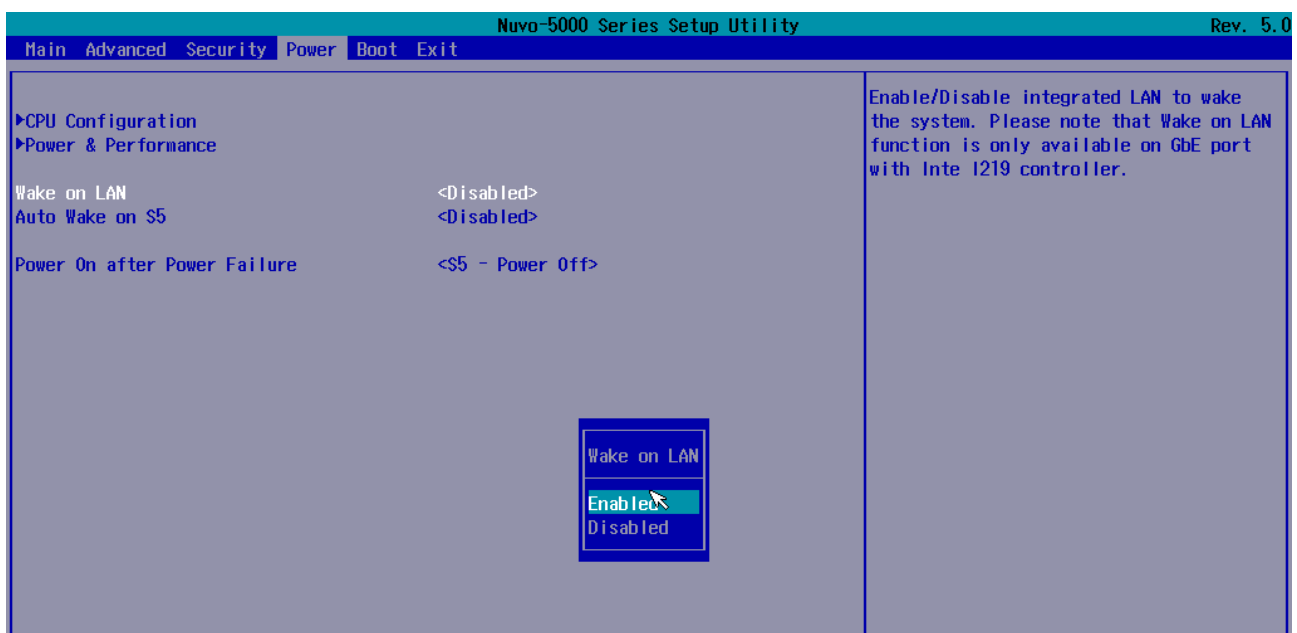

4.1.6 Power On after Power Failure Option

The “Power On after Power Failure” option defines the behavior of Nuvo-5095GC controller when DC power is supplied.

Value	Description
S0 – Power On	System is powered on when DC power is supplied.
S5 – Power Off	System is kept in off state when DC power is supplied.

To set “Power On after Power Failure” option:

1. When Nuvo-5095GC controller boots up, press F2 to enter BIOS setup utility.
2. Go to **[Power]**.
3. Set the **[Power On after Power Failure]** option to a proper value for your Nuvo-5095GC controller.

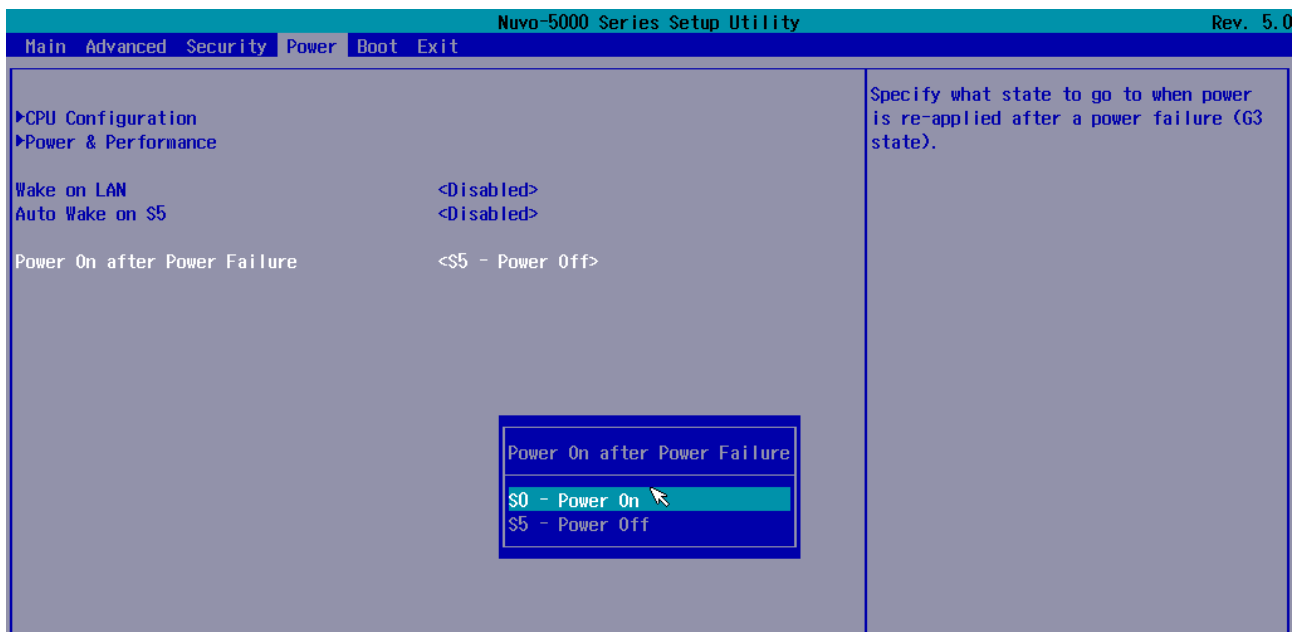

4.1.7 Configure Legacy/UEFI Boot Type

Nuvo-5095GC series supports both legacy and UEFI boot mode. UEFI, or Unified Extensible Firmware Interface, is a specification proposed by Intel to define a software interface between operating system and platform firmware. Most modern operating systems, such as Windows 7/8/10 and Linux, support both legacy and UEFI boot mode. Compared to that legacy boot uses MBR partition for disk and VBIOS for video initialization, UEFI boot uses GPT partition which supports > 2TB partition size and GOP driver for faster video initialization.

Here is our suggestion of choosing legacy boot or UEFI boot for your system.

- If you need > 2TB disk partition or want to use TPM 2.0 function, you shall choose UEFI boot mode and install operating system accordingly.
- Otherwise you can choose legacy boot mode for most cases.

To configure legacy or UEFI boot type:

1. When Nuvo-5095GC controller boots up, press F2 to enter BIOS setup utility.
2. Go to **[Boot]**.
3. Set the **[Boot Type]** option to a proper value for your Nuvo-5095GC controller.

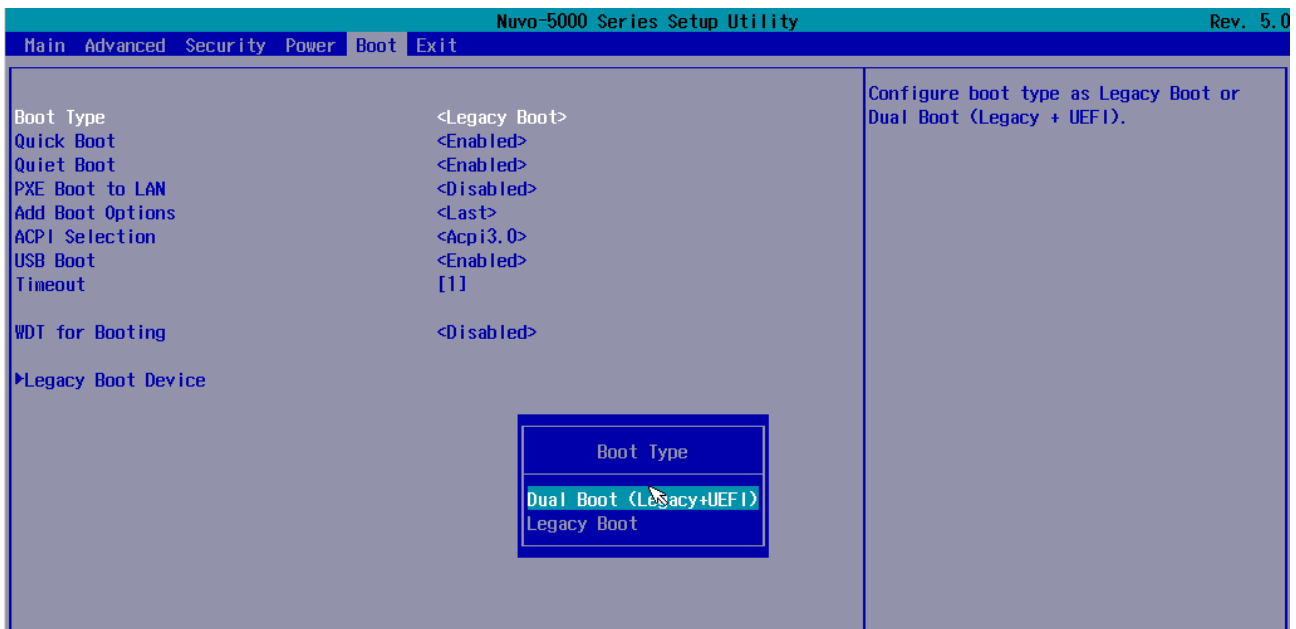

4.1.8 Position New Boot Device

When you plug a newly-installed boot device (e.g. USB flash disk), this option allow you determine whether to place the new boot device in the first place or the last place in the boot sequence.

1. When Nuvo-5095GC controller boots up, press F2 to enter BIOS setup utility.
2. Go to **[Boot]** menu.
3. The **[Add New Boot Device]** option decides whether to place the newly-installed boot device to the “**First**” place or the “**Last**” place in the boot sequence.

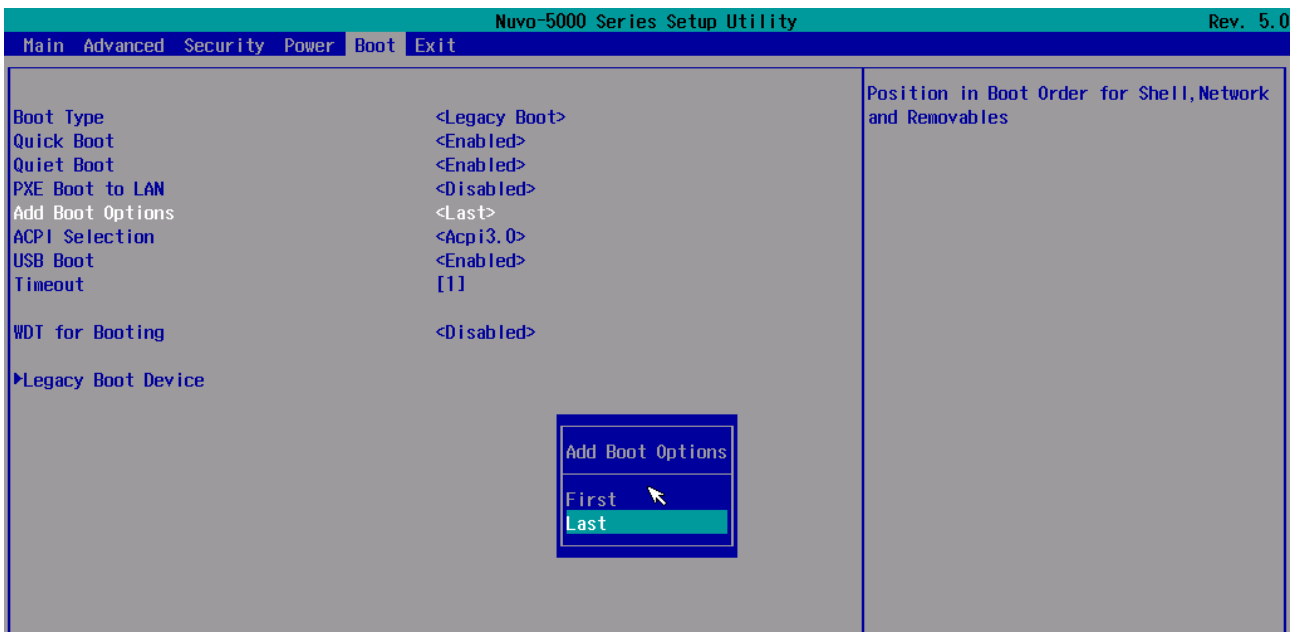

4.1.9 Watchdog Timer for Booting

The BIOS of Nuvo-5095GC series has a useful feature which allows users to use the watchdog timer to secure the booting process. You can specify the timeout value for watchdog timer. Once the watchdog timer expires, the BIOS issues a reset command to initiate another booting process. You can also set the behavior of how to stop the watchdog timer. There are two options in BIOS menu, “**Automatically after POST**” and “**Manually after Entering OS**”. When “**Automatically after POST**” is selected, the BIOS automatically stop the watchdog timer after POST (Power-On Self Test) OK. When “**Manually after Entering OS**” is selected, it's user's liability to stop the watchdog timer when entering OS. This guarantees the system can always boot to OS, otherwise another booting process will be initiated. For information about programming watchdog timer, please refer to **Appendix B Using Watchdog Timer**.

To set the watchdog timer for boot in BIOS:

1. When Nuvo-5095GC controller boots up, press F2 to enter BIOS setup utility.
2. Go to [**Boot**] menu.
3. Disable or select timeout value for [**WDT for Booting**] option.
4. Once you give a timeout value, the [**WDT Stop Option**] option appears. You can select “**Automatically after POST**” or “**Manually after Entering OS**”.

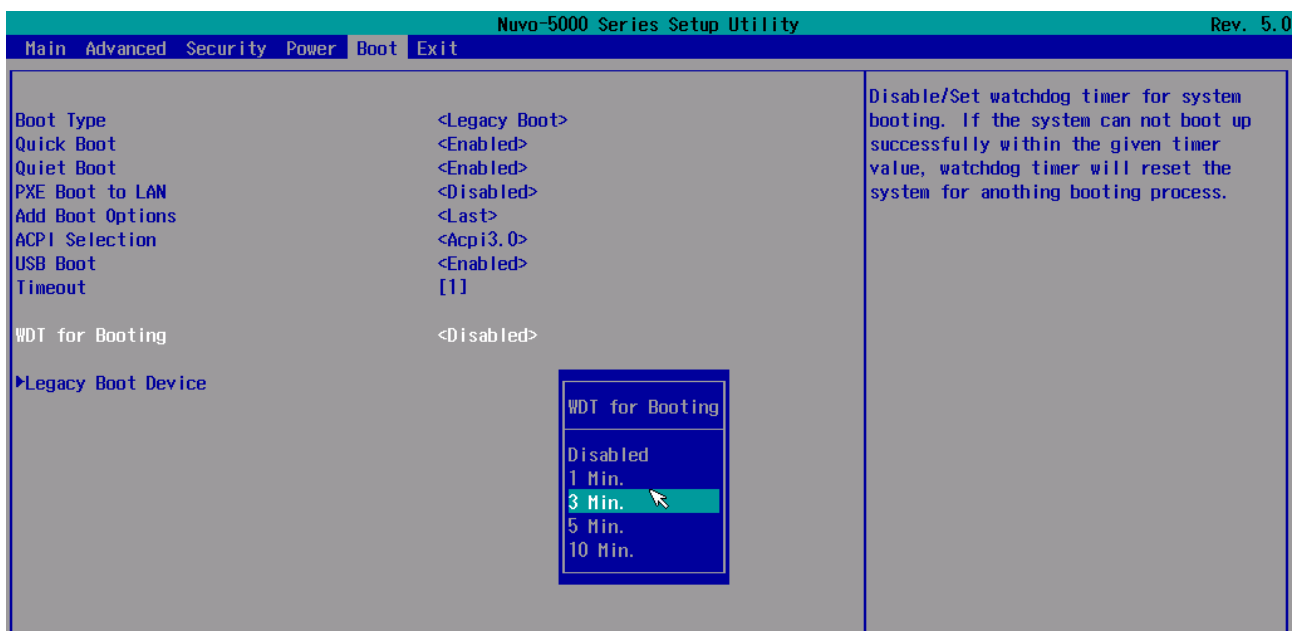

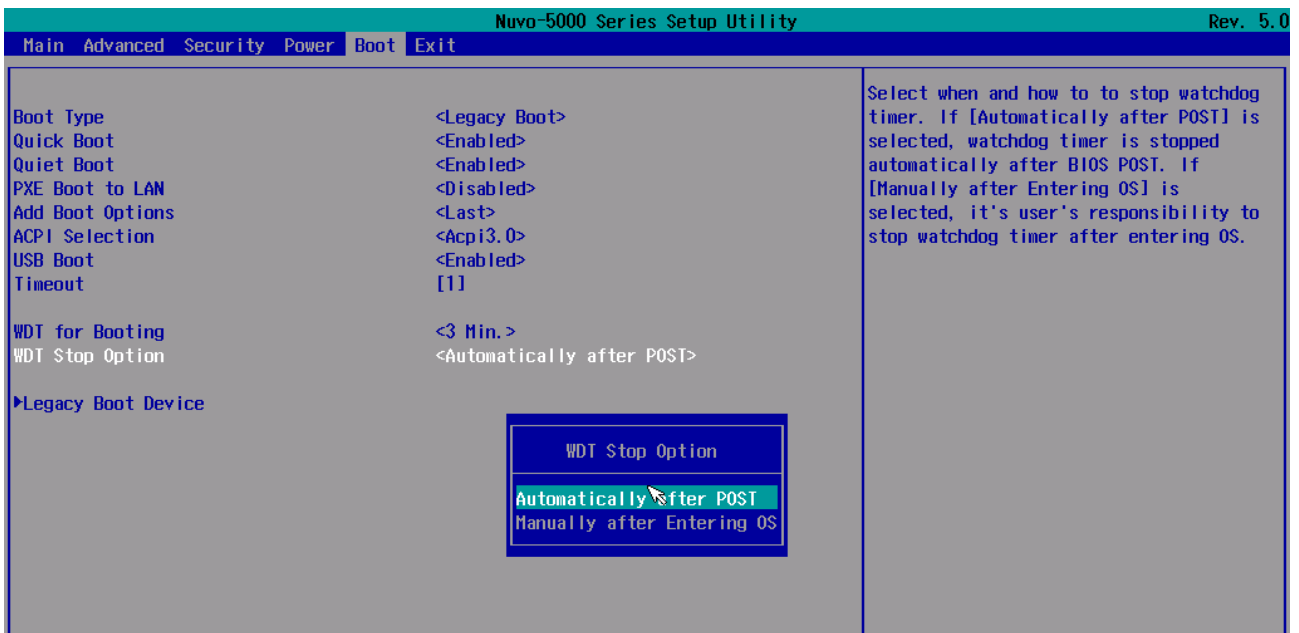

4.1.10 Select a Boot Device

When you have multiple bootable devices connected to your Nuvo-5095GC controller (e.g. HDD, mSATA, USB flash disk, USB DVD-drive), you may need to select one of them as the boot device. There are two ways to select the device. You can either, press F12 when system boots up to go to Boot Manager and then select one of the devices, or select the boot device in BIOS settings.

To select a boot device in UEFI boot mode:

1. When Nuvo-5095GC controller boots up, press F2 to enter BIOS setup utility.
2. Go to **[Boot] → [UEFI Boot Device]**.
3. Use F5/F6 or +/- to change the order of UEFI boot devices.

To select a boot device in legacy boot mode:

1. When Nuvo-5095GC controller boots up, press F2 to enter BIOS setup utility.
2. Go to **[Boot] → [Legacy Boot Device]**.
3. The **[Boot Menu]** option decides whether to list all bootable devices connected to your Nuvo-5095GC controller according to **[By Device]** or **[By Device Type]**. You can use F5/F6 or +/- to change the boot order of devices or device categories.

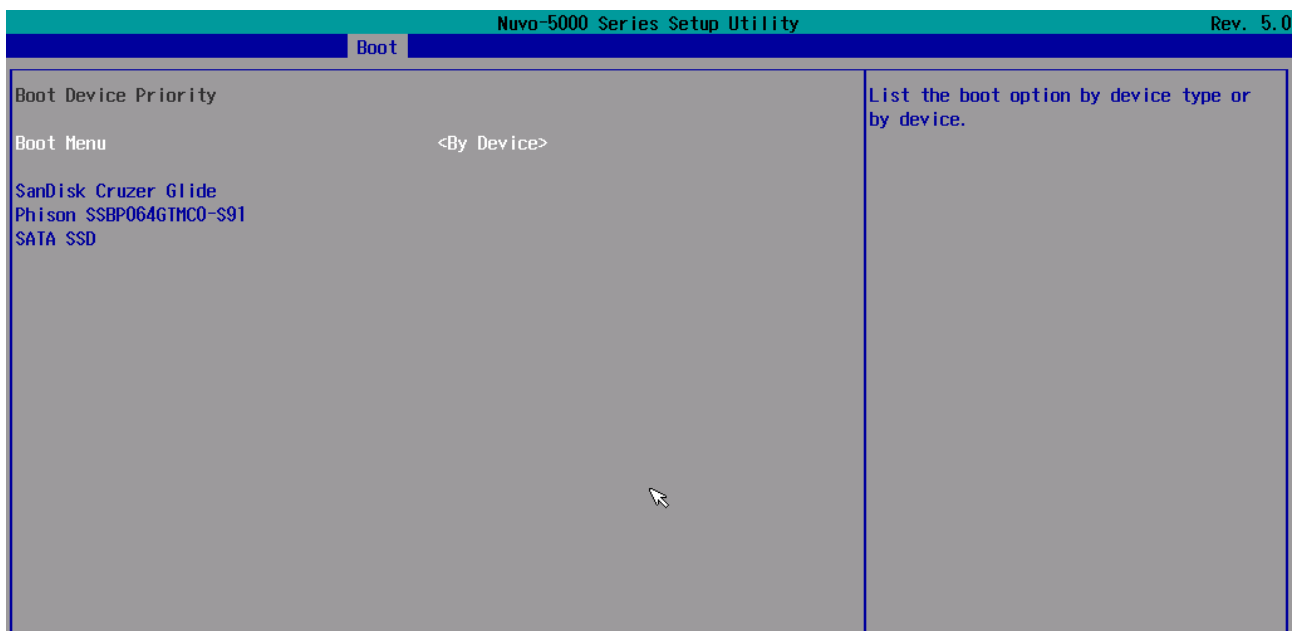

4.2 Configure AMT

Intel® AMT (Active Management Technology) is a hardware-based technology for remotely managing target PCs via Ethernet connection. Nuvo-5095GC series supports AMT function via its Ethernet port implemented with Intel I219-LM. In prior to use AMT to remotely control Nuvo-5095GC series, you need to configure AMT password and network settings.

1. Make sure you have Ethernet connection on the Ethernet port implemented via I219-LM of Nuvo-5095GC series.



2. Press F10 when Nuvo-5095GC controller boots up. A MEBx configuration page appears.

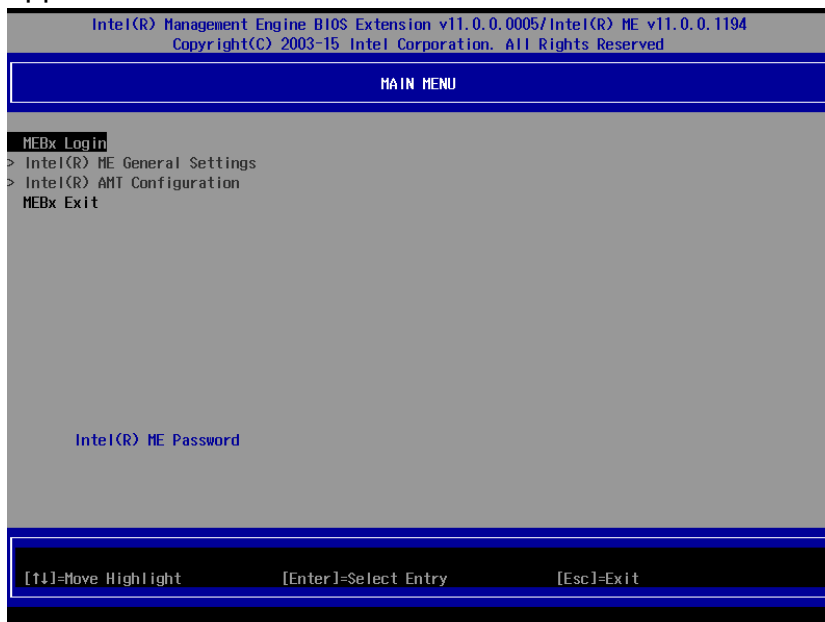

3. Select "MEBx Login" and you're asked for password. The default password is "**admin**". For further MEBx configuration, please refer to Intel® MEBX User Guide. You can find related information at <http://www.intel.com/support/motherboards/desktop/sb/CS-033768.htm>

4.3 Configure RAID Volume

Nuvo-5095GC series supports RAID function implemented by Q170 PCH for more reliable and efficient disk access. The built-in RAID supports RAID 0 (data stripping), RAID 1 (data mirroring), RAID 5 (data stripping + parity) and RAID 10 (data stripping + mirroring). You can configure RAID mode according to your application by following steps listed below.

1. Make sure you've configured SATA controller to **RAID** mode (refer to section 4.1.2 for further information).
2. Reboot Nuvo-5095GC controller, you will see a UI banner for RAID configuration.

```
Intel(R) Rapid Storage Technology - Option ROM - 14.0.0.2234
Copyright (C) Intel Corporation. All rights reserved.

RAID Volumes:
None defined.

Physical Devices:
ID   Device Model      Serial #           Size Type/Status(Vol ID)
2   Phison SSBP064GT  0757176400019671 59.6GB Non-RAID Disk
3   SATA SSD          073A092C00041319 59.6GB Non-RAID Disk
Press <CTRL-I> to enter Configuration Utility...
```

3. Press <CTRL-I> to enter RAID configuration page. You can create, delete or configure your RAID volume here.

```
Intel(R) Rapid Storage Technology - Option ROM - 14.0.0.2234
Copyright (C) Intel Corporation. All rights reserved.

[ MAIN MENU ]
1. Create RAID Volume          4. Recovery Volume Options
2. Delete RAID Volume         5. Acceleration Options
3. Reset Disks to Non-RAID    6. Exit
[ DISK/VOLUME INFORMATION ]

RAID Volumes:
None defined.

Physical Devices:
ID   Device Model      Serial #           Size Type/Status(Vol ID)
2   Phison SSBP064GT  0757176400019671 59.6GB Non-RAID Disk
3   SATA SSD          073A092C00041319 59.6GB Non-RAID Disk

[↑↓]-Select      [ESC]-Exit      [ENTER]-Select Menu
```

4.4 Operating System Support

Nuvo-5095GC series supports most modern operating systems developed for Intel® x86 architecture. The following list contains the operating systems which have been tested with Nuvo-5095GC series in Neosys Technology Inc.

- Microsoft Window 7 32-bit*
- Microsoft Window 7 64-bit*
- Microsoft Window 8.1 64-bit
- Microsoft Windows 10 64-bit
- OpenSUSE 42.1**
- Fedora 23**
- Ubuntu 14.04.4 LTS and 16.04 LTS**
- Debian 8.3**

* *Due to the nature that XHCI driver is not included natively in Windows 7, you may encounter the issue of USB keyboard/mouse not working when installing Windows 7. Neosys offers a Windows-based batch file and step-by-step guide to help you. Please refer to Appendix A for information of installing Windows 7 on Nuvo-5095GC.*

** *For some Linux distributions, graphics driver and RAID function may not be completely implemented in its kernel. You may encounter restrictions when using these features, such as triple independent display and RAID. It should be user's liability to manually upgrade related drivers if necessary.*

Neosys will keep this list updated as we continuously test other operating systems with Nuvo-5095GC series. Please contact us for the latest OS support list.



4.5 Driver Installation

Neosys provides a very convenient utility in “Drivers & Utilities DVD” to allow the “One-Click” driver installation. This utility automatically detects your Windows operating system and installs all necessary drivers to your Nuvo-5095GC controller with just one mouse click.

4.5.1 Install All Drivers Using “One-Click” Driver Installation

1. Insert the “Drivers & Utilities DVD” into a USB DVD-drive attached to your Nuvo-5095GC series. A setup utility launches and the following dialog appears.

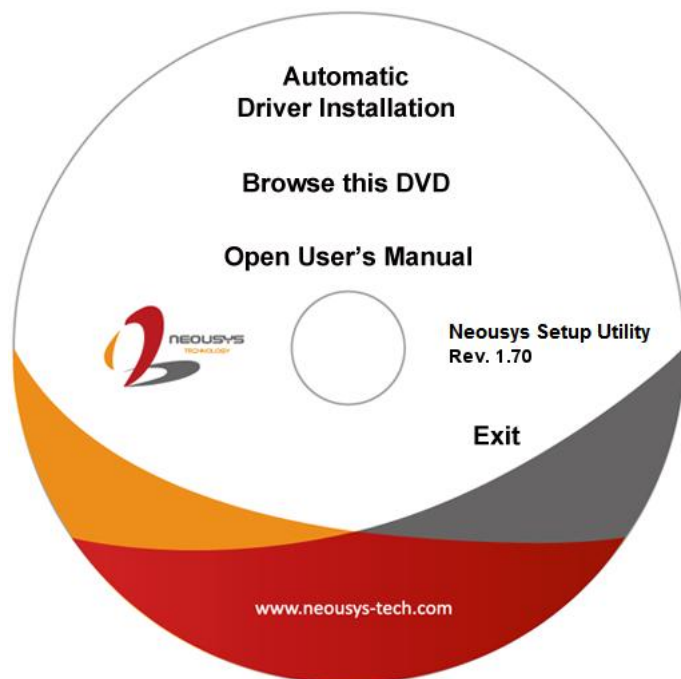

2. Click on the “**Automatic Driver Installation**”. The setup utility will automatically detect your Windows operating system and install all necessary drivers. According to different versions of Windows, the installation process takes about 6~8 minutes. Once driver installation is done, the setup utility reboots your Windows and your system works normally afterward.

4.5.2 Install Drivers Manually

You can also manually install each driver for Nuvo-5095GC series. Please refer to the following information about installing drivers for different operating system.

Windows 7 32-bit

The recommended driver installation sequence is

1. Chipset driver (x:\Driver_Pool\Chipset_10_Series\Win_ALL\SetupChipset.exe)
2. Graphics driver (x:\Driver_Pool\Graphics_6th_i7\Win_7_32\Setup.exe)
3. Audio driver (x:\Driver_Pool\Audio_ALC262\Win_ALL_32\Setup.exe)
4. LAN driver
(x:\Driver_Pool\GbE_I210_I350\Win_ALL_32\APPS\PROSETDX\Win32\DxSetup.exe)
5. ME driver (x:\Driver_Pool\ME_10_Series\Win_ALL_AMT\SetupME.exe)

Windows 7 64-bit

The recommended driver installation sequence is

1. Chipset driver (x:\Driver_Pool\Chipset_10_Series\Win_ALL\SetupChipset.exe)
2. Graphics driver (x:\Driver_Pool\Graphics_6th_i7\Win_7_8_10_64\Setup.exe)
3. Audio driver (x:\Driver_Pool\Audio_ALC262\Win_ALL_64\Setup.exe)
4. LAN driver
(x:\Driver_Pool\GbE_I210_I350\Win_ALL_64\APPS\PROSETDX\Winx64\DxSetup.exe)
5. TPM 2.0 driver (x:\Driver_Pool\TPM2\Win7_64\Windows6.1-KB2920188-v7-x64.msu)
6. ME driver (x:\Driver_Pool\ME_10_Series\Win_ALL_AMT\SetupME.exe)

Windows 8/8.1 64-bit

The recommended driver installation sequence is

1. Chipset driver (x:\Driver_Pool\Chipset_10_Series\Win_ALL\SetupChipset.exe)
2. Graphics driver (x:\Driver_Pool\Graphics_6th_i7\Win_7_8_10_64\Setup.exe)
3. Audio driver (x:\Driver_Pool\Audio_ALC262\Win_ALL_64\Setup.exe)
4. LAN driver
(x:\Driver_Pool\GbE_I210_I350\Win_ALL_64\APPS\PROSETDX\Winx64\DxSetup.exe)
5. ME driver (x:\Driver_Pool\ME_10_Series\Win_ALL_AMT\SetupME.exe)

Windows 10 64-bit

The recommended driver installation sequence is

1. Chipset driver (x:\Driver_Pool\Chipset_10_Series\Win_ALL\SetupChipset.exe)
2. Graphics driver (x:\Driver_Pool\Graphics_6th_i7\Win_7_8_10_64\Setup.exe)
3. Audio driver (x:\Driver_Pool\Audio_ALC262\Win_ALL_64\Setup.exe)



4. LAN driver
(x:\Driver_Pool\GbE_I210_I350\Win_ALL_64\APPS\PROSETDX\Winx64\DxSetup.exe)
5. ME driver (x:\Driver_Pool\ME_10_Series\Win_ALL_AMT\SetupME.exe)

4.5.3 Install Driver for WDT and Per-port PoE On/Off Control

Neosys provides a driver package which contain function APIs for WDT and per-port PoE power on/off control function. You should install the driver package (WDT_DIO_Setup.exe) in prior to use these functions. Please note that you must install WDT_DIO_Setup_v2.2.4 or later revision for Nuvo-5095GC series.

Windows 7 32-bit

Please execute the driver setup program in the following directory.

x:\Driver_Pool\WDT_DIO\XP_Win7_8_32\WDT_DIO_Setup_v2.2.4.exe

Windows 7/8/10 64-bit (x64)

Please execute the driver setup program in the following directory.

x:\Driver_Pool\WDT_DIO\Win7_8_64\WDT_DIO_Setup_v2.2.4(x64).exe

Windows 7/8/10 64-bit (WOW64)

Please execute the driver setup program in the following directory.

x:\Driver_Pool\WDT_DIO\Win7_8_WOW64\WDT_DIO_Setup_v2.2.4(wow64).exe



Appendix A Install Windows 7 on Nuvo-5095GC

Intel Skylake platform removes EHCI controller and supports USB 2.0 and USB 3.0 connectivity only through its xHCI controller. For Windows 8/8.1 and Windows10, no issue is anticipated due to native xHCI support in the OS. However, Windows 7 does not natively support xHCI thus manual installation of Intel's xHCI driver is required to support both USB storage device and USB keyboard/mouse during the OS installation process.

To install Windows 7 on Nuvo-5095GC, the simplest way is to create a USB thumb drive with Windows 7 installation files and Intel xHCI driver included. Neosys provides a Windows-based batch file and step-by-step guide to help you. Please follow instructions in this section to install Windows 7 on your Nuvo-5095GC.

A.1 Before We Start ...

Before we proceed with the creation of USB flash drive installer, please make sure you have the following items.

1. Windows 7 original installation DVD
2. USB thumb drive with at least 4 GB capacity
3. Software utility to create ISO image from DVD, e.g.
 - ImgBurn (<http://www.imgburn.com>)
 - Nero (<http://www.nero.com>)
4. Software utility to create bootable USB drive from ISO file, e.g.
 - Microsoft Windows USB/DVD Download Tool (<https://www.microsoft.com/en-us/download/windows-usb-dvd-download-tool>)
 - ISO to USB (<http://www.isotousb.com>)
5. You should have at least 10 GB disk space on your local drive.

A.2 Create USB Flash Drive Installer Step-by-Step

Step 1 - Create .ISO file from Windows 7 DVD

The first step is to create a .iso file from the Windows 7 DVD. Here we use ImgBurn (<http://www.imgburn.com>) to create the .iso file and save it to local drive.



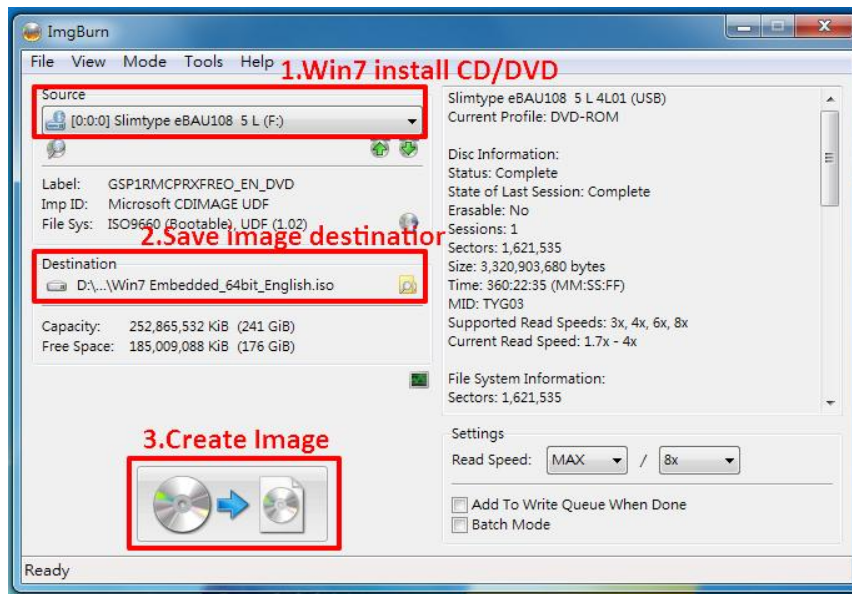

Step 2 - Create USB flash drive installer from .ISO

The next step is to create a bootable USB flash drive using the .iso file created in step 1. Here we use Microsoft Windows USB/DVD Download Tool to create the USB flash drive (<https://www.microsoft.com/en-us/download/windows-usb-dvd-download-tool>). Please note that the content of USB flash drive will be destroyed.

1. Right-click on the '**Windows 7 USB DVD Download Tool**' and select '**Run as administrator**'.
2. Follow the instructions below to create the USB flash drive installer.

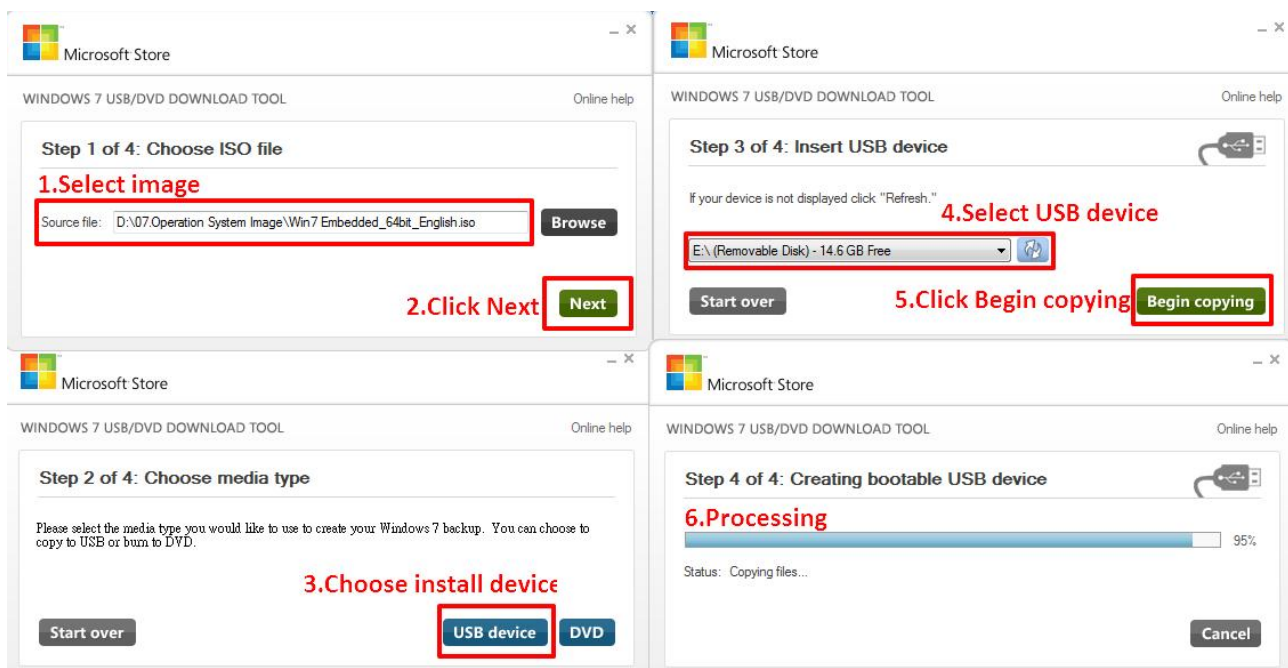

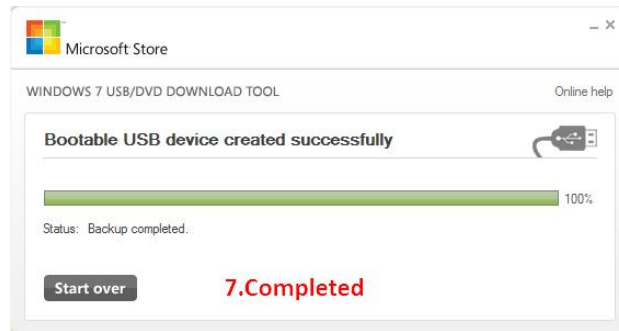

Step 3 - Create working folder on your local drive

In this step, we need to create a working folder on your local drive and copy necessary files to it. Please following the steps below.

1. Create a temporary working folder on your local drive. Here we use D:\WIM as an example.
2. Create another folder under D:\WIM for Intel xHCI driver files. Here we use \x86 for Win7 32-bit and \x64 for Win7 64-bit.
3. Copy xHCI driver files to the corresponding folder. You can find the driver files from Neousys Driver DVD.
 - For Win7 32-bit, copy all files from x:\Driver_Pool\USB3_10_Series\Win7_ALL\x86 to D:\WIM\x86
 - For Win7 64-bit, copy all files from x:\Driver_Pool\USB3_10_Series\Win7_ALL\x64 to D:\WIM\x64
 (where x: denotes the drive of your DVD drive)
4. Copy **install.wim** and **boot.wim** from \sources folder of your USB flash drive to D:\WIM.

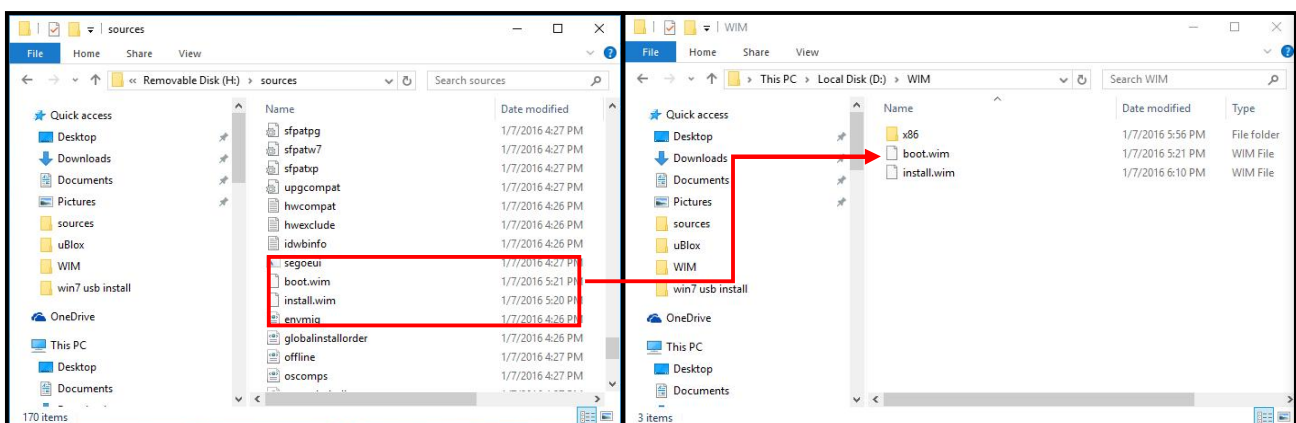

5. Copy the batch file (**Win7_USB3_Patch_x86.bat** or **Win7_USB3_Patch_x64.bat**) to D:\WIM. You can find the batch file in x:\Driver_Pool\USB3_10_Series\Win7_ALL.

Step 4 - Execute batch file to patch .wim files

To support xHCI for Windows 7 installation, both install.wim and boot.wim need to be patched to include xHCI driver files. Neosys offers Windows-based batch files (**Win7_USB3_Patch_x86.bat** for Windows 7 32-bit and **Win7_USB3_Patch_x64.bat** for Windows 7 64-bit) to simplify this process.

1. Before executing the batch file, please make sure folders specified in the batch file are identical to your working folders.

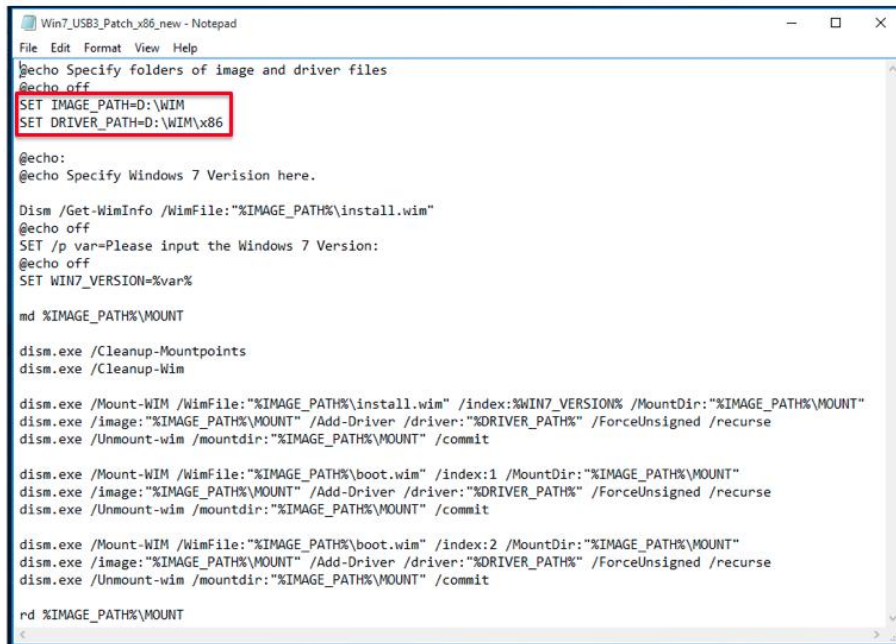

```

Win7_USB3_Patch_x86_new - Notepad
File Edit Format View Help
@echo Specify folders of image and driver files
@echo off
SET IMAGE_PATH=D:\WIM
SET DRIVER_PATH=D:\WIM\x86

@echo:
@echo Specify Windows 7 Verision here.

Dism /Get-WimInfo /WimFile:"%IMAGE_PATH%\install.wim"
@echo off
SET /p var=Please input the Windows 7 Version:
@echo off
SET WIN7_VERSION=%var%

md %IMAGE_PATH%\MOUNT

dism.exe /Cleanup-Mountpoints
dism.exe /Cleanup-Wim

dism.exe /Mount-WIM /WimFile:"%IMAGE_PATH%\install.wim" /index:%WIN7_VERSION% /MountDir:"%IMAGE_PATH%\MOUNT"
dism.exe /image:"%IMAGE_PATH%\MOUNT" /Add-Driver /driver:"%DRIVER_PATH%" /ForceUnsigned /recurse
dism.exe /Unmount-wim /mountdir:"%IMAGE_PATH%\MOUNT" /commit

dism.exe /Mount-WIM /WimFile:"%IMAGE_PATH%\boot.wim" /index:1 /MountDir:"%IMAGE_PATH%\MOUNT"
dism.exe /image:"%IMAGE_PATH%\MOUNT" /Add-Driver /driver:"%DRIVER_PATH%" /ForceUnsigned /recurse
dism.exe /Unmount-wim /mountdir:"%IMAGE_PATH%\MOUNT" /commit

dism.exe /Mount-WIM /WimFile:"%IMAGE_PATH%\boot.wim" /index:2 /MountDir:"%IMAGE_PATH%\MOUNT"
dism.exe /image:"%IMAGE_PATH%\MOUNT" /Add-Driver /driver:"%DRIVER_PATH%" /ForceUnsigned /recurse
dism.exe /Unmount-wim /mountdir:"%IMAGE_PATH%\MOUNT" /commit

rd %IMAGE_PATH%\MOUNT
  
```

2. Execute the batch file with administrator privilege. It appears an interactive menu for choosing Windows 7 edition. Please input the corresponding index number for your Windows 7 edition and press Enter.

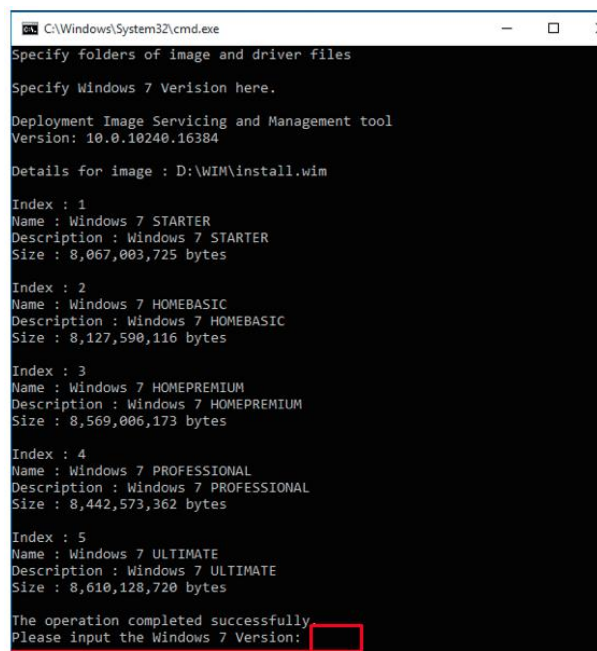

```

C:\Windows\System32\cmd.exe
Specify folders of image and driver files

Specify Windows 7 Verision here.

Deployment Image Servicing and Management tool
Version: 10.0.10240.16384

Details for image : D:\WIM\install.wim

Index : 1
Name : Windows 7 STARTER
Description : Windows 7 STARTER
Size : 8,067,003,725 bytes

Index : 2
Name : Windows 7 HOMEBASIC
Description : Windows 7 HOMEBASIC
Size : 8,127,590,116 bytes

Index : 3
Name : Windows 7 HOMEPREMIUM
Description : Windows 7 HOMEPREMIUM
Size : 8,569,006,173 bytes

Index : 4
Name : Windows 7 PROFESSIONAL
Description : Windows 7 PROFESSIONAL
Size : 8,442,573,362 bytes

Index : 5
Name : Windows 7 ULTIMATE
Description : Windows 7 ULTIMATE
Size : 8,610,128,720 bytes

The operation completed successfully.
Please input the Windows 7 Version:
  
```

3. The batch file will automatically patch both install.wim and boot.wim. It takes few minutes to finish the patch process.
4. Once patch finished, please overwrite the \sources\install.wim and \sources\boot.wim in USB flash drive installer with the patched ones.

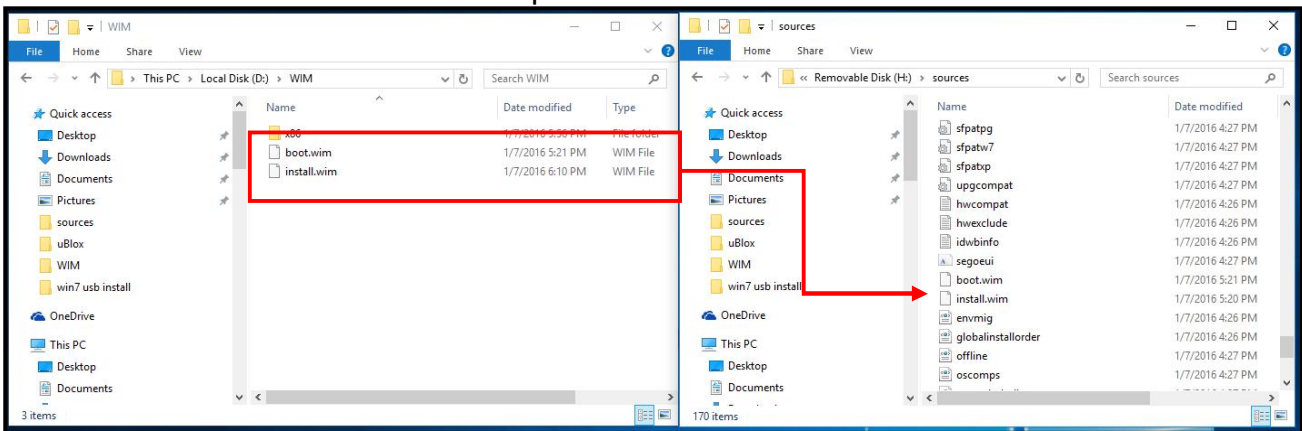

Step 5 - Install Windows 7 using USB flash drive installer

Now you can use the USB flash drive to install Windows 7 on your Nuvo-5095GC.

1. Plug the USB flash drive to USB port of Nuvo-5095GC.
2. Power on the system and press F12 to select USB flash drive as boot device.
3. Follow regular installation process to install Windows 7 on your Nuvo-5095GC. The xHCI driver is included in the newly-installed system.

Note:

If it appears a warning message of “Setup was unable to create a new system partition or locate an existing system partition”, please to unplug and re-plug the USB flash drive, click ‘Refresh’ and try again.

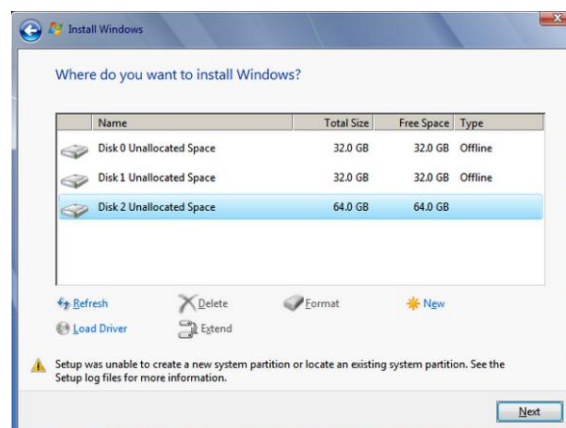

Appendix B Using Watchdog Timer

Nuvo-5095GC series provides watchdog timer (WDT) function to ensure reliable system operation. The WDT is a hardware mechanism to reset the system if the watchdog timer is expired. Users can start the WDT and keeping resetting the timer to make sure the system or program is running. Otherwise, the system shall be reset.

In this section, we'll illustrate how to use the function library provided by Neosys to program the WDT functions. Currently, WDT driver library supports Windows 7/8.1/10 32-bit and 64-bit versions. For other OS support, please contact Neosys Technology for further information.

Install WDT_DIO Library

The WDT_DIO function library is delivered in the form of a setup package named **WDT_DIO_Setup.exe**. In prior to program WDT, you should execute the setup program and install the WDT library. Please use the following WDT_DIO_Setup packages according to your operating systems and applications on Nuvo-5095GC series.

- For Windows 7/8.1/10 32-bit OS, please install WDT_DIO_Setup_v2.2.2.exe or later version.
- For Windows 7/8.1/10 64-bit OS with 64-bit application (x64 mode), please install WDT_DIO_Setup_v2.2.2(x64).exe or later version.
- For Windows 7/8.1/10 64-bit OS with 32-bit application (WOW64 mode), please install WDT_DIO_Setup_v2.2.2(wow64).exe or later version.

To install WDT_DIO_Setup package, please follow steps described below.

1. Execute **WDT_DIO_Setup.2.2.20.exe**. The following dialog appears.

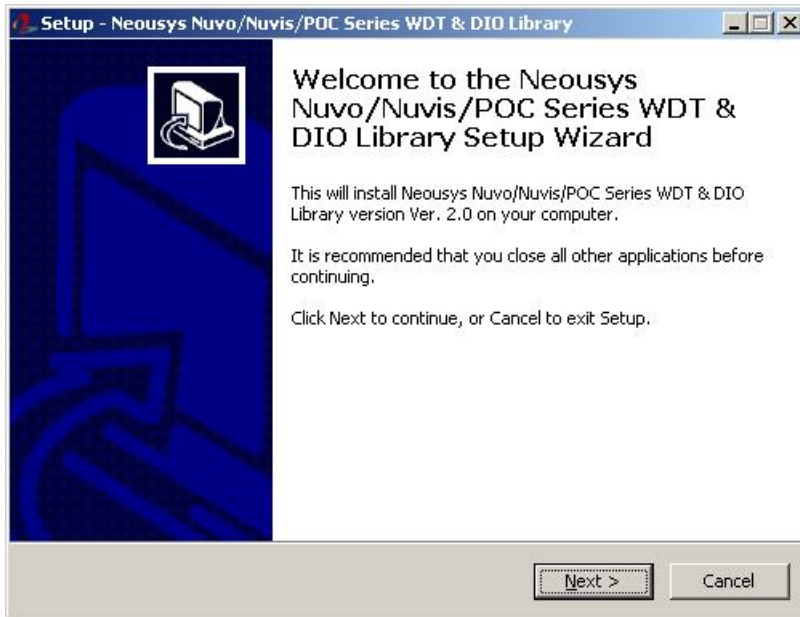

2. Click "Next >" and specify the directory of installing related files. The default directory is *C:\Neosys\WDT_DIO*.

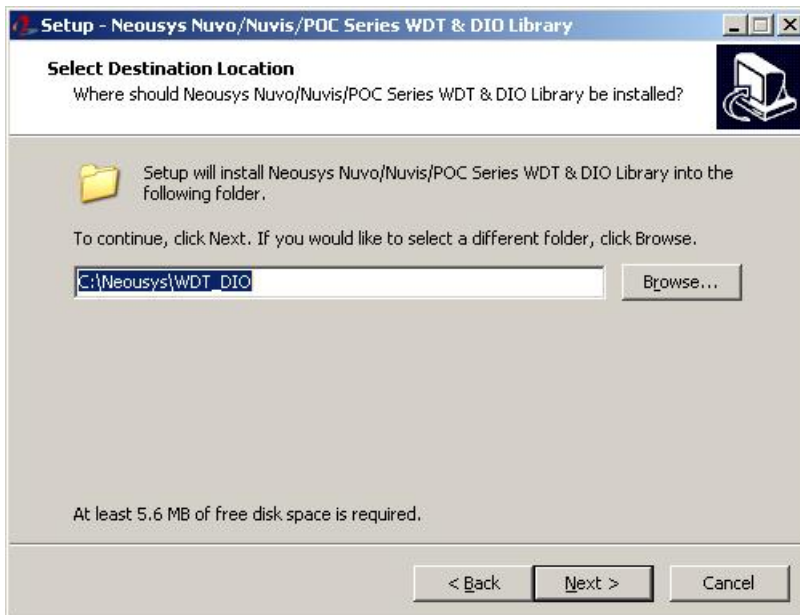

- Once the installation is finished, a dialog appears to prompt you to reboot the system. The WDT & DIO library will take effect after system rebooting.

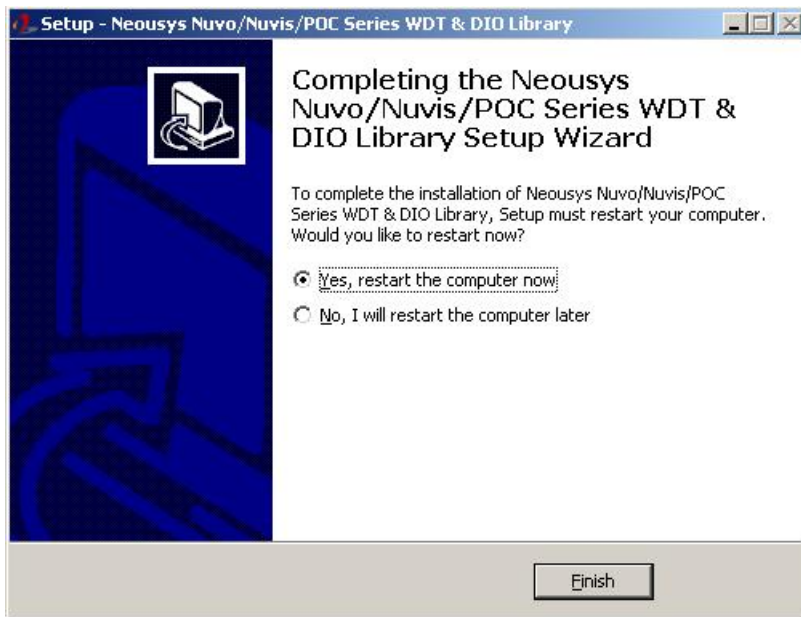

- When you programming your WDT or DIO program, the related files are located in
 - Header file: \Include
 - Lib file: \Lib
 - Function Reference: \Manual
 - Sample Code: \Sample\WDT_Demo (Demo for Watchdog Timer)
\Sample\PoE_Demo (Demo for Per-port PoE Control)

WDT Function Reference

InitWDT

Syntax

```
BOOL InitWDT(void);
```

Description

Initialize the WDT function. You should always invoke InitWDT() before set or start watchdog timer.

Parameter

None

Return Value

Returns TRUE if initialization successes, FALSE if initialization failed.

Usage

```
BOOL bRet = InitWDT();
```

SetWDT

Syntax

```
BOOL SetWDT(WORD tick, BYTE unit);
```

Description

Set timeout value and unit for watchdog timer. When InitWDT() is invoked, a default timeout value of 255 seconds is assigned.

Parameter

tick

WORD value (1 ~ 65535) to indicate timeout ticks.

unit

BYTE value (0 or 1) to indicate unit of timeout ticks.

0 : unit is minute

1: unit is second

Return Value

If value of unit is correct (0 or 1), this function returns TRUE, otherwise FALSE.

Usage

```
WORD tick=255;
```

```
BYTE unit=1; //unit is second.
```

```
BOOL bRet = SetWDT(tick, unit); //timeout value is 255 seconds
```

StartWDT

Syntax

```
BOOL StartWDT(void);
```

Description

Start countdown of WDT. When WDT is started, the WDT LED indicator starts to blink in a frequency of 1Hz. If no ResetWDT() or StopWDT is invoked before WDT is counted to 0, the WDT expires and system resets.

Parameter

None

Return Value

If the timeout value is given in correct format, this function returns TRUE, otherwise FALSE.

Usage

```
BOOL bRet = StartWDT();
```

ResetWDT

Syntax

```
BOOL ResetWDT(void);
```

Description

Reset the timeout value to the value given by SetWDT(). If no ResetWDT() or StopWDT is invoked before WDT is counted to 0, the WDT expires and system resets.

Parameter

None

Return Value

Always returns TRUE;

Usage

```
BOOL bRet = ResetWDT();
```

StopWDT

Syntax

```
BOOL StopWDT(void);
```

Description

Stop the countdown of WDT. When WDT is stopped, the WDT LED indicator stops blinking.

Parameter

None

Return Value



Always returns TRUE;

Usage

BOOL bRet = StopWDT()

