

Neosys Technology Inc.

Nuvo-5000 Series

Intel® 6th-Gen Core™ i7/i5/i3 Fanless Controller

Nuvo-5002E, Nuvo-5006E

Nuvo-5002P, Nuvo-5006P

Nuvo-5002LP, Nuvo-5006LP

Nuvo-5006E-PoE, Nuvo-5006P-PoE, Nuvo-5006LP-PoE

Nuvo-5026E, Nuvo-5026E-PoE

User's Manual

Rev. A3



Revision History

Date	Change List	Version
May. 2016	Initial release	A1
Feb. 2018	Added Nuvo-5026E/ Nuvo-5026E-PoE	A2
Feb. 2019	Updated 5/12VDC power wafer pitch specifications (P.45 / P.46)	A3



Disclaimer.....	- 7 -
Declaration of Conformity	- 7 -
FCC	- 7 -
CE	- 7 -
Copyright and Trademarks	- 7 -
Chapter 1 Introduction	- 8 -
1.1 Overview.....	- 8 -
1.2 Product Specification	- 9 -
1.2.1 Specification of Nuvo-5002E/P and Nuvo-5006E/P	- 9 -
1.2.2 Specification of Nuvo-5002LP and Nuvo-5006LP	- 11 -
1.2.3 Specification of Nuvo-5006E-PoE/5006P-PoE/5006LP-PoE	- 13 -
1.2.4 Specification of Nuvo-5026E/ Nuvo-5026E-PoE.....	- 15 -
1.3 List of Supported CPU	- 17 -
Chapter 2 Getting to Know your Nuvo-5000.....	- 18 -
2.1 Unpacking your Nuvo-5000 Controller.....	- 18 -
2.2 Front Panel I/O Functions.....	- 20 -
2.2.1 Power Button	- 20 -
2.2.2 Reset Button.....	- 21 -
2.2.3 LED Indicators	- 21 -
2.2.4 Gigabit Ethernet Port	- 22 -
2.2.5 Remote On/Off Control and Status LED Output	- 23 -
2.2.6 USB 3.0 Connectors.....	- 24 -
2.2.7 DVI/HDMI Connectors	- 25 -
2.2.8 VGA Connector.....	- 26 -
2.2.9 DisplayPort	- 27 -
2.3 Back Panel I/O Functions	- 28 -
2.3.1 3-Pin Terminal Block for DC and IGN Input	- 28 -
2.3.2 COM Ports (COM1 / COM2 / COM3).....	- 29 -
2.3.3 USB2.0 Connectors.....	- 30 -
2.3.4 Speaker-out and Mic-in Audio Jacks.....	- 30 -
2.3.5 MezIO™ I/O Connector	- 31 -
2.3.6 SIM Socket	- 31 -
2.4 Internal I/O Functions	- 32 -
2.4.1 DDR4 SODIMM Sockets	- 32 -
2.4.2 mSATA / mini-PCIe #1 Dual-Mode Socket.....	- 33 -
2.4.3 Mini-PCIe #2 Socket.....	- 35 -
2.4.4 Internal SATA Port #1	- 37 -
2.4.5 Internal SATA Port #2	- 38 -
2.4.6 Internal USB Port.....	- 39 -



2.5 MezIO™ Interface.....	- 40 -
2.5.1 Pin Definition of MezIO™ Interface.....	- 40 -
2.5.2 MezIO™ Module for Nuvo-5000 Series	- 42 -
2.6 Expansion Cassette.....	- 44 -
2.6.1 Cassette of Nuvo-5006E/5002E	- 45 -
2.6.2 Cassette of Nuvo-5006P/5002P	- 46 -
2.6.3 Cassette of Nuvo-5026E/ Nuvo-5026E-PoE	- 47 -
2.6.3 Neosys Cassette Module.....	- 48 -
2.6.4 Fan in Cassette Enclosure.....	- 49 -
2.7 Mechanical Dimension.....	- 50 -
2.7.1 Top View of Nuvo-5000E/5000P Series	- 50 -
2.7.2 Front View of Nuvo-5000E/5000P Series	- 51 -
2.7.3 Side View of Nuvo-5000E/5000P Series	- 51 -
2.7.4 Bottom View of Nuvo-5000E/5000P Series	- 52 -
2.7.5 Top View of Nuvo-5000LP Series	- 53 -
2.7.6 Front View of Nuvo-5000LP Series.....	- 53 -
2.7.7 Side View of Nuvo-5000LP Series.....	- 54 -
2.7.8 Bottom View of Nuvo-5000LP Series.....	- 54 -
2.7.9 Top View of Nuvo-5026E/ Nuvo-5026E-PoE	- 55 -
2.7.10 Front View of Nuvo-5026E/ Nuvo-5026E-PoE	- 56 -
2.7.11 Rear View of Nuvo-5026E/ Nuvo-5026E-PoE.....	- 56 -
2.7.12 Side View of Nuvo-5026E/ Nuvo-5026E-PoE	- 57 -
2.7.13 Bottom View of Nuvo-5026E/ Nuvo-5026E-PoE	- 57 -
Chapter 3 Getting Start	- 58 -
3.1 Disassemble your Nuvo-5000 Controller	- 58 -
3.1.1 Disassemble Nuvo-5000E/P Series.....	- 58 -
3.1.2 Disassemble Nuvo-5000LP Series	- 60 -
3.2 Install and Replace LGA1151 CPU.....	- 61 -
3.2.1 Identify PCBA Revision.....	- 61 -
3.2.2 Install a CPU on Nuvo-5000 Rev. A1	- 62 -
3.2.3 Replace the CPU on Nuvo-5000 Rev. A1	- 66 -
3.2.4 Install a CPU on Nuvo-5000 Rev. A2	- 69 -
3.2.5 Replace the CPU on Nuvo-5000 Rev. A1	- 73 -
3.3 Install DDR4 SODIMM Module	- 75 -
3.3.1 Install DDR4 SODIMM Module for Nuvo-5000E/P Series.....	- 75 -
3.3.2 Install DDR4 SODIMM Module for Nuvo-5000LP Series	- 76 -
3.4 Install 2.5" SATA HDD/SSD	- 77 -
3.4.1 Install 2.5" SATA HDD/SSD to HDD Bracket.....	- 77 -
3.4.1 Install 2.5" SATA HDD/SSD to HDD Tray (Nuvo-5000LP Only)	- 79 -
3.5 Install Mini-PCIe Module.....	- 80 -



3.6	Install MezIO™ Module.....	- 82 -
3.7	Install Add-on Card in Cassette	- 84 -
3.8	Mount your System.....	- 87 -
3.8.1	Mount your System on the Wall.....	- 87 -
3.8.2	Mount your System on the DIN-rail.....	- 89 -
3.9	Connect DC Power to your System	- 90 -
3.10	Power on your Nuvo-5000 Controller.....	- 91 -
3.10.1	Power on Using the Power Button.....	- 91 -
3.10.2	Power on Using an External Non-latched Switch	- 92 -
3.10.3	Power on Nuvo-5000 Using Wake-on-LAN Function.....	- 93 -
Chapter 4	BIOS and Driver	- 95 -
4.1	BIOS Settings	- 95 -
4.1.1	COM Port Configuration	- 96 -
4.1.2	SATA Port Configuration	- 97 -
4.1.3	Hot Plug for SATA Port #1	- 98 -
4.1.4	Enable TPM Feature.....	- 99 -
4.1.5	Configure CPU SKU Power	- 100 -
4.1.6	Wake-on-LAN Option.....	- 101 -
4.1.7	Power On after Power Failure Option.....	- 102 -
4.1.8	Configure Legacy/UEFI Boot Type	- 103 -
4.1.9	Position New Boot Device	- 104 -
4.1.10	Watchdog Timer for Booting	- 105 -
4.1.11	Select a Boot Device.....	- 107 -
4.2	Configure AMT.....	- 108 -
4.3	Configure RAID Volume.....	- 109 -
4.4	Operating System Support	- 110 -
4.5	Driver Installation	- 111 -
4.5.1	Install All Drivers Using “One-Click” Driver Installation	- 111 -
4.5.2	Install Drivers Manually.....	- 112 -
4.5.3	Install Driver for WDT and Per-port PoE On/Off Control.....	- 114 -
Appendix A	Install Windows 7 on Nuvo-5000.....	- 115 -
A.1	Before We Start	- 115 -
A.2	Create USB Flash Drive Installer Step-by-Step	- 115 -
Step 1	- Create .ISO file from Windows 7 DVD.....	- 115 -
Step 2	- Create USB flash drive installer from .ISO	- 116 -
Step 3	- Create working folder on your local drive	- 117 -
Step 4	- Execute batch file to patch .wim files.....	- 118 -
Step 5	- Install Windows 7 using USB flash drive installer.....	- 119 -
Appendix B	Using Watchdog Timer	- 120 -
Install WDT_DIO Library		- 120 -



WDT Function Reference - 123 -
Appendix C Using Per-Port PoE On/Off Control - 126 -
Per-Port PoE On/Off Control Function Reference - 126 -



Disclaimer

This manual is intended to be used as a practical and informative guide only and is subject to change without prior notice. It does not represent commitment from Neosys Technology Inc. Neosys shall not be liable for direct, indirect, special, incidental, or consequential damages arising out of the use of the product or documentation, nor for any infringements upon the rights of third parties, which may result from such use.

Declaration of Conformity

FCC

This equipment has been tested and found to comply with the limits for a Class A digital device, pursuant to part 15 of the FCC Rules. These limits are designed to provide reasonable protection against harmful interference when the equipment is operated in a commercial environment. This equipment generates, uses, and can radiate radio frequency energy and, if not installed and used in accordance with the instruction manual, may cause harmful interference to radio communications. Operation of this equipment in a residential area is likely to cause harmful interference in which case the user will be required to correct the interference at his own expense.

CE

The product(s) described in this manual complies with all applicable European Union (CE) directives if it has a CE marking. For computer systems to remain CE compliant, only CE-compliant parts may be used. Maintaining CE compliance also requires proper cable and cabling techniques.

Copyright and Trademarks

This document contains proprietary information protected by copyright. All rights are reserved. No part of this document may be reproduced by any mechanical, electronic, or other means in any form without prior written permission of the manufacturer.

Company/product names mentioned herein are used for identification purposes only and are trademarks and/or registered trademarks of their respective companies.



Chapter 1 Introduction

1.1 Overview

Integrating cutting-edge technologies, Neosys creates the next-generation fanless controller, Nuvo-5000 series, with ruggedness, performance and versatility. It supports socket-type, 6th-Gen Core™ processors for flexible CPU selection from Pentium® to Core™ i7 according to performance consideration, and remains -25°C to 70°C true wide-temperature operating.

It provides plenty of embedded I/O functions for general applications, including Gigabit Ethernet, USB3/USB2, COM and VGA/DVI/DP triple display outputs. If they are not enough, Neosys' patented Cassette offers an easy way for I/O expansion by installing an off-the-shelf PCIe/PCI card.

Nuvo-5000 series further incorporates Neosys' MezIO™, an interface electronically and mechanically fitted for embedded system, to presents a cost-effective and reliable way for I/O enhancement. By installing optional MezIO™ module, Nuvo-5000 can deliver more application-oriented functions for diversified vertical markets.

Latest Intel® CPU, Cassette and MezIO™ creates a powerful controller with numerous I/O configuration. Nuvo-5000 is the one platform for all applications!



Nuvo-5000E/P Series



Nuvo-5000LP Series

* R.O.C. Patent No. M456527



1.2 Product Specification

1.2.1 Specification of Nuvo-5002E/P and Nuvo-5006E/P

System Core	
Processor	Supports the following CPU <ul style="list-style-type: none"> - Intel® Core™ i7-6700 (8M Cache, 3.4/4.0 GHz, 65W TDP)* - Intel® Core™ i5-6500 (6M Cache, 3.2/3.6 GHz, 65W TDP)* - Intel® Core™ i3-6100 (3M Cache, 3.7 GHz, 51W TDP)* - Intel® Pentium® G4400 (3M Cache, 3.3 GHz, 54W TDP)* - Intel® Celeron® G3900 (2M Cache, 2.8 GHz, 51TDP)* - Intel® Core™ i7-6700TE (8M Cache, 2.4/3.4 GHz, 35W TDP) - Intel® Core™ i5-6500TE (6M Cache, 2.3/3.3 GHz, 35W TDP) - Intel® Core™ i3-6100TE (4M Cache, 2.7 GHz, 35W TDP) - Intel® Pentium® G4400TE (3M Cache, 2.4 GHz, 35W TDP) - Intel® Celeron® G3900TE (2M Cache, 2.3 GHz, 35W TDP)
Chipset	Intel® Q170 Platform Controller Hub
Graphics	Integrated Intel® HD Graphics 530/510
Memory	Up to 32 GB DDR4-2133 SDRAM by two SODIMM sockets
AMT	Supports AMT 11.0
TPM	Supports TPM 2.0
I/O Interface	
Ethernet	2x Gigabit Ethernet ports by Intel® I219-LM and I210-IT (Nuvo-5002E/P) 6x Gigabit Ethernet ports by Intel® I219-LM and 5x I210-IT (Nuvo-5006E/P)
Video Port	1x stacked VGA + DVI-D connector 2x DisplayPort connectors, supporting 4K2K resolution
USB	4x USB 3.0 ports via native XHCI controller 4x USB 2.0 ports
Serial Port	2x software-programmable RS-232/422/485 ports (COM1 & COM3) 1x RS-232 port (COM2)
Audio	1x Mic-in and 1x Speaker-out
Storage Interface	
SATA HDD	2x Gen3, 6 Gb/s SATA ports for 2.5" HDD/SSD installation, supporting RAID 0/1
mSATA	1x full-size mSATA port (mux with mini-PCIe)
Expansion Bus	
PCI/PCI Express	1x PCI slot in Cassette (Nuvo-5002P/5006P) 1x PCIe x16 slot @ Gen3, 8-lanes signals in Cassette (Nuvo-5002E/5006E)



Mini PCI-E	1x internal mini PCI Express socket with panel-accessible SIM socket 1x internal mini PCI Express socket with internal SIM socket (mux with mSATA)
Expandable I/O	1x MezIO™ expansion port for Neosys' MezIO™ modules
Power Supply & Ignition Control	
DC Input	1x 3-pin pluggable terminal block for 8~35V DC input
Remote Ctrl. & LED Output	1x 10-pin (2x5) wafer connector for remote on/off control and status LED output
Max. Power Consumption	With Core™ i7-6700TE: 49.2W (2.05A@24V)* With Core™ i5-6500TE: 47.8W (1.99A@24V)* With Core™ i3-6100TE: 39.4W (1.64A@24V)*
Mechanical	
Dimension	240 mm (W) x 225 mm (D) x 90 mm (H)
Weight	4.4 kg
Mounting	Wall-mounting (Standard) or DIN-Rail mounting (optional)
Environmental	
Operating Temperature	with i7-6700TE, i5-6500TE, i3-6100TE, Pentium G4400TE (35W TDP) -25°C ~ 70°C *** with i7-6700, i5-6500, i3-6100 (65W/51W TDP) -25°C ~ 70°C **/** (configured as 35W CPU mode) -25°C ~ 50°C **/** (configured as 65W/51W CPU mode)
Storage Temperature	-40°C ~85°C
Humidity	10%~90% , non-condensing
Vibration	Operating, 5 Grms, 5-500 Hz, 3 Axes (w/ SSD, according to IEC60068-2-64)
Shock	Operating, 50 Grms, Half-sine 11 ms Duration (w/ SSD, according to IEC60068-2-27)
EMC	CE/FCC Class A, according to EN 55022 & EN 55024 EN 50155:2007

* Maximal power consumption is measured with 100% CPU and 3D loading applied using Passmark® BurnInTest™ v8.0. No Ethernet connection and external PoE devices are connected. or detail testing criteria, please contact Neosys Technology.

** For i7-6700 running at 65W mode, the high operating temperature shall be limited to 50°C and thermal throttling may occur when sustained full-loading applied. Users can configure CPU power in BIOS to obtain higher operating temperature.

*** For sub-zero operating temperature, a wide temperature HDD drive or Solid State Disk (SSD) is required.



1.2.2 Specification of Nuvo-5002LP and Nuvo-5006LP

System Core	
Processor	Supports the following CPU <ul style="list-style-type: none"> - Intel® Core™ i7-6700 (8M Cache, 3.4/4.0 GHz, 65W TDP)* - Intel® Core™ i5-6500 (6M Cache, 3.2/3.6 GHz, 65W TDP)* - Intel® Core™ i3-6100 (3M Cache, 3.7 GHz, 51W TDP)* - Intel® Pentium® G4400 (3M Cache, 3.3 GHz, 54W TDP)* - Intel® Celeron® G3900 (2M Cache, 2.8 GHz, 51TDP)* - Intel® Core™ i7-6700TE (8M Cache, 2.4/3.4 GHz, 35W TDP) - Intel® Core™ i5-6500TE (6M Cache, 2.3/3.3 GHz, 35W TDP) - Intel® Core™ i3-6100TE (4M Cache, 2.7 GHz, 35W TDP) - Intel® Pentium® G4400TE (3M Cache, 2.4 GHz, 35W TDP) - Intel® Celeron® G3900TE (2M Cache, 2.3 GHz, 35W TDP)
Chipset	Intel® Q170 Platform Controller Hub
Graphics	Integrated Intel® HD Graphics 530/510
Memory	Up to 32 GB DDR4-2133 SDRAM by two SODIMM sockets
AMT	Supports AMT 11.0
TPM	Supports TPM 2.0
I/O Interface	
Ethernet	2x Gigabit Ethernet ports by Intel® I219-LM and I210-IT (Nuvo-5002LP) 6x Gigabit Ethernet ports by Intel® I219-LM and 5x I210-IT (Nuvo-5006LP)
Video Port	1x stacked VGA + DVI-D connector 2x DisplayPort connectors, supporting 4K2K resolution
USB	4x USB 3.0 ports via native XHCI controller 4x USB 2.0 ports
Serial Port	2x software-programmable RS-232/422/485 port (COM1 & COM3) 1x RS-232 port (COM2)
Audio	1x Mic-in and 1x Speaker-out
Storage Interface	
SATA HDD	2x Gen3, 6 Gb/s SATA ports for 2.5" HDD/SSD installation, supporting RAID 0/1
mSATA	1x full-size mSATA port (mux with mini-PCIe)
Expansion Bus	
Mini PCI-E	1x internal mini PCI Express socket with panel-accessible SIM socket 1x internal mini PCI Express socket with internal SIM socket (mux with mSATA)
Expandable I/O	1x MeziO™ expansion port for Neosys' MeziO™ modules
Power Supply & Ignition Control	
DC Input	1x 3-pin pluggable terminal block for 8~35V DC input



Remote Ctrl. & LED Output	1x 10-pin (2x5) wafer connector for remote on/off control and status LED output
Max. Power Consumption	With Core™ i7-6700TE: 49.2W (2.05A@24V)*
	With Core™ i5-6500TE: 47.8W (1.99A@24V)*
	With Core™ i3-6100TE: 39.4W (1.64A@24V)*
Mechanical	
Dimension	240 mm (W) x 225 mm (D) x 77 mm (H)
Weight	3.1 kg
Mounting	Wall-mounting (Standard) or DIN-Rail mounting (optional)
Environmental	
Operating Temperature	with i7-6700TE, i5-6500TE, i3-6100TE, Pentium G4400TE (35W TDP) -25°C ~ 70°C ***
	with i7-6700, i5-6500, i3-6100 (65W/51W TDP) -25°C ~ 70°C **/** (configured as 35W CPU mode)
	-25°C ~ 50°C **/** (configured as 65W/54W/51W CPU mode)
Storage Temperature	-40°C ~85°C
Humidity	10%~90% , non-condensing
Vibration	Operating, 5 Grms, 5-500 Hz, 3 Axes (w/ SSD, according to IEC60068-2-64)
Shock	Operating, 50 Grms, Half-sine 11 ms Duration (w/ SSD, according to IEC60068-2-27)
EMC	CE/FCC Class A, according to EN 55022 & EN 55024 EN 50155:2007

* Maximal power consumption is measured with 100% CPU and 3D loading applied using Passmark® BurnInTest™ v8.0. No Ethernet connection and external PoE devices are connected. or detail testing criteria, please contact Neosys Technology.

** For i7-6700 running at 65W mode, the high operating temperature shall be limited to 50°C and thermal throttling may occur when sustained full-loading applied. Users can configure CPU power in BIOS to obtain higher operating temperature.

*** For sub-zero operating temperature, a wide temperature HDD drive or Solid State Disk (SSD) is required.



1.2.3 Specification of Nuvo-5006E-PoE/5006P-PoE/5006LP-PoE

System Core	
Processor	Support the following CPU <ul style="list-style-type: none"> - Intel® Core™ i7-6700 (8M Cache, 3.4/4.0 GHz, 65W TDP)* - Intel® Core™ i5-6500 (6M Cache, 3.2/3.6 GHz, 65W TDP)* - Intel® Core™ i3-6100 (3M Cache, 3.7 GHz, 51W TDP)* - Intel® Pentium® G4400 (3M Cache, 3.3 GHz, 54W TDP)* - Intel® Celeron® G3900 (2M Cache, 2.8 GHz, 51TDP)* - Intel® Core™ i7-6700TE (8M Cache, 2.4/3.4 GHz, 35W TDP) - Intel® Core™ i5-6500TE (6M Cache, 2.3/3.3 GHz, 35W TDP) - Intel® Core™ i3-6100TE (4M Cache, 2.7 GHz, 35W TDP) - Intel® Pentium® G4400TE (3M Cache, 2.4 GHz, 35W TDP) - Intel® Celeron® G3900TE (2M Cache, 2.3 GHz, 35W TDP)
Chipset	Intel® Q170 Platform Controller Hub
Graphics	Integrated Intel® HD Graphics 530/510
Memory	Up to 32 GB DDR4-2133 SDRAM by two SODIMM sockets
AMT	Supports AMT 11.0
TPM	Supports TPM 2.0
I/O Interface	
Ethernet	6x Gigabit Ethernet ports by Intel® I219-LM and 5x I210-IT
PoE+	IEEE 802.3at PoE+ PSE for Port 3~6, up to 25.5 W each port, 80 W total power budget
Video Port	1x stacked VGA + DVI-D connector 2x DisplayPort connectors, supporting 4K2K resolution
USB	4x USB 3.0 ports via native XHCI controller 4x USB 2.0 ports
Serial Port	2x software-programmable RS-232/422/485 port (COM1 & COM3) 1x RS-232 port (COM2)
Audio	1x Mic-in and 1x Speaker-out
Storage Interface	
SATA HDD	2x Gen3, 6 Gb/s SATA ports for 2.5" HDD/SSD installation, supporting RAID 0/1
mSATA	1x full-size mSATA port (mux with mini-PCIe)
Expansion Bus	
PCI/PCI Express	1x PCI slot in Cassette (Nuvo-5006P-PoE) 1x PCIe x16 slot @ Gen3, 8-lanes PCIE signals in Cassette (Nuvo-5006E-PoE)
Mini PCI-E	1x internal mini PCI Express socket with panel-accessible SIM socket 1x internal mini PCI Express socket with internal SIM socket (mux with mSATA)



Expandable I/O	1x MezIO™ expansion port for Neosys' MezIO™ modules
Power Supply & Ignition Control	
DC Input	1x 3-pin pluggable terminal block for 8~35V DC input
Remote Ctrl. & LED Output	1x 10-pin (2x5) wafer connector for remote on/off control and status LED output
Max. Power Consumption	With Core™ i7-6700TE: 49.2W (2.05A@24V)* With Core™ i5-6500TE: 47.8W (1.99A@24V)* With Core™ i3-6100TE: 39.4W (1.64A@24V)*
Mechanical	
Dimension	240 mm (W) x 225 mm (D) x 90 mm (H) (Nuvo-5006E-PoE / Nuvo-5006P-PoE) 240 mm (W) x 225 mm (D) x 77 mm (H) (Nuvo-5006LP-PoE)
Weight	4.4 kg (Nuvo-5006E-PoE / Nuvo-5006P-PoE) 3.1kg (Nuvo-5006LP-PoE)
Mounting	Wall-mounting (Standard) or DIN-Rail mounting (optional)
Environmental	
Operating Temperature	with i7-6700TE, i5-6500TE, i3-6100TE, Pentium G4400TE (35W TDP) -25°C ~ 70°C *** with i7-6700, i5-6500, i3-6100 (65W/51W TDP) -25°C ~ 70°C **/** (configured as 35W CPU mode) -25°C ~ 50°C **/** (configured as 65W/54W/51W CPU mode)
Storage Temperature	-40°C ~85°C
Humidity	10%~90% , non-condensing
Vibration	Operating, 5 Grms, 5-500 Hz, 3 Axes (w/ SSD, according to IEC60068-2-64)
Shock	Operating, 50 Grms, Half-sine 11 ms Duration (w/ SSD, according to IEC60068-2-27)
EMC	CE/FCC Class A, according to EN 55022 & EN 55024 EN 50155:2007

* Maximal power consumption is measured with 100% CPU and 3D loading applied using Passmark® BurnInTest™ v8.0. No Ethernet connection and external PoE devices are connected. or detail testing criteria, please contact Neosys Technology.

** For i7-6700 running at 65W mode, the high operating temperature shall be limited to 50°C and thermal throttling may occur when sustained full-loading applied. Users can configure CPU power in BIOS to obtain higher operating temperature.

*** For sub-zero operating temperature, a wide temperature HDD drive or Solid State Disk (SSD) is required.



1.2.4 Specification of Nuvo-5026E/ Nuvo-5026E-PoE

System Core	
Processor	Intel® Core™ i7-6700 (8M Cache, 3.4/ 4.0 GHz, 65W TDP)* Intel® Core™ i5-6500 (6M Cache, 3.2/ 3.6 GHz, 65W TDP)* Intel® Core™ i3-6100 (3M Cache, 3.7 GHz, 51W TDP)* Intel® Pentium® G4400 (3M Cache, 3.3 GHz, 54W TDP)* Intel® Celeron® G3900 (2M Cache, 2.8 GHz, 51W TDP)* Intel® Core™ i7-6700TE (8M Cache, 2.4/ 3.4 GHz, 35W TDP) Intel® Core™ i5-6500TE (6M Cache, 2.3/ 3.3 GHz, 35W TDP) Intel® Core™ i3-6100TE (4M Cache, 2.7 GHz, 35W TDP) Intel® Pentium® G4400TE (3M Cache, 2.4 GHz, 35W TDP) Intel® Celeron® G3900TE (2M Cache, 2.3 GHz, 35W TDP)
Chipset	Intel® Q170 platform controller hub
Graphics	Integrated Intel® HD graphics 530 or 510 (CPU dependent)
Memory	Up to 32 GB DDR4-2133 SDRAM by two SODIMM sockets
AMT	Supports AMT 11.0
TPM	Supports TPM 2.0
I/O Interface	
Ethernet	6x Gigabit Ethernet ports by Intel® I219 and 5x I210
PoE+	Optional IEEE 802.3at PoE+ PSE for GbE Ports 3 ~ 6, 80 W total power budget
USB	4x USB3.0 ports via native xHCI controller 4x USB2.0 ports
Video Port	1x stacked VGA + DVI-D connector 2x DisplayPort connectors, supporting 4K2K resolution
Serial Port	2x software-programmable RS-232/ 422/ 485 port (COM1 & COM3) 1x RS-232 port (COM2)
Audio	1x Mic-in and 1x speaker-out
Storage Interface	
SATA HDD	2x internal SATA port for 2.5" HDD/ SSD installation, supporting RAID 0/ 1
mSATA	1x full-size mSATA port (mux with mini-PCIe)
Expansion Bus	
PCI/PCI Express	2x PCIe x8 slot @ Gen3, 4-lanes PCIe signals in expansion Cassette
Mini PCI-E	1x internal mini PCI Express socket with front-accessible SIM socket 1x internal mini PCI Express socket with internal SIM socket (mux with mSATA)
Expandable I/O	1x MezIO™ expansion port for Neosys' MezIO™ modules
Power Supply	



DC Input	1x 3-pin pluggable terminal block for 8~35V DC input
Remote Ctrl. & Status Output	1x 10-pin (2x5) wafer connector for remote on/ off control and status LED output
Mechanical	
Dimension	240 mm (W) x 225 mm (D) x 111 mm (H)
Weight	3.7 kg (incl. CPU, memory and HDD)
Mounting	Wall-mount by mounting bracket (standard) or DIN-Rail mounting (optional)
Environmental	
Operating Temperature	with i7-6700TE, i5-6500TE, i3-6100TE, Pentium G4400TE (35W TDP) -25°C ~ 75°C ** with i7-6700, i5-6500, i3-6100 (65W/51W TDP) -25°C ~ 70°C */ ** (configured as 35W CPU mode) -25°C ~ 50°C */ ** (configured as 65W/ 51W CPU mode)
Storage Temperature	-40°C ~ 85°C
Humidity	10%~90% , non-condensing
Vibration	Operating, 5 Grms, 5-500 Hz, 3 Axes (w/ SSD, according to IEC60068-2-64)
Shock	Operating, 50 Grms, Half-sine 11 ms Duration (w/ SSD, according to IEC60068-2-27)
EMC	CE/ FCC Class A, according to EN55022, EN55024 & EN55032

* For i7-6700 running at 65W mode, the highest operating temperature shall be limited to 50°C and thermal throttling may occur when sustained full-loading applied. Users can configure CPU power in BIOS to obtain higher operating temperature.

** For sub-zero operating temperature, a wide temperature HDD drive or Solid State Disk (SSD) is required.

1.3 List of Supported CPU

Nuvo-5000 series supports Intel® 6th-Gen Core™ i7/i5/i3, Pentium and Celeron processor via the LGA1151 CPU socket. You can choose the following processors according to your consideration of cost and performance.

- **Intel® Core™ i7-6700TE Processor (8M Cache, up to 3.40 GHz, 35W TDP)***
- Intel® Core™ i7-6700T Processor (8M Cache, up to 3.60 GHz, 35W TDP)
- **Intel® Core™ i7-6700 Processor (8M Cache, up to 4.00 GHz, 65W TDP)***
- Intel® Core™ i5-6402P Processor (6M Cache, up to 3.40 GHz, 65W TDP)
- **Intel® Core™ i5-6500TE Processor (6M Cache, up to 3.30 GHz, 35W TDP)***
- Intel® Core™ i5-6600 Processor (6M Cache, up to 3.90 GHz, 65W TDP)
- Intel® Core™ i5-6600T Processor (6M Cache, up to 3.50 GHz, 35W TDP)
- **Intel® Core™ i5-6500 Processor (6M Cache, up to 3.60 GHz, 65W TDP)***
- Intel® Core™ i5-6500T Processor (6M Cache, up to 3.10 GHz, 35W TDP)
- Intel® Core™ i5-6400T Processor (6M Cache, up to 2.80 GHz, 35W TDP)
- Intel® Core™ i5-6400 Processor (6M Cache, up to 3.30 GHz, 65W TDP)
- Intel® Core™ i3-6098P Processor (3M Cache, 3.60 GHz, 54W TDP)
- **Intel® Core™ i3-6100TE Processor (4M Cache, 2.70 GHz, 35W TDP)***
- Intel® Core™ i3-6300 Processor (4M Cache, 3.80 GHz, 51W TDP)
- Intel® Core™ i3-6300T Processor (4M Cache, 3.30 GHz, 35W TDP)
- Intel® Core™ i3-6320 Processor (4M Cache, 3.90 GHz, 51W TDP)
- **Intel® Core™ i3-6100 Processor (3M Cache, 3.70 GHz, 51W TDP)***
- Intel® Core™ i3-6100T Processor (3M Cache, 3.20 GHz, 35W TDP)
- **Intel® Pentium® Processor G4400TE (3M Cache, 2.40 GHz, 35W TDP)***
- Intel® Pentium® Processor G4400T (3M Cache, 2.90 GHz, 35W TDP)
- **Intel® Pentium® Processor G4400 (3M Cache, 3.30 GHz, 54W TDP)***
- Intel® Pentium® Processor G4500 (3M Cache, 3.50 GHz, 51W TDP)
- Intel® Pentium® Processor G4500T (3M Cache, 3.00 GHz, 35W TDP)
- Intel® Pentium® Processor G4520 (3M Cache, 3.60 GHz, 51W TDP)
- **Intel® Celeron® Processor G3900TE (2M Cache, 2.30 GHz, 35W TDP)***
- Intel® Celeron® Processor G3920 (2M Cache, 2.90 GHz, 51W TDP)
- **Intel® Celeron® Processor G3900 (2M Cache, 2.80 GHz, 51W TDP)***

*The processors with * are listed in Intel® Embedded Roadmap and with a 7-year life cycle support (2015~2021).*



Chapter 2 Getting to Know your Nuvo-5000

2.1 Unpacking your Nuvo-5000 Controller

When you receive the package of Nuvo-5000 series, please check immediately if the package contains all the items listed in the following table. If any item is missing or damaged, please contact your local dealer or Neosys Technology Inc. for further assistance.

For Nuvo-5002E/P, 5006E/P, 5006E-PoE and 5006P-PoE

Item	Description	Qty
1	Nuvo-5002E/P, 5006E/P and 5006E/P-PoE fanless controller (According to the configuration you order, CPU/DDR4/HDD may be included. Please verify these items if necessary.)	1
2	Accessory box, which contains <ul style="list-style-type: none"> ● Neosys Drivers & Utilities DVD ● Wall-mounting bracket ● Foot pad ● 3-pin pluggable terminal block ● HDD thermal pad for 2.5" HDD/SSD (if HDD is not installed) ● Screw pack 	1 2 4 1 1 1

For Nuvo-5002LP, 5006LP and 5006LP-PoE

Item	Description	Qty
1	Nuvo-5002LP, 5006LP and 5006LP-PoE fanless controller (According to the configuration you order, CPU/DDR4/HDD may be included. Please verify these items if necessary.)	1
2	Accessory box, which contains <ul style="list-style-type: none"> ● Neosys Drivers & Utilities DVD ● Wall-mounting bracket ● Foot pad ● 3-pin pluggable terminal block ● Key for hot-swappable HDD tray ● HDD thermal pad for 2.5" HDD/SSD (if HDD is not installed) ● Screw pack 	1 2 4 1 1 1 1



For Nuvo-5026E

Item	Description	Qty
1	Nuvo-5026E (If you ordered CPU/ RAM/ HDD, please verify these items)	1
2	Accessory box, which contains <ul style="list-style-type: none"> ● CPU bracket ● Neosys drivers & utilities DVD ● Wall-mounting bracket ● Foot pad ● 3-pin power terminal block ● HDD thermal pad for 2.5" HDD/SSD (if HDD is not installed) ● Screw pack ● Fan (40X40X10 mm) ● Rubber spacer 	1 1 2 4 1 1 1 1 4

2.2 Front Panel I/O Functions

On Nuvo-5000 series, plenty of I/O functions are provided on front panel and back panel so you can easily access them. All models of Nuvo-5000 series share the same I/O allocation and the only difference is the number of Ethernet port. We use Nuvo-5006 as an example for illustrating I/O functions. Most common computer I/O functions are placed on the front panel. In this section, we'll illustrate each I/O function on the front panel.



NOTE

For demonstration purposes, Nuvo-5000 series will be used in most illustrations.

2.2.1 Power Button



The power button is a tact switch for ATX mode on/off operation. To turn on the Nuvo-5000 controller, press the power button and the PWR LED is lighted up. To turn off the Nuvo-5000 controller, you can either issue a shutdown command in OS, or just simply press the power button. In case of system halts, you can press and hold the power button for 5 seconds to compulsorily shut down the system. Please note that a 5 seconds interval is kept by the system between two on/off operations (i.e. once turning off the system, you shall wait for 5 seconds to initiate another power-on operation).

2.2.2 Reset Button



The reset button is used to manually reset the system in case of any abnormal condition. To avoid unexpected operation, the reset button is hidden behind the front panel. You need to use a pin-like object to push the reset button.

2.2.3 LED Indicators



There are four LED indicators on the front panel: PWR, HDD, WDT, and IGN. The descriptions of these three LED are listed in the following table.

Indicator	Color	Description
PWR	Green	Power indicator, lighted-up when system is on.
HDD	Red	Hard drive indicator, flashing when SATA hard drive is active.
WDT	Yellow	Watchdog timer indicator, flashing when watchdog timer is started.
IGN	Orange	If ignition option (MezIO-V20) is applied, this LED is used to indicate ignition signal status.

2.2.4 Gigabit Ethernet Port



Nuvo-5000 series offers 6 GbE ports (Nuvo-5006E/5006P/5006LP) or 2 GbE ports (Nuvo-5002E/5002P/5002LP). The GbE port marked in blue is designed with Intel® I219-LM and ports marked in red are implemented with Intel® I210-IT Gigabit Ethernet controllers. Each port has one dedicated GbE controller and one dedicated PCI Express link to present maximal network performance. When plugging in the Ethernet cable, you can tell the Ethernet status and speed from the LED indicators on the RJ45 connector as following:

Active/Link LED

LED Color	Status	Description
Yellow	Off	Ethernet port is disconnected
	On	Ethernet port is connected and no data transmission
	Flashing	Ethernet port is connected and data is transmitting/receiving

Speed LED

LED Color	Status	Description
Green or Orange	Off	10 Mbps
	Green	100 Mbps
	Orange	1000 Mbps

The port implemented using Intel® I219-LM supports Wake-on-LAN function. It is also capable of operating with Intel® AMT (Active Management Technology) to support advanced features such as remote SOL desktop and remote on/off control. Please refer to section 4.2 for detail.

To utilize the GbE port in Windows, you need to install corresponding driver for Intel® I210-IT/I219-LM GbE controller. Please refer to section 4.5 for information of driver installation.

2.2.5 Remote On/Off Control and Status LED Output

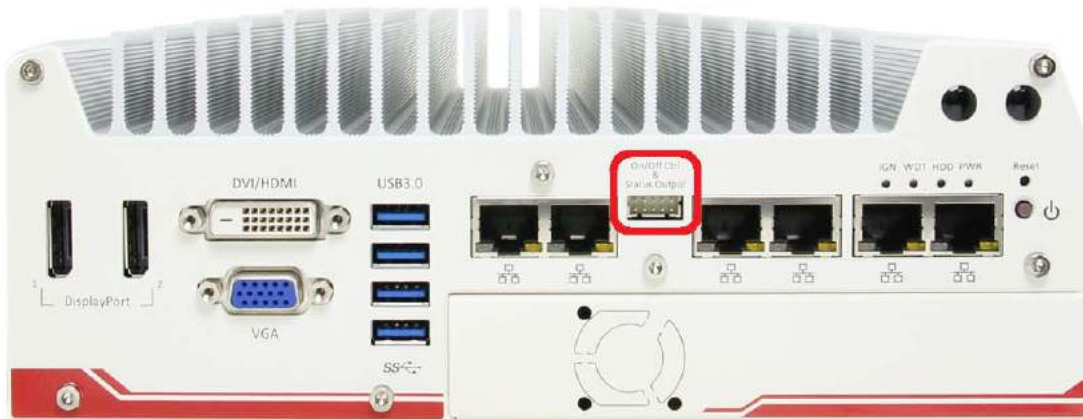

For an application which places Nuvo-5000 controller inside a cabinet, it's useful to control the on/off of the system via an external switch, as well as check how the system's running via some external LED indicators. Nuvo-5000 series provides a 2x5, 2.0mm pitch wafer connector on the front panel for this purpose.

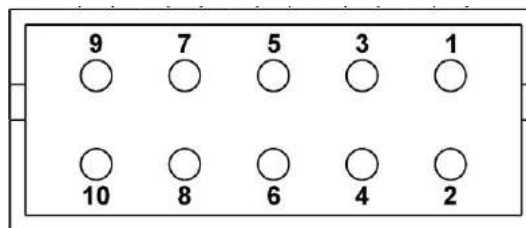

Pin#	Definition	Description
1	Ctrl+	[Input] Remote on/off control, connecting to an external switch to turn on/off the system (polarity is negligible).
2	Ctrl-	
3	Power+	[Output] System power indicator, on if system is turned on, off if system is turned off.
4	Power-	
5	HDD+	[Output] Hard drive indicator, flashing when SATA hard drive is active.
6	HDD-	
7	Standby Power+	[Output] Standby power indicator, lighting up when DC power is applied and system is in S5 (standby) mode.
8	Standby Power-	
9	WDT+	[Output] Watchdog timer indicator, flashing when watchdog timer is started.
10	WDT-	

Note

Please make sure the polarity is correct when you connect the external LED indicator to the Status LED Output.



Pin#3 to pin#10 are used to output the system status including power, HDD, and watchdog timer status. Pin#1 and pin#2 are used to turn on or turn off the system remotely by connecting an external switch. Users should connect a non-latched switch to Ctrl+/Ctrl- as it acts exactly the same as the power button on the front panel. For detail information of using remote on/off control function, please refer to section 3.10.2.

The status LED output has a built-in series-resistor and provides 3.3V, 10mA current, which means you can use these pins to directly drive an external LED indicator.

2.2.6 USB 3.0 Connectors

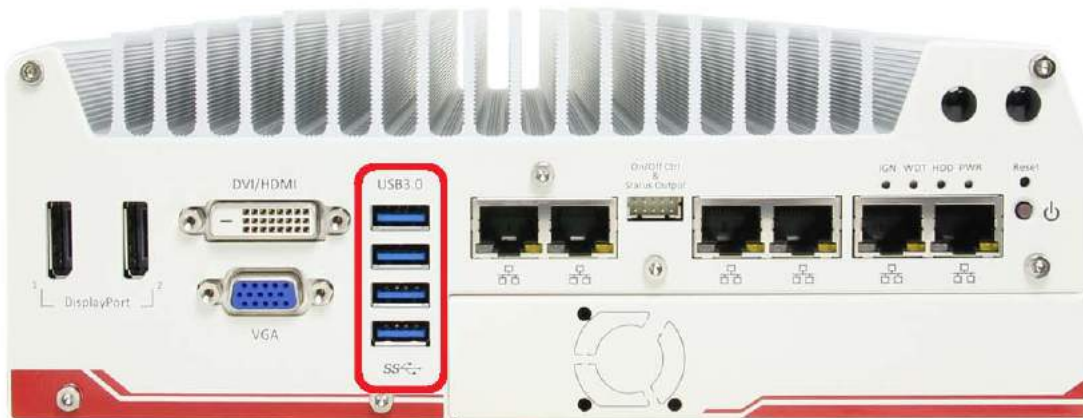

Nuvo-5000 series offers four USB 3.0 (SuperSpeed USB) ports on its front panel. They are implemented by native xHCI (eXtensible Host Controller Interface) controller in Q170 chipset and are compatible with USB 3.0, USB 2.0, USB 1.1 and USB 1.0 devices. Legacy USB support is also provided so you can use USB keyboard/mouse in DOS environment. Due to the nature that XHCI driver is not included natively in Windows 7, you may encounter the issue of USB keyboard/mouse not working when installing Windows 7. Neosys offers a Windows-based batch file and step-by-step guide to help you. Please refer to Appendix A for information of installing Windows 7 on Nuvo-5000 series.

2.2.7 DVI/HDMI Connectors

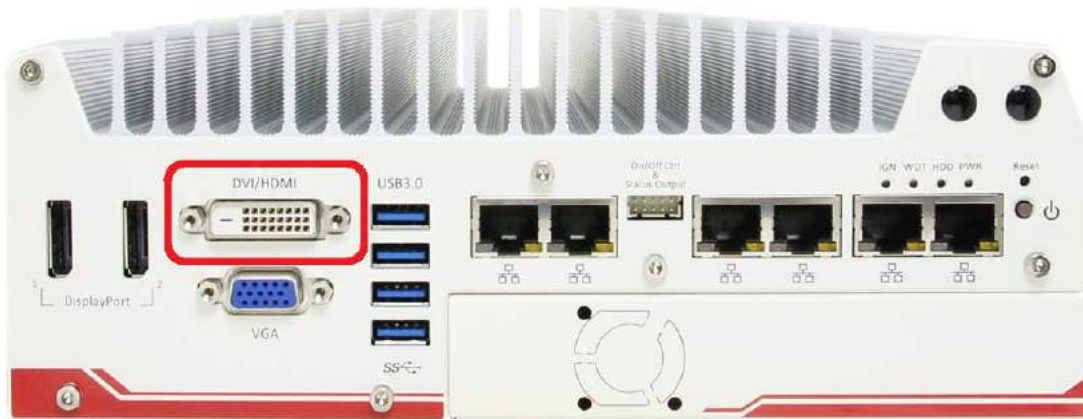

Nuvo-5000 series has multiple display outputs on its front panel for connecting different displays according to your system configuration. DVI/HDMI transmits graphics data in digital format and therefore can deliver better image quality at high resolution. The DVI/HDMI connector on the front panel can either output DVI signals or HDMI signal depending on the display device connected. It supports up to 1920 x 1200 resolution. You can use a DVI to HDMI cable to connect a HDMI display device.



Nuvo-5000 series supports triple independent display outputs with any combination of VGA, DVI/HDMI and DisplayPort. To support multiple display outputs and achieve best DVI/HDMI output resolution in Windows, you need to install corresponding graphics driver. Please refer to section 4.5 for information of driver installation.

2.2.8 VGA Connector



Nuvo-5000 series has multiple display outputs on its front panel for connecting different displays according to your system configuration. VGA connector is the most popular way for connecting a display. The VGA output on Nuvo-5000 series supports up to 1920 x 1200 resolution. By BIOS default and hardware implementation, the VGA output is always enabled in any case.

Nuvo-5000 series supports tiple independent display outputs with any combination of VGA, DVI/HDMI and DisplayPort. To support multiple display outputs and achieve best DVI/HDMI output resolution in Windows, you need to install corresponding graphics driver. Please refer to section 4.5 for information of driver installation.

Note

Please make sure your VGA cable includes SDA and SCL (DDC clock and data) signals for correct communication with monitor to get resolution/timing information. A cable without SDA/SCL can cause blank screen on your VGA monitor due to incorrect resolution/timing output.

2.2.9 DisplayPort



Nuvo-5000 series has multiple display outputs on its front panel for connecting different displays according to your system configuration. Two DisplayPort (DP) connectors are available for high-resolution graphics outputs. They can deliver 4096 x 2304 resolution when single DP port is used or 2880 x 1800 resolution when both DP ports are simultaneously used. DisplayPort on Nuvo-5000 series are designed to support passive DP adapter/cable. You can simply use a DP-to-HDMI cable or DP-to-DVI cable connect different display devices.



Nuvo-5000 series supports triple independent display outputs with any combination of VGA, DVI/HDMI and DisplayPort. To support multiple display outputs and achieve best DVI/HDMI output resolution in Windows, you need to install corresponding graphics driver. Please refer to section 4.5 for information of driver installation.

2.3 Back Panel I/O Functions

To fit general application requirements, Nuvo-5000 series offers more I/O functions on its back panel. In this section, we'll illustrate each I/O function on the back panel.



NOTE

For demonstration purposes, Nuvo-5000 series will be used in most illustrations.

2.3.1 3-Pin Terminal Block for DC and IGN Input



Nuvo-5000 series allows a wide range of DC power input from 8 to 35V via a 3-pin pluggable terminal block, which is fit for field usage where DC power is usually provided. And the screw clamping connection of the terminal block gives a very reliable way of wiring DC power. For detail information of supplying DC power via pluggable terminal block, please refer to section 3.9.

In addition to DC power input, this terminal block can also accept ignition signal input (IGN) when MeziO-V20 ignition control module is installed for in-vehicle applications.

Caution

1. Please make sure the voltage of DC power is correct before you connect it to Nuvo-5000 controller. Supplying a voltage over 35V will damage the system.

2.3.2 COM Ports (COM1 / COM2 / COM3)



Nuvo-5000 series provides three COM ports for communicating with external devices. COM1, COM2 and COM3 are located on the back panel via 9-pin D-Sub male connectors. They are implemented using industrial-grade ITE8786 Super IO chip (-40 to 85°C) and provide up to 115200 bps baud rate.

COM1 and COM3 are software-configurable RS-232/422/485 ports and COM2 is a standard 9-wire RS-232 port. The operation mode, slew rate and termination of COM1 and COM3 can be set in BIOS setup utility (refer to section 4.1.1 for detail). The following table describes the pin definition of COM ports.

	COM1 / COM3			COM2
Pin#	RS-232 Mode	RS-422 Mode	RS-485 Mode (Two-wire 485)	RS-232 Mode
1	DCD			DCD
2	RX	422 TXD+	485 TXD+/RXD+	RX
3	TX	422 RXD+		TX
4	DTR	422 RXD-		DTR
5	GND	GND	GND	GND
6	DSR			DSR
7	RTS			RTS
8	CTS	422 TXD-	485 TXD-/RXD-	CTS
9	RI			RI

2.3.3 USB2.0 Connectors



In addition to USB 3.0, Nuvo-5000 Series provides four USB 2.0 ports on the back panel. They are implemented by native xHCI (eXtensible Host Controller Interface) controller in Q170 chipset and are compatible with USB 2.0, USB 1.1 and USB 1.0 devices. Legacy USB support is also provided so you can use USB keyboard/mouse in DOS environment. Due to the nature that XHCI driver is not natively included in Windows 7, you may encounter the issue of USB keyboard/mouse not working when installing Windows 7. Neosys offers a Windows-based batch file and step-by-step guide to help you. Please refer to Appendix A for information of installing Windows 7 on Nuvo-5000 series.

2.3.4 Speaker-out and Mic-in Audio Jacks



Nuvo-5000 series provides audio function using Intel® High Definition Audio in Q170 chipset and Realtek ALC262 codec. There are two audio jacks on the back panel. The left one is used for microphone input, and the right one is used for speaker output. To utilize the audio function in Windows, you need to install corresponding drivers for both Intel® Q170 chipset and Realtek ALC262 codec. Please refer to section 4.5 for information of driver installation.

2.3.5 MezIO™ I/O Connector



Nuvo-5000 series is designed to incorporate Neusys' MezIO™ interface. You can install a MezIO™ module to expand application-oriented I/O function. To support MezIO™ I/O connectivity, Nuvo-5000 series reserves the cutting hole for a SCSI-II 68-pin connector on its back panel. Please refer to section 2.5 for information of MezIO™ interface and section 3.6 for installing a MezIO™ module.

2.3.6 SIM Socket



Nuvo-5000 series provides a panel-accessible SIM socket is on the back panel. Combining with a 3G/4G module installed on internal mini-PCIe port, you can have Internet access via telecom operator's network. The SIM socket is a push-push type. You can insert and push a SIM card to the end to install it, and push the installed SIM card again to eject it. Please note that SIM card must be inserted upside down. You can refer to section 3.5 for information of installing a 3G/4G module and SIM card.

2.4 Internal I/O Functions

In addition to I/O connectors on the front/back panel, Nuvo-5000 series provides other features via its on-board connectors, such as SATA ports, mini-PCIe sockets, internal USB ports and MezIO™ interface. In this section, we'll illustrate these internal I/O functions.



NOTE

For demonstration purposes, Nuvo-5000 series will be used in most illustrations.

2.4.1 DDR4 SODIMM Sockets

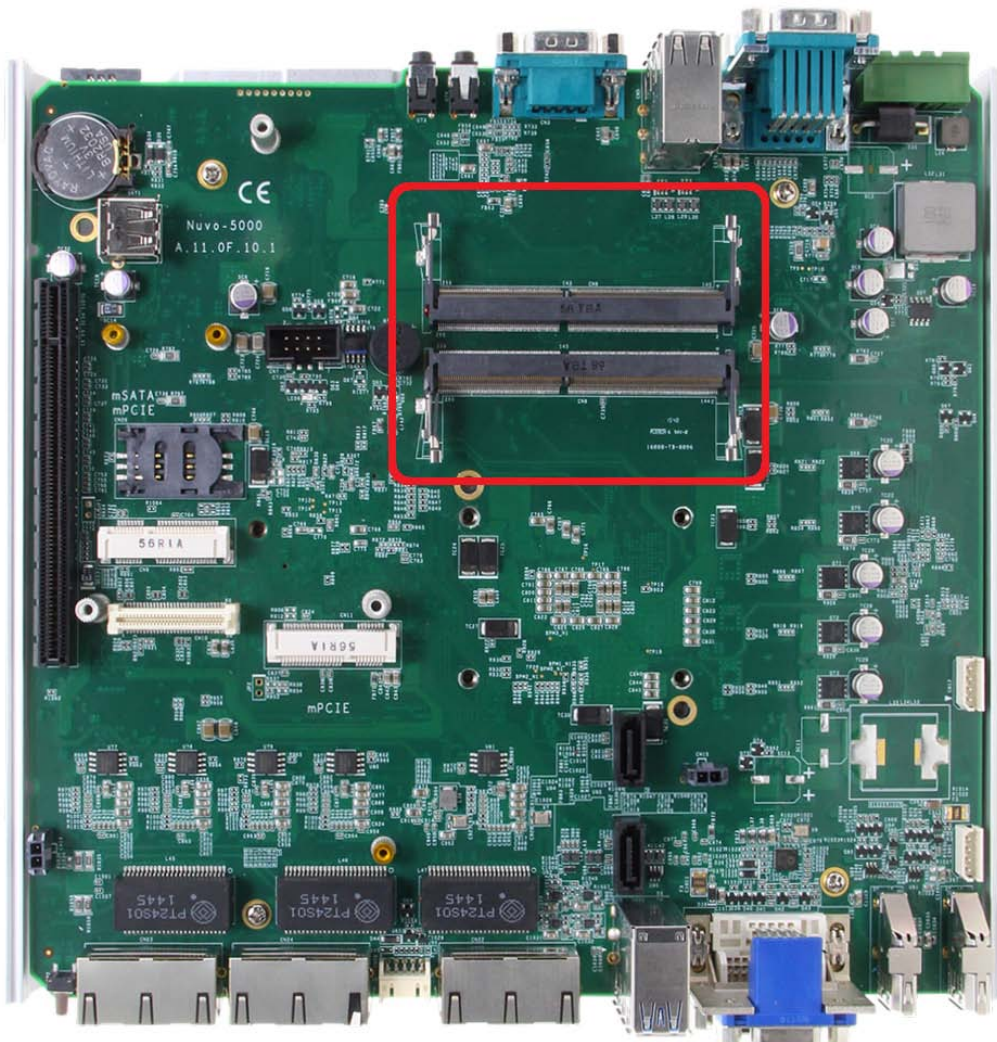

Nuvo-5000 series provides two 260-pin, SODIMM sockets for installing DDR4 memory modules. It supports maximal 32GB capacity by installing two 16GB DDR4 2133 MHz SODIMM modules. For information of installing DDR4 memory modules, please refer to section 3.3 for details.



2.4.2 mSATA / mini-PCle #1 Dual-Mode Socket

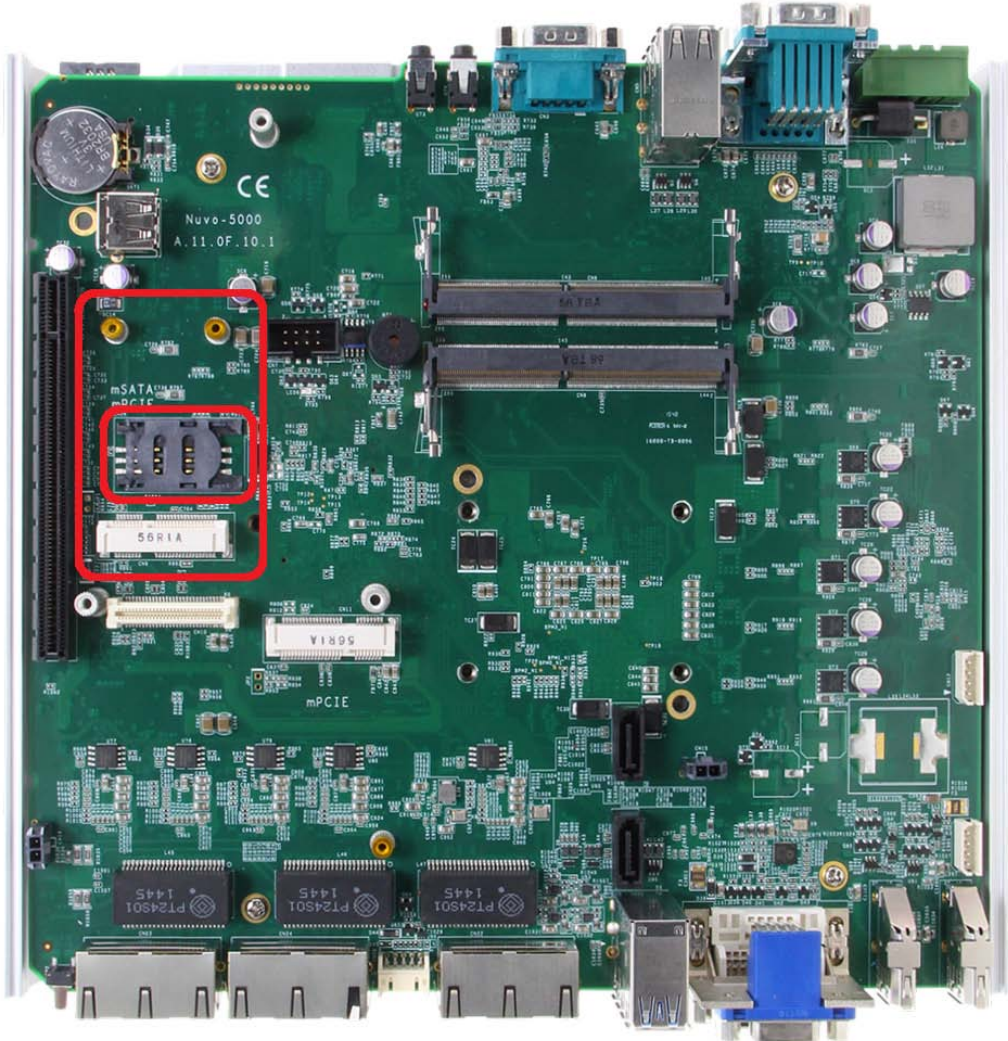

Nuvo-5000 series provides two mini-PCle sockets compliant with mini-PCle specification rev. 1.2. The first socket supports mini-PCle and mSATA dual mode operation. You can install either a mSATA SSD or mini-PCle module into this socket. The system automatically detects and configures it to run PCIe or SATA signals according to installed module. This mini-PCle socket is designed with SIM card support. With a SIM card installed, it's capable to connect your system to Internet in wide territory through telecom 3G/4G network. For WIFI/3G/4G communication, Nuvo-5000 series provides multiple SMA antenna apertures on the front and back panel for multi-antenna configuration.



The following table describes the pin definition of mSATA/mini-PCIe #1 dual-mode socket.

Pin #	Signal (mPCIe)	Signal (mSATA)	Pin #	Signal (mPCIe)	Signal (mSATA)
1	WAKE#	-	2	+3.3Vaux	+3.3Vaux
3	COEX1	-	4	GND	GND
5	COEX2	-	6	+1.5V	+1.5V
7	CLKREQ#	-	8	UIM_PWR	-
9	GND	GND	10	UIM_DATA	-
11	REFCLK-	-	12	UIM_CLK	-
13	REFCLK+	-	14	UIM_RESET	-
15	GND	GND	16	UIM_VPP	-
Mechanical Key					
17	Reserved* (UIM_C8)	-	18	GND	GND
19	Reserved* (UIM_C4)	-	20	W_DISABLE#	-
21	GND	GND	22	PERST#	-
23	PERn0	SATA_Rxp	24	+3.3Vaux	+3.3Vaux
25	PERp0	SATA_Rxn	26	GND	GND
27	GND	GND	28	+1.5V	+1.5V
29	GND	GND	30	SMB_CLK	SMB_CLK
31	PETn0	SATA_Txn	32	SMB_DATA	SMB_DATA
33	PETp0	SATA_Txp	34	GND	GND
35	GND	GND	36	USB_D-	-
37	GND	GND	38	USB_D+	-
39	+3.3Vaux	+3.3Vaux	40	GND	GND
41	+3.3Vaux	+3.3Vaux	42	LED_WWAN#	-
43	GND	-	44	LED_WLAN#	-
45	Reserved	-	46	LED_WPAN#	-
47	Reserved	-	48	+1.5V	+1.5V
49	Reserved	-	50	GND	GND
51	Reserved	-	52	+3.3Vaux	+3.3Vaux

Note

Some off-the-shelf mini-PCIe 4G modules are not compliant to standard mini-PCIe interface. They use 1.8V I/O signals instead of standard 3.3V I/O, and may have signal conflict on certain pins. Please make sure your 4G module has the correct pin definition or consult Neosys for the compatibility. Installing an incompatible 4G module may damage the system or the module itself may be damaged.



2.4.3 Mini-PCle #2 Socket

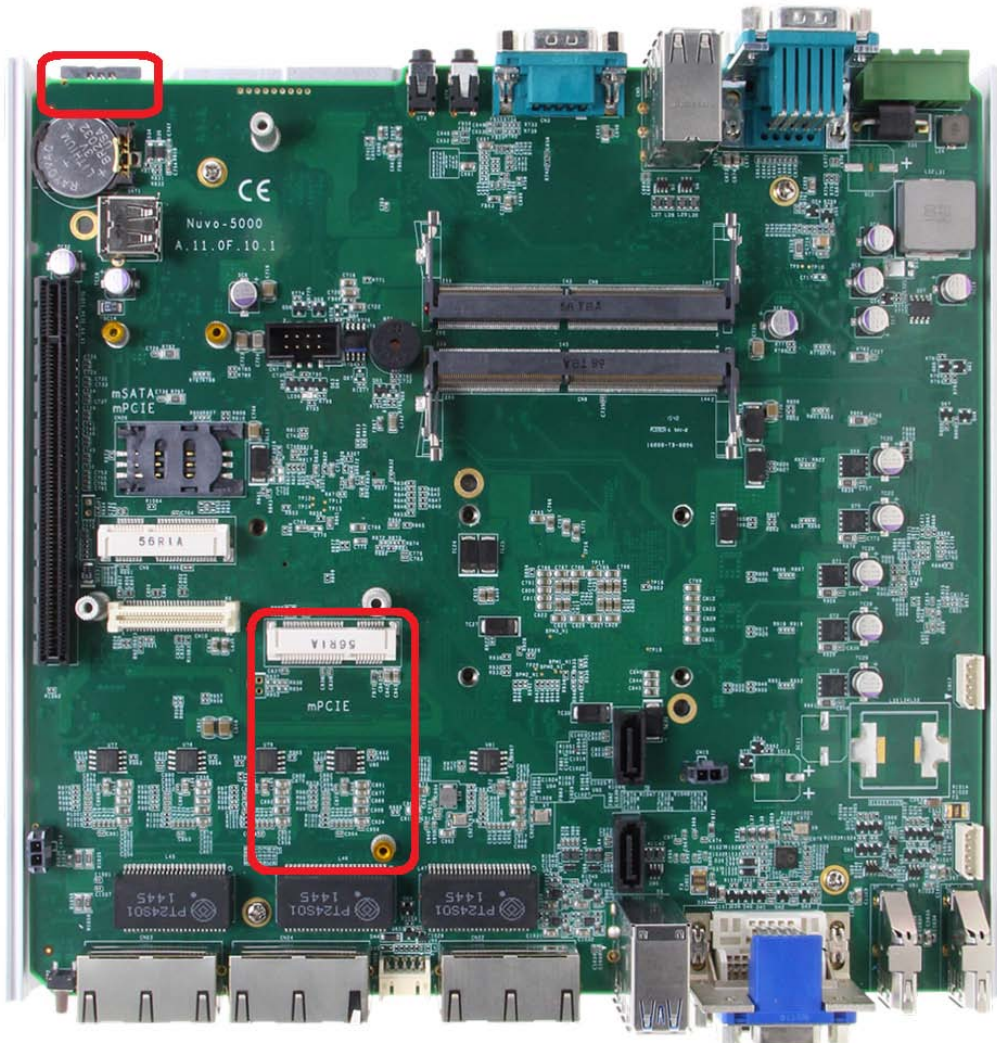

Nuvo-5000 series provides two mini-PCle sockets compliant with mini-PCle specification rev. 1.2. The second mini-PCle socket works with the panel-accessible SIM slot. There are plenty of off-the-shelf mini-PCle modules with versatile capabilities. By installing a mini-PCle module, your system can have expanded features such as WIFI, GPS, CAN bus, analog frame grabber and etc. You can also install a 3G/4G module and SIM card to access Internet in wide territory through telecom 3G/4G network. For WIFI/3G/4G communication, Nuvo-5000 provides multiple SMA antenna apertures on the front and back panel for multi-antenna configuration.



The following table describes the pin definition of mini-PCle #2 socket.

Pin #	Signal	Pin #	Signal
1	WAKE#	2	+3.3Vaux
3	COEX1	4	GND
5	COEX2	6	+1.5V
7	CLKREQ#	8	UIM_PWR
9	GND	10	UIM_DATA
11	REFCLK-	12	UIM_CLK
13	REFCLK+	14	UIM_RESET
15	GND	16	UIM_VPP
Mechanical Key			
17	Reserved* (UIM_C8)	18	GND
19	Reserved* (UIM_C4)	20	W_DISABLE#
21	GND	22	PERST#
23	PERn0	24	+3.3Vaux
25	PERp0	26	GND
27	GND	28	+1.5V
29	GND	30	SMB_CLK
31	PETn0	32	SMB_DATA
33	PETp0	34	GND
35	GND	36	USB_D-
37	GND	38	USB_D+
39	+3.3Vaux	40	GND
41	+3.3Vaux	42	LED_WWAN#
43	GND	44	LED_WLAN#
45	Reserved	46	LED_WPAN#
47	Reserved	48	+1.5V
49	Reserved	50	GND
51	Reserved	52	+3.3Vaux

Note

Some off-the-shelf mini-PCle 4G modules are not compliant to standard mini-PCle interface. They use 1.8V I/O signals instead of standard 3.3V I/O, and may have signal conflict on certain pins. Please make sure your 4G module has the correct pin definition or consult Neousys for the compatibility. Installing an incompatible 4G module may damage the system or the module itself may be damaged.



2.4.4 Internal SATA Port #1

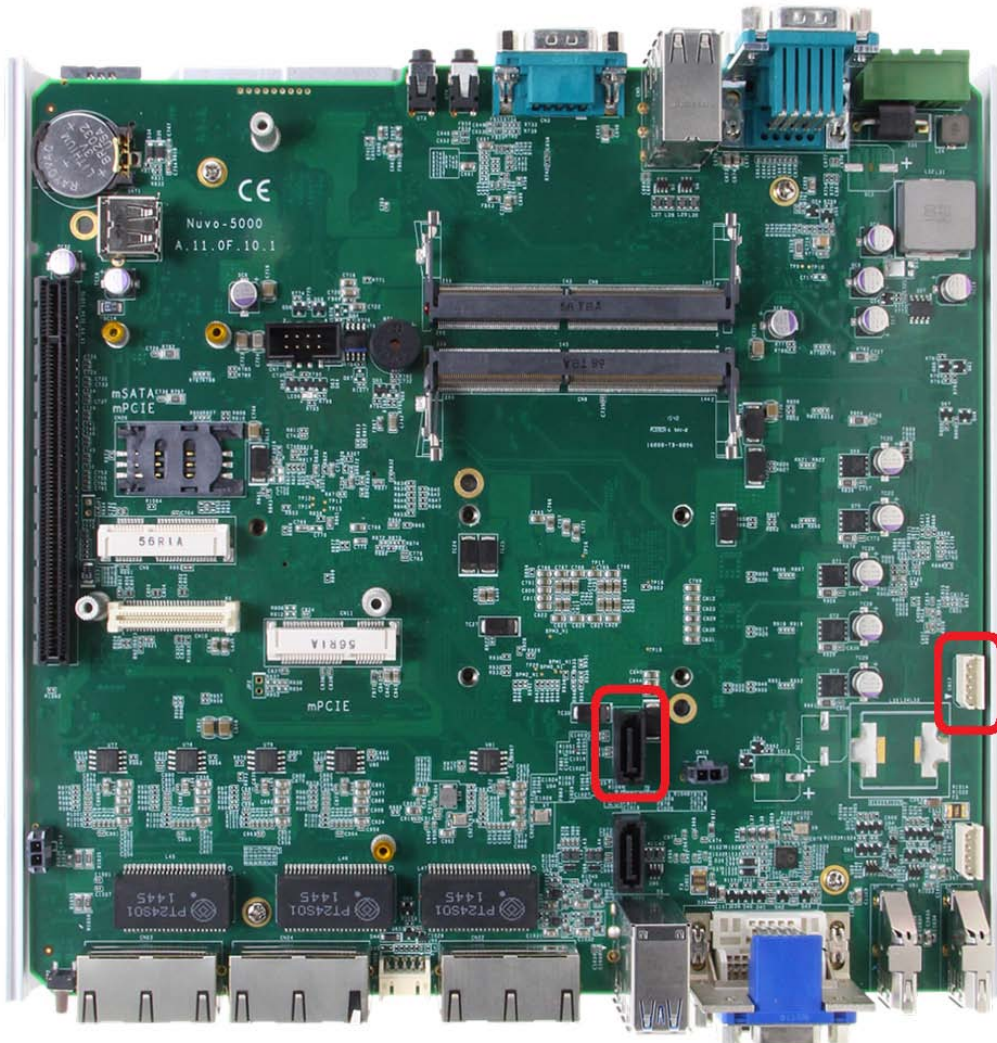

Nuvo-5000 series provides two SATA ports which support Gen3, 6 Gb/s SATA signals. Each SATA port is composed of a 7-pin SATA connector and a 4-pin power connector. In Nuvo-5002E/P and 5006E/P, SATA port #1 is used in conjunction with the HDD bracket to accommodate the first 2.5" HDD/SSD. A dedicated cable is shipped with the system to provide standard 22-pin SATA connector. In Nuvo-5002LP and 5006LP, SATA port #1 is connected to the front-accessible, hot-plug HDD tray so you can easily install and remove a 2.5" HDD/SSD. For information of installing a HDD/SSD to SATA port #1, please refer to section 3.4 for detail.

2.4.5 Internal SATA Port #2

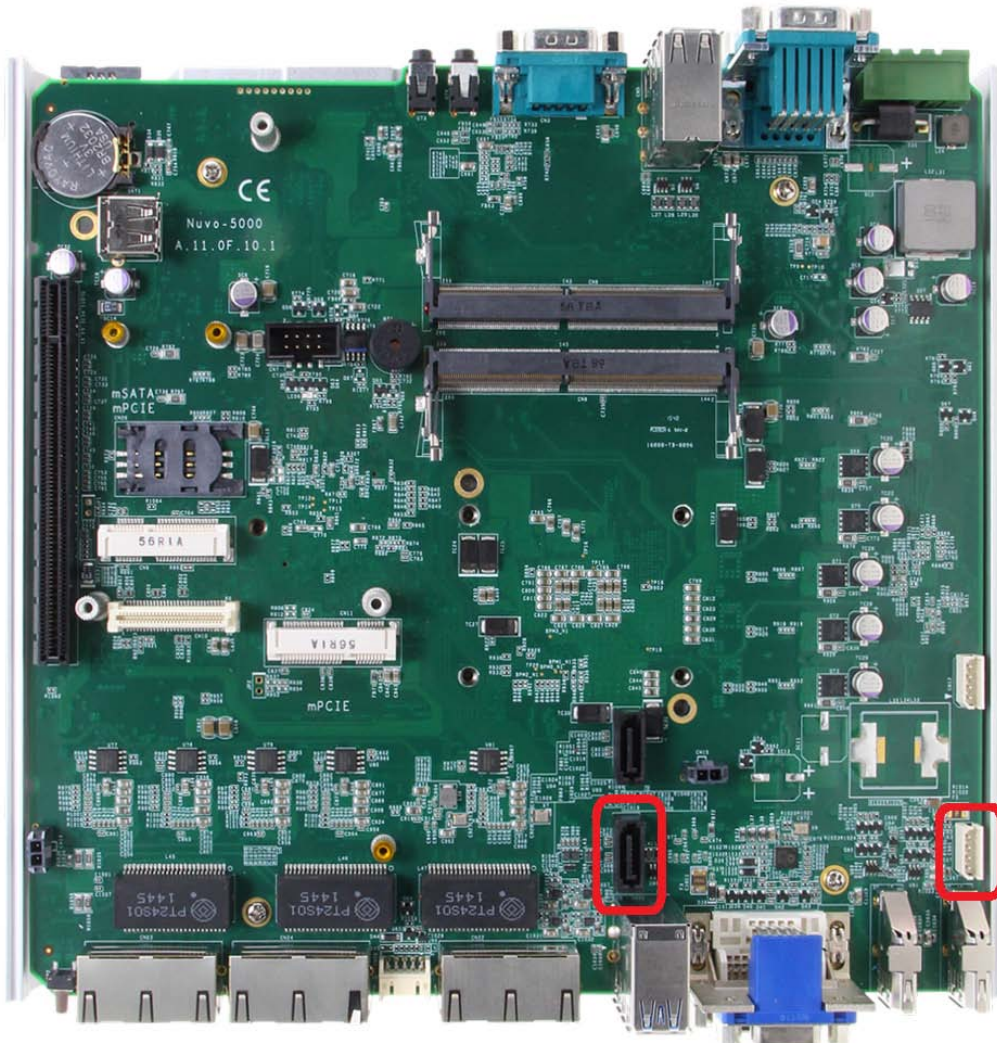

Nuvo-5000 series provides two SATA ports which support Gen3, 6 Gb/s SATA signals. Each SATA port is composed of a 7-pin SATA connector and a 4-pin power connector. For all models of Nuvo-5000 series, SATA port #2 is used in conjunction with the HDD bracket to accommodate the second 2.5" HDD/SSD. A dedicated cable is shipped with the system to provide standard 22-pin SATA connector. For information of installing a HDD/SSD to SATA port #2, please refer to section 3.4 for detail.

2.4.6 Internal USB Port

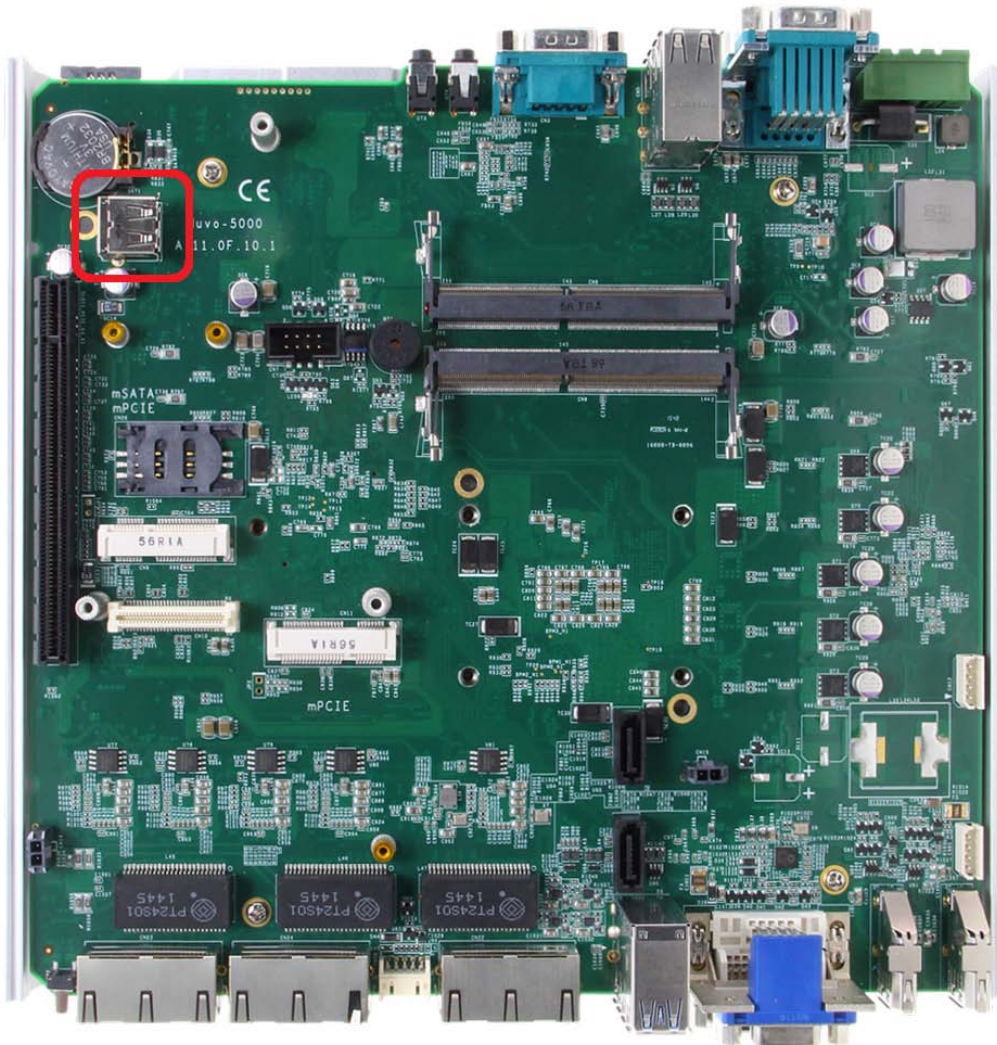

Nuvo-5000 series provides one additional USB port internally on the PCBA. It supports standard USB 2.0 signals. You can utilize this USB port to connect a USB protection dongle inside the chassis of Nuvo-5000 controller.

2.5 MezIO™ Interface

MezIO™ is an innovative interface designed for integrating application-oriented I/O functions into an embedded system. It offers computer signals, power rails and control signals via a high-speed connector. MezIO™ is also mechanically reliable benefited from its 3-point mounted mezzanine structure. A MezIO™ module can leverage these signals to implement comprehensive I/O functions.

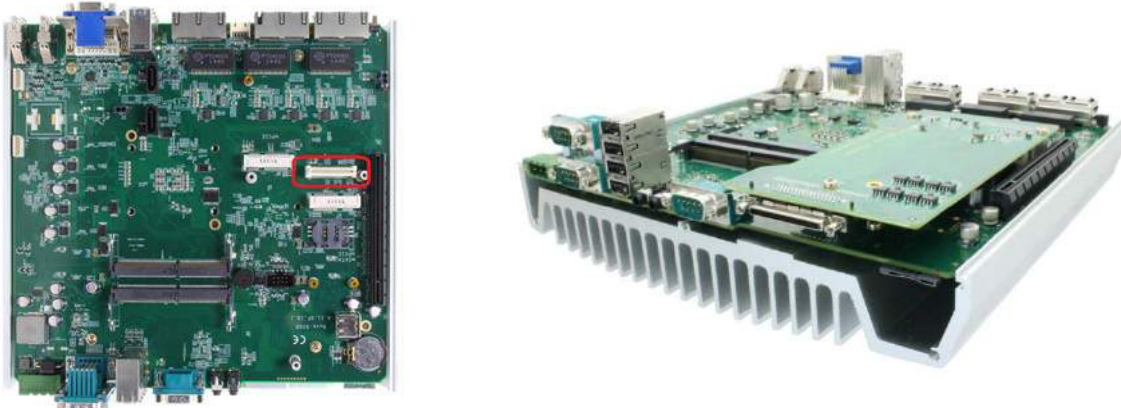

Nuvo-5000 series incorporates MezIO™ interface and universal mechanical design to accommodate Neusys' standard MezIO™ modules. For customers who want to develop their own MezIO™ module, Neusys provides MezIO™ design documents on a NDA basis. Please contact Neusys for further information.

2.5.1 Pin Definition of MezIO™ Interface



MezIO™ interface leverages FCI BERGSTAK® board-to-board connector to provide interconnectivity of high-speed signals. The receptacle part on the PCBA is FCI 61082-063402LF while the plug part on the MezIO™ module is FCI 61083-064402LF. Please refer to the following table for signal definition of its 60-pos connector.



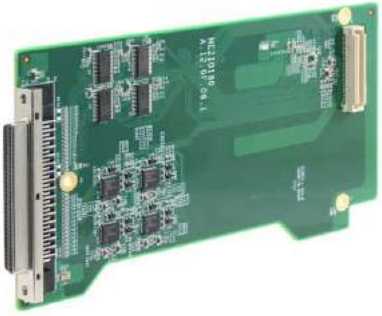

Function Description	Signal	Pin #	Pin #	Signal	Function Description
Reserved	Reserved	1	2	PCIE_TXP_0	PCIe data pair
Reserved	Reserved	3	4	PCIE_TXN_0	PCIe data pair
Reserved	Reserved	5	6	GND	Ground
Reserved	Reserved	7	8	PCIE_RXP_0	PCIe data pair
System S4 signal	SLP_S4#	9	10	PCIE_RXN_0	PCIe data pair
Ground	GND	11	12	CLK100_P_0	PCIe clock pair
Reserved	Reserved	13	14	CLK100_N_0	PCIe clock pair
Ground	GND	15	16	GND	Ground
Reserved	UID_LED	17	18	PCIE_TXP_1	PCIe data pair
Platform reset signal	PLT_RST#	19	20	PCIE_TXN_1	PCIe data pair
USB data pair	USBP5_N	21	22	PCIE_RXP_1	PCIe data pair
USB data pair	USBP5_P	23	24	PCIE_RXN_1	PCIe data pair
Ground	GND	25	26	GND	Ground
SMB bus	SMB_DATA	27	28	CLK100_P_1	PCIe clock pair
SMB bus	SMB_CLK	29	30	CLK100_N_1	PCIe clock pair
PCIe data pair	PCIE_TXP_3	31	32	GND	Ground
PCIe data pair	PCIE_TXN_3	33	34	PCIE_TXP_2	PCIe data pair
Ground	GND	35	36	PCIE_TXN_2	PCIe data pair
PCIe data pair	PCIE_RXP_3	37	38	GND	Ground
PCIe data pair	PCIE_RXN_3	39	40	PCIE_RXP_2	PCIe data pair
Power button signal	PWRBTN#	41	42	PCIE_RXN_2	PCIe data pair
Reserved	Reserved	43	44	RXD4	SIO COM4
PCH GPIO	GPIO_RISER3	45	46	TXD4	SIO COM4
PCH GPIO	GPIO_RISER2	47	48	RXD5	SIO COM5
PCH GPIO	GPIO_RISER1	49	50	TXD5	SIO COM5
Ground	GND	51	52	GND	Ground
3.3V power	P3V3	53	54	P1V8	1.8V power
3.3V power	P3V3	55	56	GND	Ground
5V power	P5V	57	58	P12V	12V power
5V power	P5V	59	60	P12V	12V power

2.5.2 MezIO™ Module for Nuvo-5000 Series

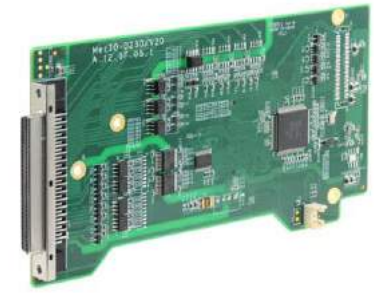
Neosys offers standard MezIO™ modules to expand I/O functions for Nuvo-5000 series. Currently you can have more RS-232/422/485 ports, isolated digital I/O or ignition power control by installing the following module into your Nuvo-5000 controller. Neosys will continuously develop MezIO™ modules with versatile features for Nuvo-5000 series and other embedded products.

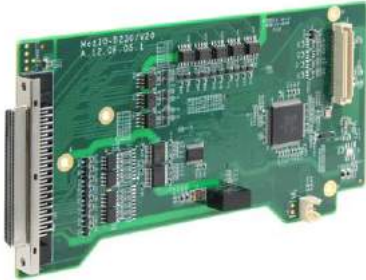
Model	Description	Product Photo
MezIO-C180-50	4-port RS-232/422/485 and 4-port RS-232 MezIO™ module	
MezIO-C181-50	4-port RS-232/422/485 and 4-port RS-422/485 MezIO™ module	
MezIO-D220-50	8-CH isolated DI and 8-CH isolated DO MezIO™ module	

<p>MezIO-D230-50</p>	<p>16-CH isolated DI and 16-CH isolated DO MezIO™ module</p>	 A green printed circuit board (PCB) module for the MezIO-D230-50. It features a multi-pin connector on the left side, a central integrated circuit, and various surface components. The board is populated with numerous electronic components, including resistors and capacitors.
<p>MezIO-V20</p>	<p>16-mode ignition power control MezIO™ module (Nuvo-5000LP only)</p>	 A green printed circuit board (PCB) module for the MezIO-V20. It features a multi-pin connector on the left side, a central integrated circuit, and various surface components. The board is populated with numerous electronic components, including resistors and capacitors.

2.6 Expansion Cassette

Neosys' patented expansion Cassette (R.O.C. Patent No. M456527) is an innovation design for fanless controller. By providing a separated compartment to accommodate add-on card, it's more effective to manage the thermal conditions of both the system and the add-on card. The modular concept brought by Cassette also reduces the complexity of installing and replacing an add-on card in the fanless controller.

Nuvo-5006E/5002E contains a Cassette with PCI Express slot, Nuvo-5006P/5002P contains a Cassette with PCI slot and Nuvo-5026E contains a Cassette that has dual x8 PCI Express slots, each with x4 PCI Express signal. If users want to use an add-on card with higher power consumption, the fan (optional for Nuvo-5000 series, standard accessory for Nuvo-5026E) can create adequate air flow and maintain stable thermal condition for Cassette.



Nuvo-50002E/P and Nuvo-5006E/P



Nuvo-5026E



Note

1. Due to the fanless feature, the total power consumption of installed PCI and PCIe cards should be confined to 16W to limit the heat generated by add-on cards and maintain the system stability. For applications need add-on cards which consume more than 16W, the fan option is suggested to maintain a reasonable temperature inside the chassis. Please refer to section 2.6.4.
2. The operating temperature of the whole system when cards installed is affected by the power consumption and operating temperature of add-on cards. Please consult your add-on card supplier or Neosys Technology for further information.

2.6.1 Cassette of Nuvo-5006E/5002E

The expansion Cassette of Nuvo-5006E/5002E contains a backplane with a x16 PCI Express connector. It runs 8-lanes, Gen3 PCIe signals to provide a maximal 16 GB/s bandwidth. Nuvo-5006E/5002E supports 5A@12V rated current (60 watts) for a PCI Express add-on card with high power consumption. You can also get the 12VDC from the on-board power connectors if necessary.





#	Connector	Function Description										
1	x16 PCI Express	x16 PCI Express connector that runs 8-lane, Gen3 signals. Compatible with x16, x8, x4 and x1 PCI Express add-on card.										
2	12VDC Fan Power	<p>3-pin, 2.54mm pitch power connector for supplying 12VDC to the optional fan.</p>  <table border="1"> <thead> <tr> <th>Pin</th> <th>Description</th> </tr> </thead> <tbody> <tr> <td>1</td> <td>N/A</td> </tr> <tr> <td>2</td> <td>12V (2A rated Current)</td> </tr> <tr> <td>3</td> <td>GND</td> </tr> </tbody> </table>	Pin	Description	1	N/A	2	12V (2A rated Current)	3	GND		
Pin	Description											
1	N/A											
2	12V (2A rated Current)											
3	GND											
3	SATA Signal	Standard 7-pin SATA connector										
4	5/12VDC Power	<p>4-pin, 2.5mm pitch wafer connector for supplying 5/12VDC</p>  <table border="1"> <thead> <tr> <th>Pin</th> <th>Description</th> </tr> </thead> <tbody> <tr> <td>1</td> <td>12V (2A rated Current)</td> </tr> <tr> <td>2</td> <td>GND</td> </tr> <tr> <td>3</td> <td>GND</td> </tr> <tr> <td>4</td> <td>5V (2A rated Current)</td> </tr> </tbody> </table>	Pin	Description	1	12V (2A rated Current)	2	GND	3	GND	4	5V (2A rated Current)
Pin	Description											
1	12V (2A rated Current)											
2	GND											
3	GND											
4	5V (2A rated Current)											

2.6.2 Cassette of Nuvo-5006P/5002P

The expansion Cassette of Nuvo-5006P/5002P contains a backplane with a 32-bit/33MHz PCI connector. Nuvo-5006P/5002P supports 5A@12V rated current (60 watts). You can get the 12VDC from the on-board power connectors if necessary.



#	Connector	Function Description										
1	33MHz/32-bit PCI	33MHz/32-bit PCI bus via PLX8112 PCIe-to-PCI bridge										
2	12VDC Fan Power	3-pin, 2.54mm pitch power connector for supplying 12VDC to the optional fan. <div style="text-align: center;">  </div> <table border="1" style="margin-left: auto; margin-right: auto;"> <thead> <tr> <th>Pin</th> <th>Description</th> </tr> </thead> <tbody> <tr> <td>1</td> <td>N/A</td> </tr> <tr> <td>2</td> <td>12V (2A rated Current)</td> </tr> <tr> <td>3</td> <td>GND</td> </tr> </tbody> </table>	Pin	Description	1	N/A	2	12V (2A rated Current)	3	GND		
Pin	Description											
1	N/A											
2	12V (2A rated Current)											
3	GND											
3	SATA Signal	Standard 7-pin SATA connector										
4	5/12VDC Power	4-pin, 2.5mm pitch wafer connector for supplying 5/12VDC <div style="text-align: center;">  </div> <table border="1" style="margin-left: auto; margin-right: auto;"> <thead> <tr> <th>Pin</th> <th>Description</th> </tr> </thead> <tbody> <tr> <td>1</td> <td>12V (2A rated Current)</td> </tr> <tr> <td>2</td> <td>GND</td> </tr> <tr> <td>3</td> <td>GND</td> </tr> <tr> <td>4</td> <td>5V (2A rated Current)</td> </tr> </tbody> </table>	Pin	Description	1	12V (2A rated Current)	2	GND	3	GND	4	5V (2A rated Current)
Pin	Description											
1	12V (2A rated Current)											
2	GND											
3	GND											
4	5V (2A rated Current)											

2.6.3 Cassette of Nuvo-5026E/ Nuvo-5026E-PoE



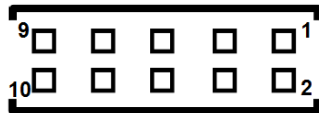

The expansion Cassette of Nuvo-5026E series contains a backplane with two x8 PCI Express slot connectors with x4 PCI Express signal. It supports 7.5A@12V rated current for two PCIe slots. (60 watts Max. power consumption for PCIe slot when paired with a 65W CPU or 90 watts Max. power consumption when paired with a 35W CPU).



#	Connector	Function Description																								
1	x8 PCI Express	Dual x8 PCI Express connector that each runs 4-lane, Gen3 signals. Compatible with x4 and x1 PCI Express add-on card.																								
2	12VDC Fan Power	<p>3-pin, 2.54mm pitch power connector for supplying 12VDC to the fan.</p> <div style="text-align: center;">  </div> <table border="1" style="margin-left: auto; margin-right: auto;"> <thead> <tr> <th>Pin</th> <th>Description</th> </tr> </thead> <tbody> <tr> <td>1</td> <td>N/A</td> </tr> <tr> <td>2</td> <td>12V (2A rated Current)</td> </tr> <tr> <td>3</td> <td>GND</td> </tr> </tbody> </table>	Pin	Description	1	N/A	2	12V (2A rated Current)	3	GND																
Pin	Description																									
1	N/A																									
2	12V (2A rated Current)																									
3	GND																									
3	7.5/12VDC Power	<p>10-pin, 2.0mm pitch wafer connector for Industrial-grade Intelligent Ultracapacitor-based power backup module (PB2500J).</p> <div style="text-align: center;">  </div> <table border="1" style="margin-left: auto; margin-right: auto;"> <thead> <tr> <th>Pin</th> <th>Description</th> <th>Pin</th> <th>Description</th> </tr> </thead> <tbody> <tr> <td>1</td> <td>PWRBTNJ_SLOT</td> <td>2</td> <td>SLP_S4_S5_n_SLOT</td> </tr> <tr> <td>3</td> <td>BAT_MONITOR1</td> <td>4</td> <td>SLP_S3_n_SLOT</td> </tr> <tr> <td>5</td> <td>-</td> <td>6</td> <td>-</td> </tr> <tr> <td>7</td> <td>-</td> <td>8</td> <td>-</td> </tr> <tr> <td>9</td> <td>GND</td> <td>10</td> <td>GND</td> </tr> </tbody> </table>	Pin	Description	Pin	Description	1	PWRBTNJ_SLOT	2	SLP_S4_S5_n_SLOT	3	BAT_MONITOR1	4	SLP_S3_n_SLOT	5	-	6	-	7	-	8	-	9	GND	10	GND
Pin	Description	Pin	Description																							
1	PWRBTNJ_SLOT	2	SLP_S4_S5_n_SLOT																							
3	BAT_MONITOR1	4	SLP_S3_n_SLOT																							
5	-	6	-																							
7	-	8	-																							
9	GND	10	GND																							

2.6.3 Neusys Cassette Module

Neusys offers several read-to-use Cassette modules with pre-installed functional card and cautiously-designed thermal solution. You can simply install a Cassette module to Nuvo-5000 series to obtain additional function without concerning any thermal issue.

Model	Description	Product Photo
CSM-R800	Cassette module with 4-drives hardware RAID 0/1/10, accommodating four 2.5" SATA HDD/SSD	
CSM-PoE354	Cassette module with PCIe-PoE354at and pre-installed passive heat-spreader	
CSM-USB380	Cassette module with PCIe-USB380 and pre-installed passive heat-spreader	
CSM-NV750	Cassette module with nVidia GTX-750 graphics card, pre-installed heat-spreader and fan	

2.6.4 Fan in Cassette Enclosure

When an add-on card with high power consumption (e.g. PCIe graphics card) installed in Cassette, you need to consider the thermal dissipation. Neousys offers a fan (optional accessory for Nuvo-5000 series, standard for Nuvo-5026E series) as a general solution for versatile add-on cards, to create active air flow and maintain proper temperature inside Cassette. If conduction-cooling scheme is needed, a customized a heat-spreader shall be made accordingly to contact components on add-on card and the surface of Cassette.

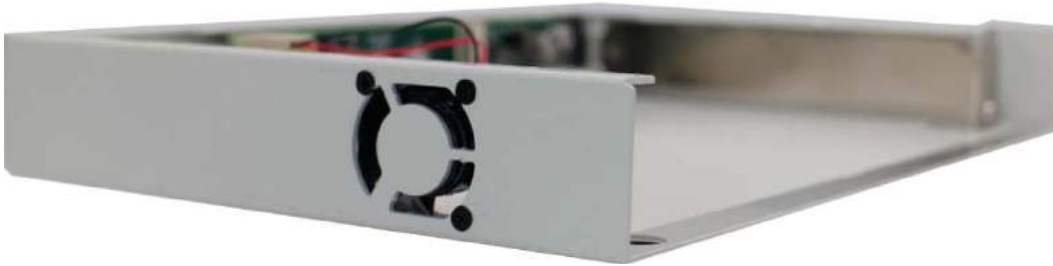

Nuvo-5000 series Cassette fan (optional)



Nuvo-5026E series Cassette fan



2.7 Mechanical Dimension

2.7.1 Top View of Nuvo-5000E/5000P Series

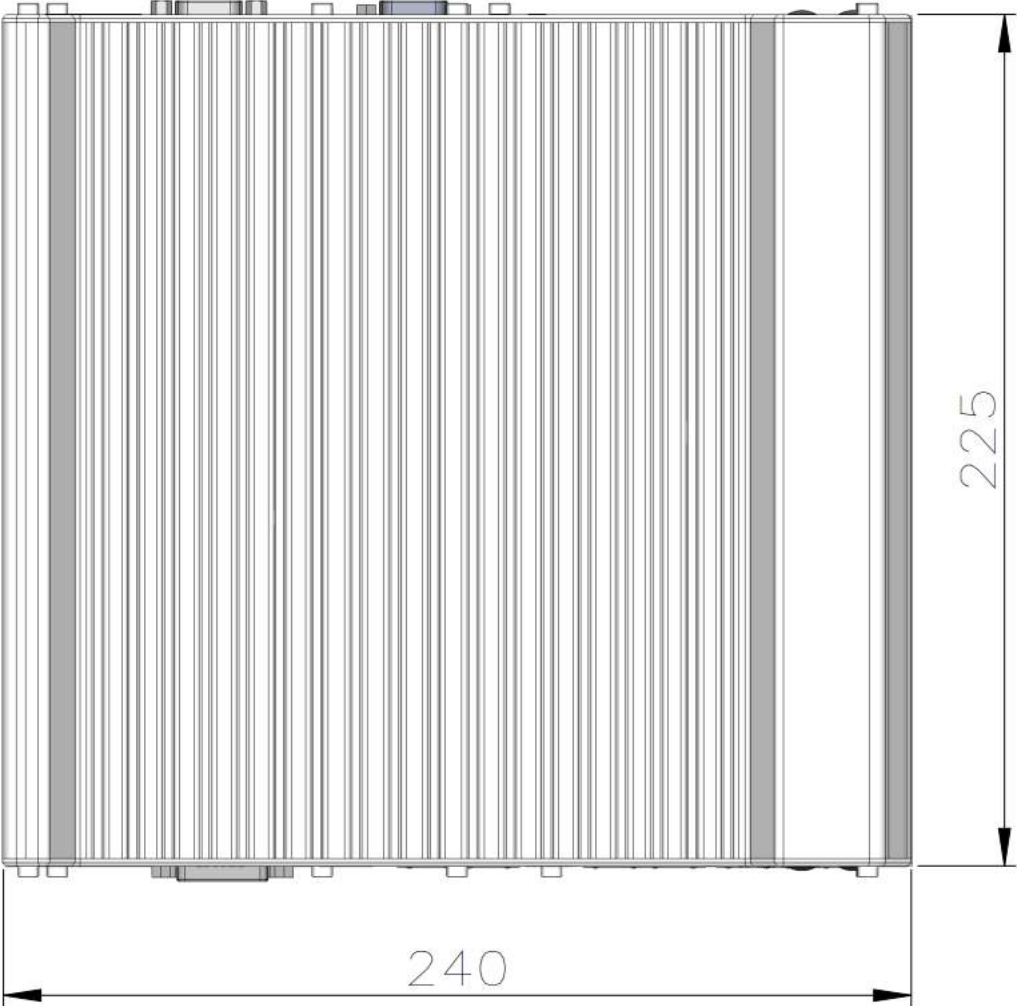

2.7.2 Front View of Nuvo-5000E/5000P Series

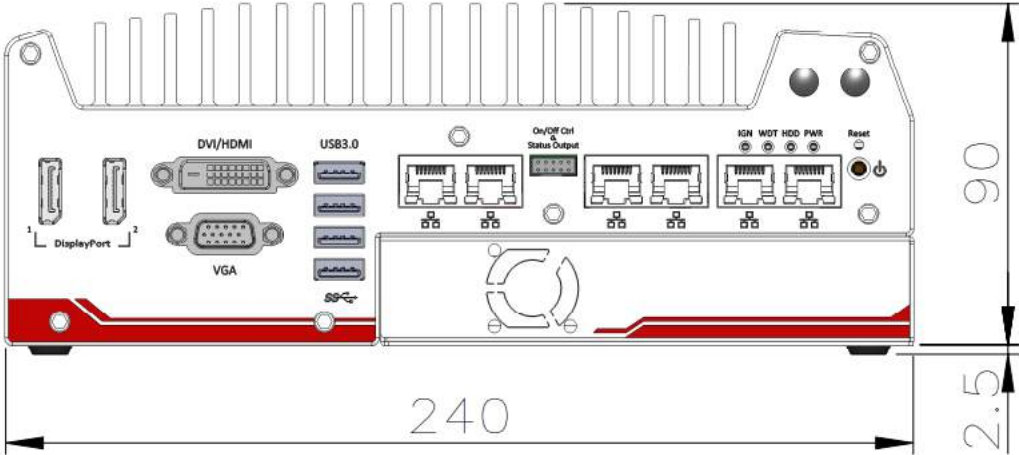

2.7.3 Side View of Nuvo-5000E/5000P Series

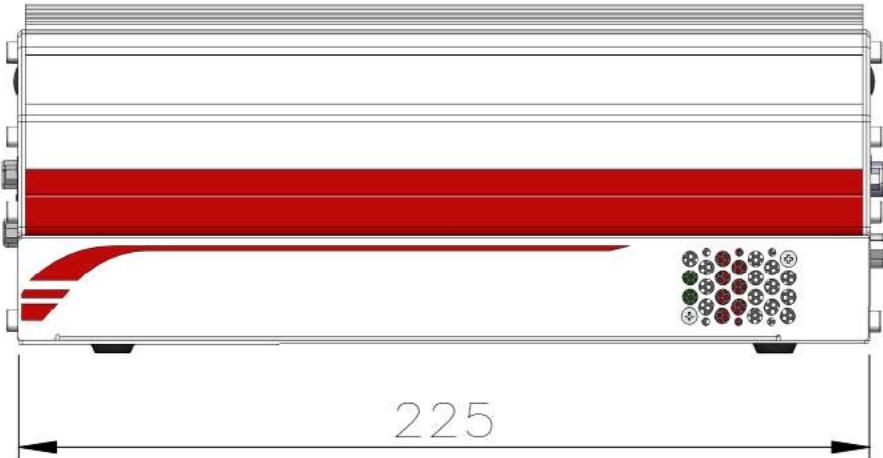

2.7.4 Bottom View of Nuvo-5000E/5000P Series

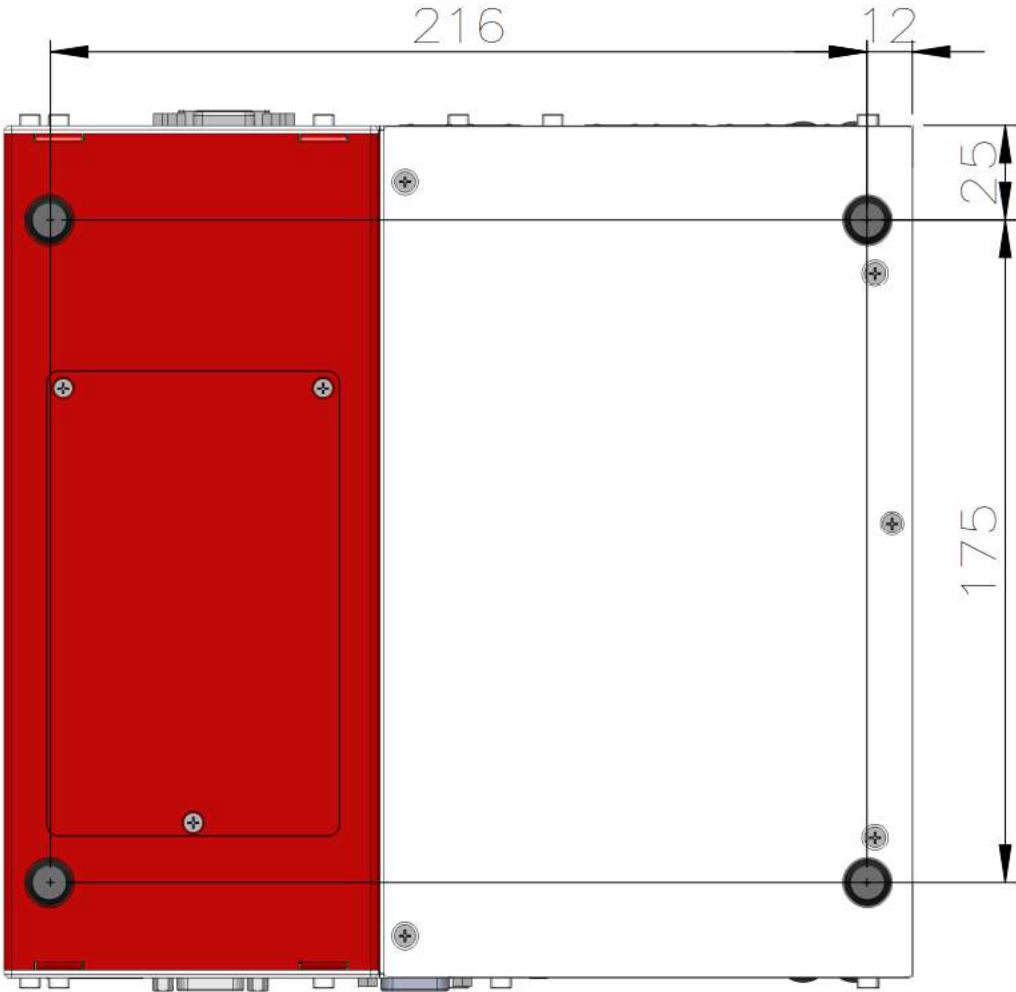

2.7.5 Top View of Nuvo-5000LP Series

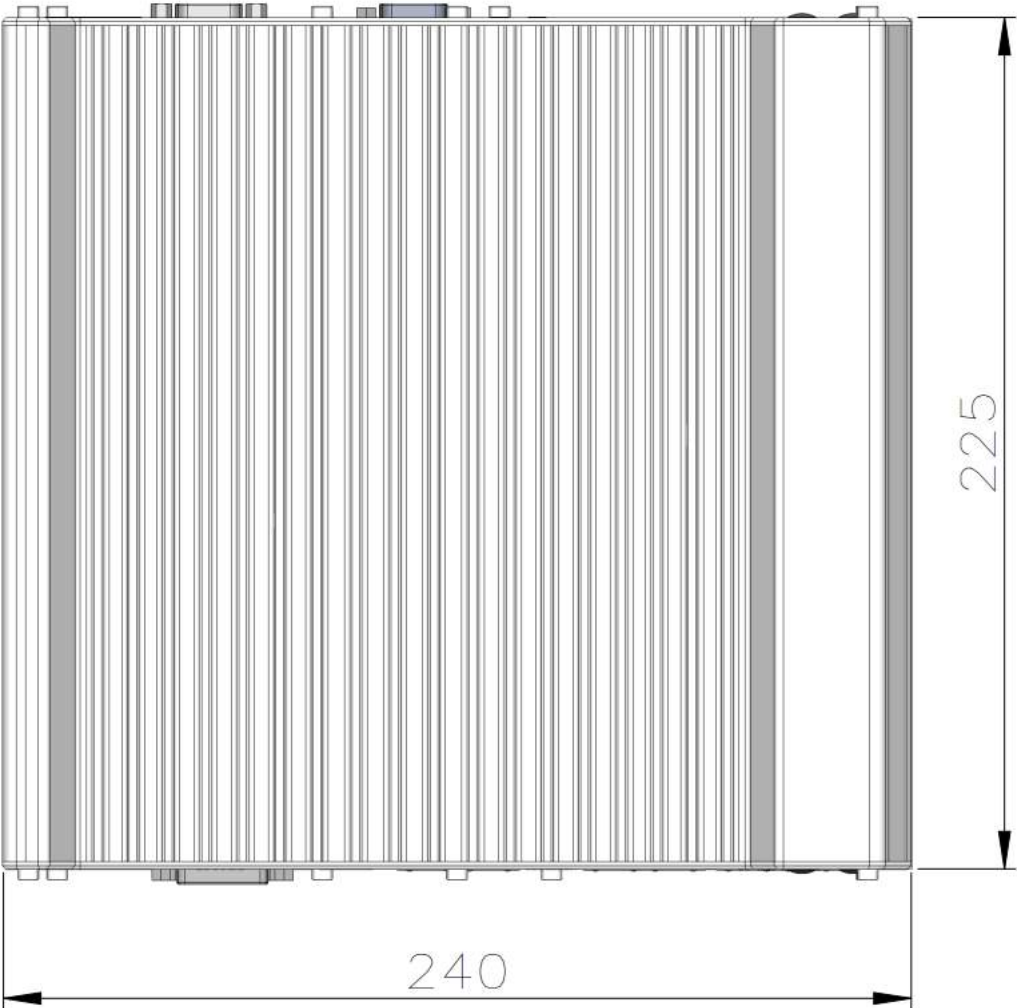

2.7.6 Front View of Nuvo-5000LP Series

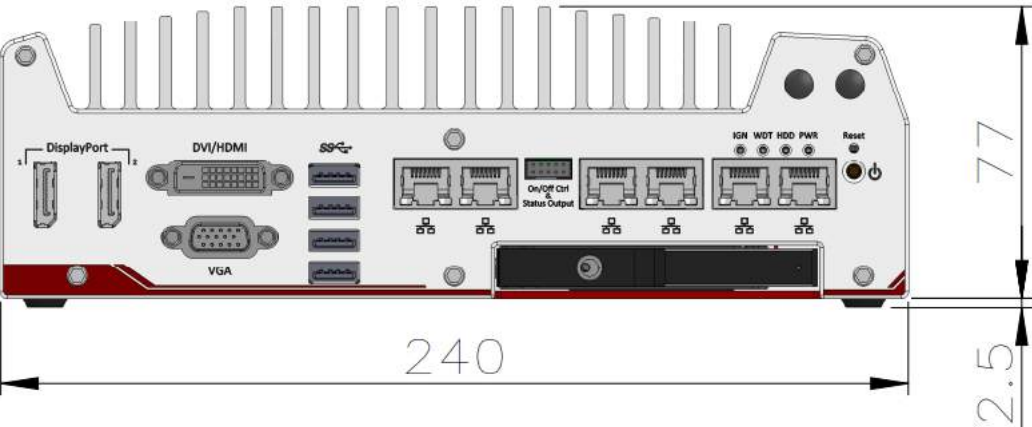

2.7.7 Side View of Nuvo-5000LP Series

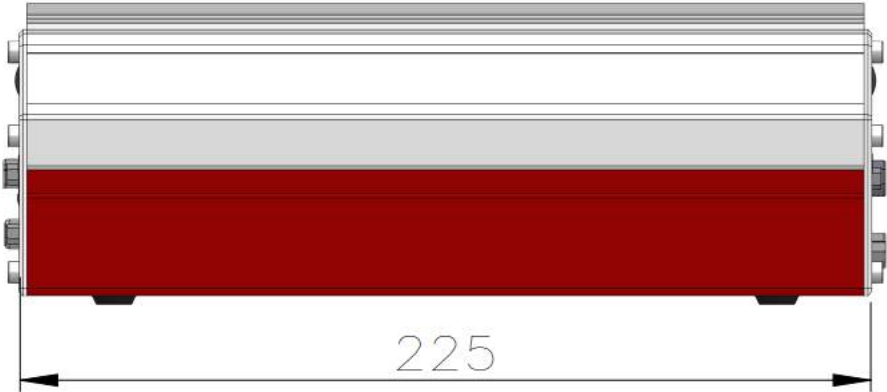

2.7.8 Bottom View of Nuvo-5000LP Series

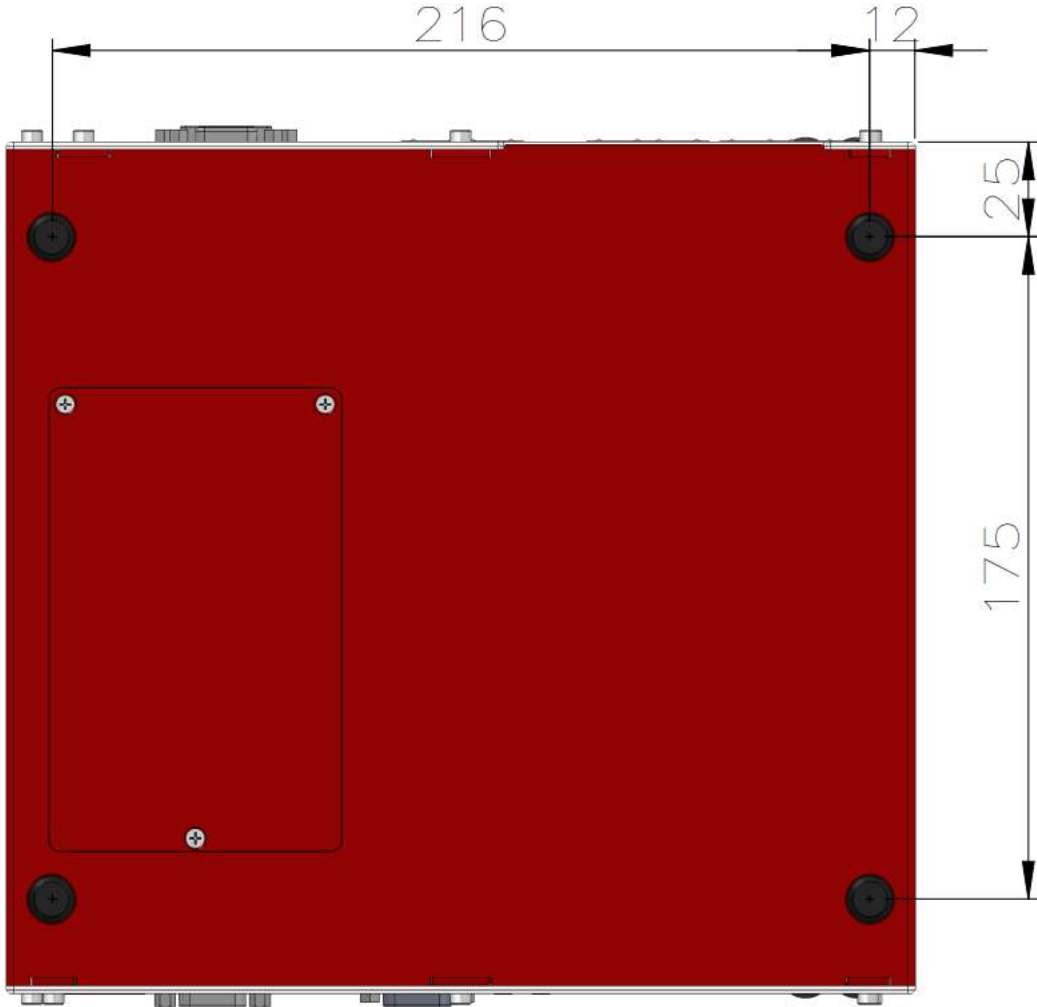

2.7.9 Top View of Nuvo-5026E/ Nuvo-5026E-PoE

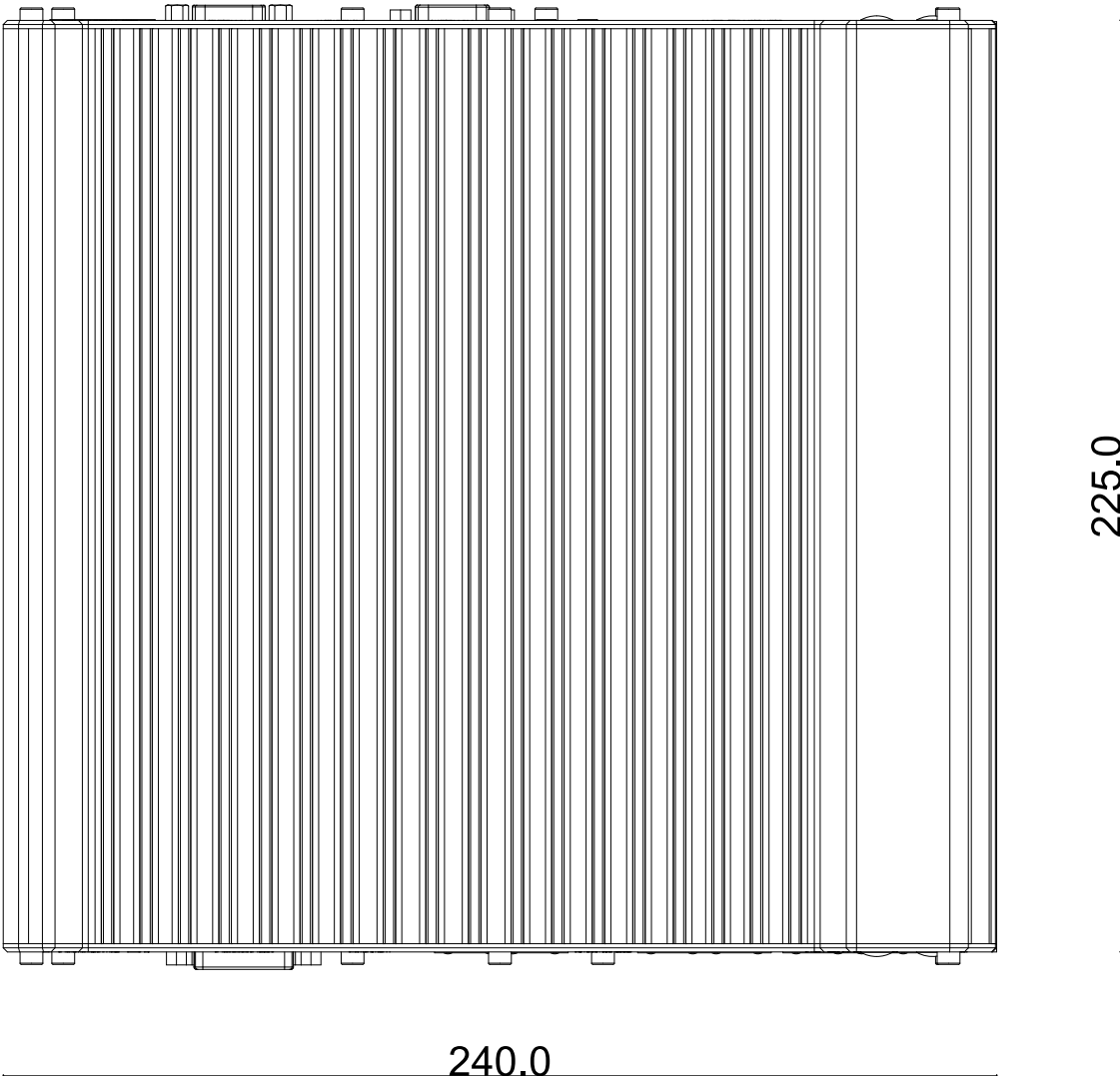

2.7.10 Front View of Nuvo-5026E/ Nuvo-5026E-PoE

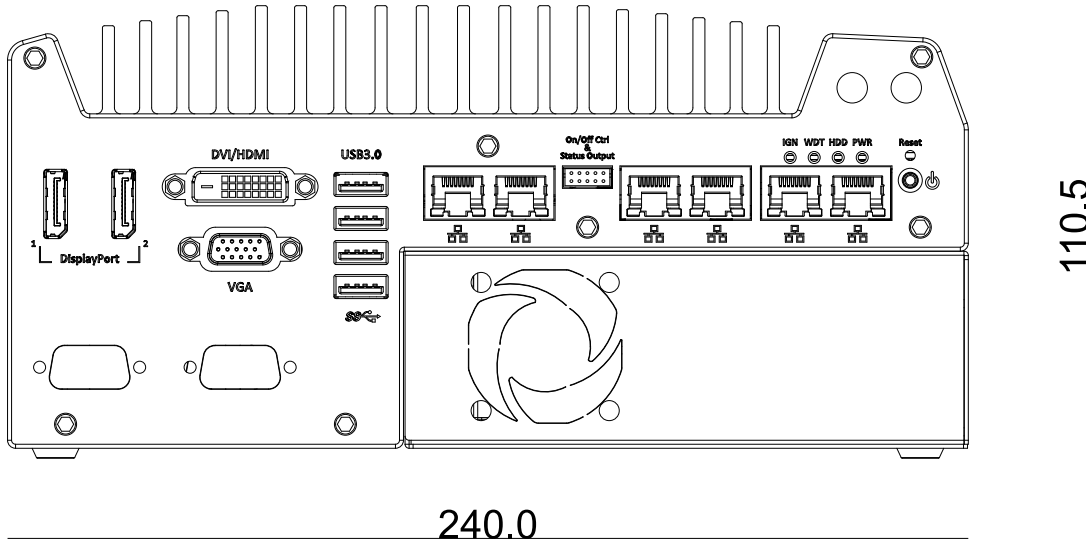

2.7.11 Rear View of Nuvo-5026E/ Nuvo-5026E-PoE

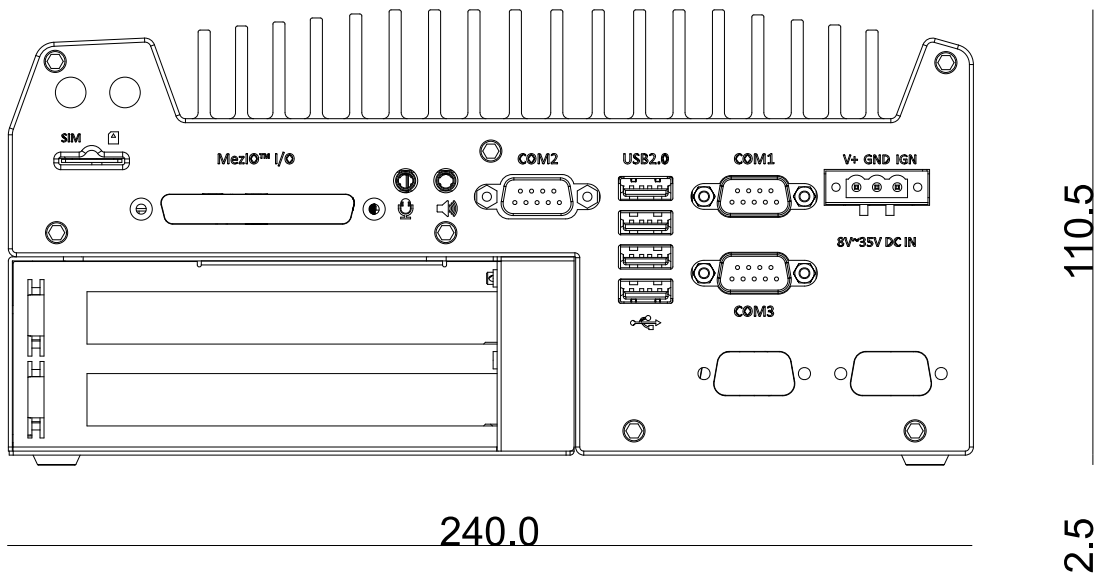

2.7.12 Side View of Nuvo-5026E/ Nuvo-5026E-PoE

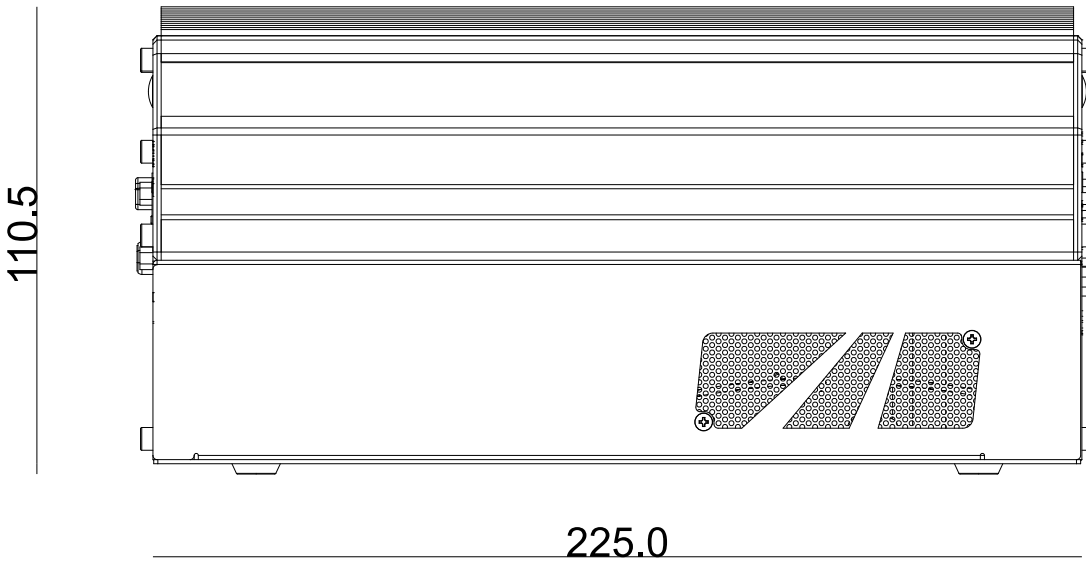

2.7.13 Bottom View of Nuvo-5026E/ Nuvo-5026E-PoE

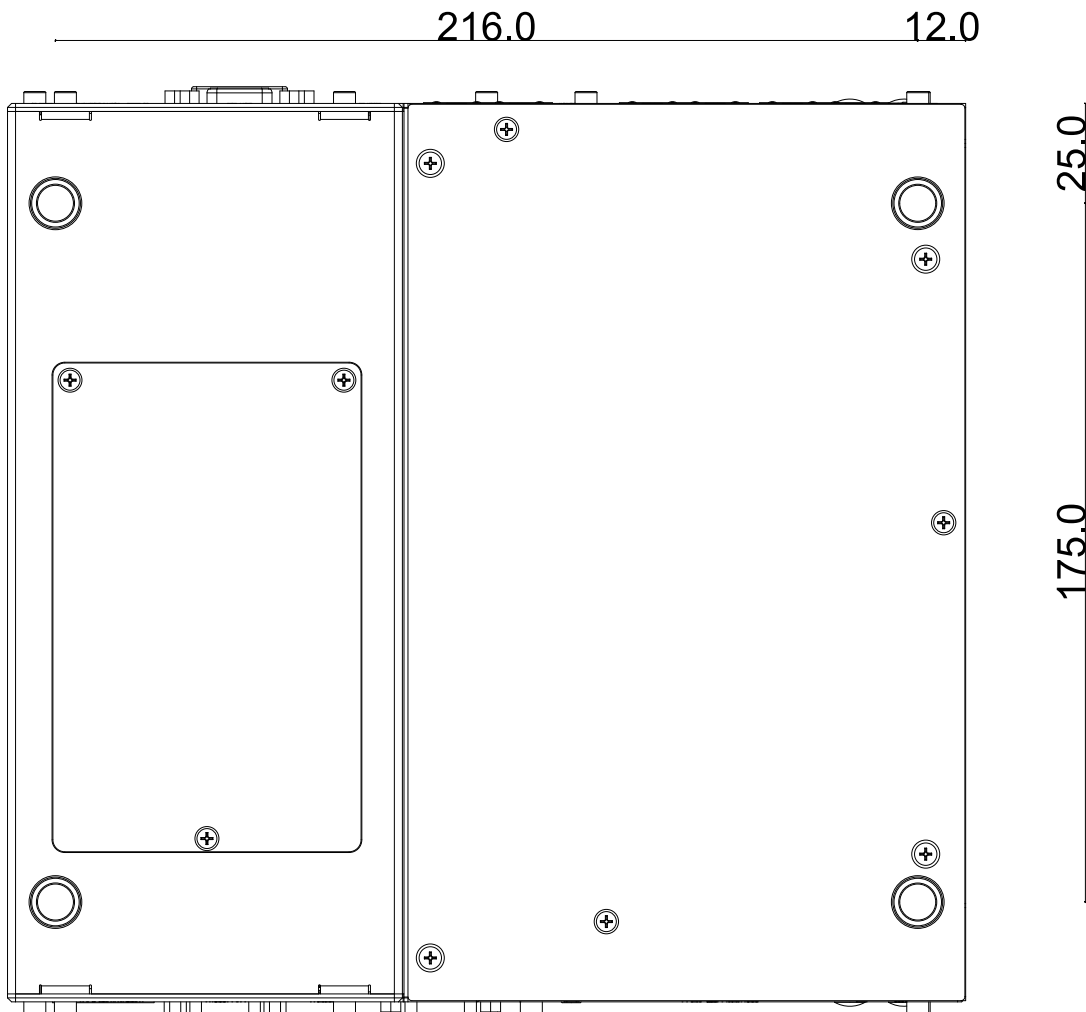

Chapter 3 Getting Start

In this chapter, we'll illustrate how to disassemble your Nuvo-5000 controller and install all necessary components such as CPU, memory and hard drive. Please follow the correct procedures to prevent any damage on your Nuvo-5000 controller.



NOTE

For demonstration purposes, Nuvo-5000 series will be used in most illustrations.

3.1 Disassemble your Nuvo-5000 Controller

In prior to install components such as CPU, memory and HDD to Nuvo-5000 series, you need to disassemble Nuvo-5000 controller and expose the PCBA. Please cautiously follow the procedures described here to prevent any damage on your Nuvo-5000 controller.

3.1.1 Disassemble Nuvo-5000E/P Series

1. Put the Nuvo-5000E/P controller upside down on a flat surface.
2. Unscrew four M3 flat-head screws and detach Cassette by pulling it up.



3. Unscrew seven hex bolts on the front panel and another seven hex bolts on the back panel. And remove both front panel and back panel.



(another 7 hex bolts on the opposite side)

4. Remove the bottom cover of Nuvo-5000E/P controller. You can see the PCBA exposed.

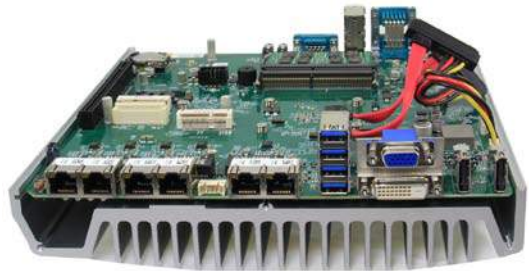
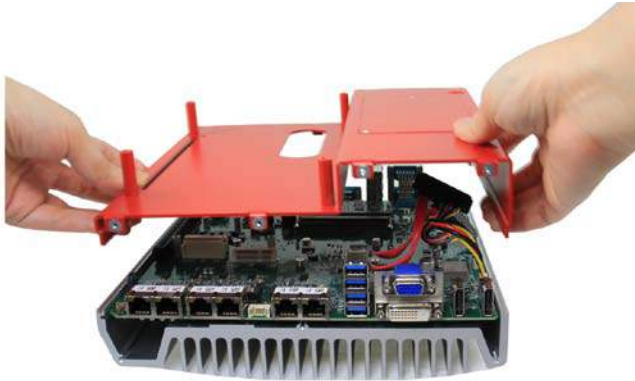

3.1.2 Disassemble Nuvo-5000LP Series

1. Put the Nuvo-5000LP controller upside down on a flat surface.
2. Unscrew six hex bolts on the front panel and another six hex bolts on the back panel.
And remove both front panel and back panel.



(another 6 hex bolts on the opposite side)

3. Remove the bottom cover of Nuvo-5000LP controller and the SATA cable attached to the hot-swappable HDD tray. You can see the PCBA exposed.

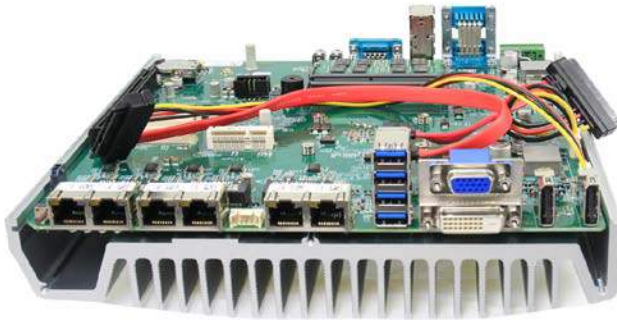

3.2 Install and Replace LGA1151 CPU

Nuvo-5000 series supports 6th-Gen, LGA1151 socket-type CPU. You can select the CPU according to your consideration of performance, cost and ambient condition. This section describes how to install or replace the CPU on your Nuvo-5000 controller.

Caution

Please carefully handle the exposed LGA socket on PCBA. The contacts of LGA1151 socket without protective cover are extremely easy to be damaged by foreign objects. You shall always put the protective cover back to the LGA socket when CPU is absent.

3.2.1 Identify PCBA Revision

On Nuvo-5000 series, we use a retaining bracket to hold CPU firmly to the LGA1151 socket. We have different bracket design on PCBA revision A1 and revision A2. Before you go further with installing or replacing CPU, please check the PCBA revision first and follow the corresponding procedures for CPU installation/replacement.

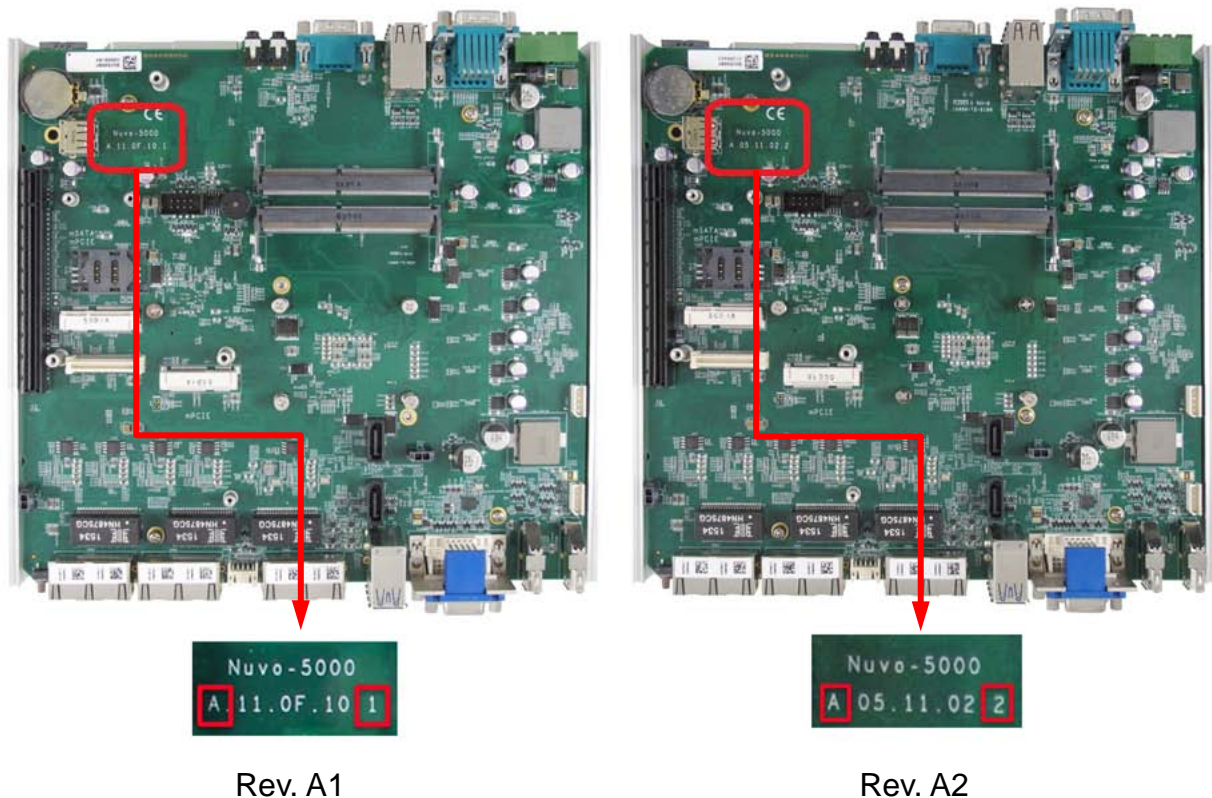

For Nuvo-5000 series Rev. A1, please refer to section 3.2.2 and 3.2.3 for instructions of installing/replacing CPU.

For Nuvo-5000 series Rev. A2, please refer to section 3.2.4 and 3.2.5 for instructions of installing/replacing CPU.

3.2.2 Install a CPU on Nuvo-5000 Rev. A1

For a Nuvo-5000 Rev. A1 barebone (without CPU installed), please follow steps described below to install a CPU on it.

1. Remove the PCBA from the heat-sink by loosening four M3 P-head screws (red circles).

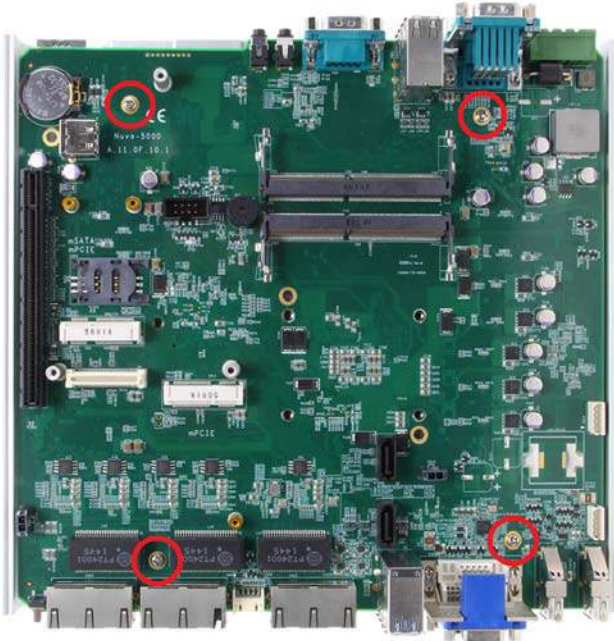

2. Place the PCBA on a flat surface. Remove the plastic protective cover from the LGA1151 socket.

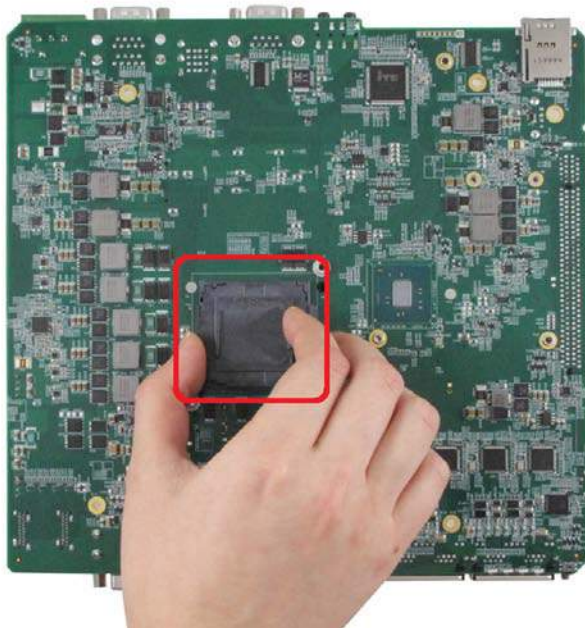

Caution

When the protective cover is removed and LGA1151 socket is exposed, please carefully handle the PCBA to avoid any damage on LGA socket.

3. Make sure that you line up the two guiding notches on the LGA1151 socket with the notches along the edges of the CPU. Place the CPU into the socket and by holding it firmly by the sides and lowering it into the socket.

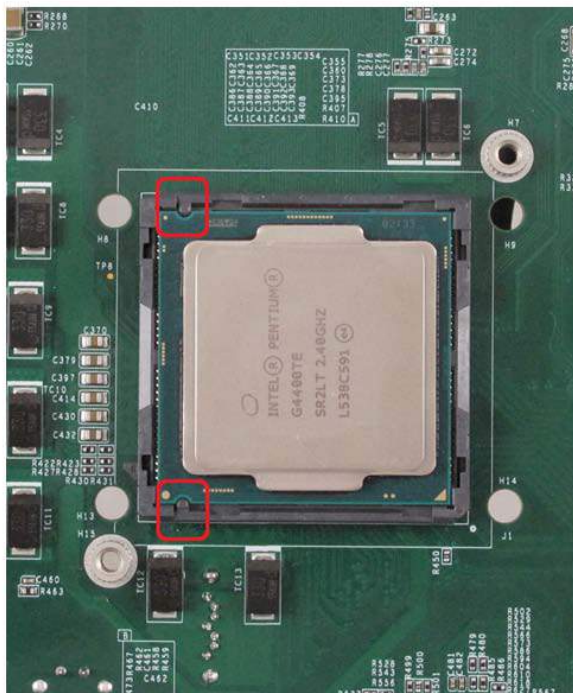

4. Get the CPU retaining bracket from the accessory box. Place it on the top of CPU and secure it to the PCBA using two M3 P-head screws.



- Remove all protective films of thermal pads of the heat-sink.

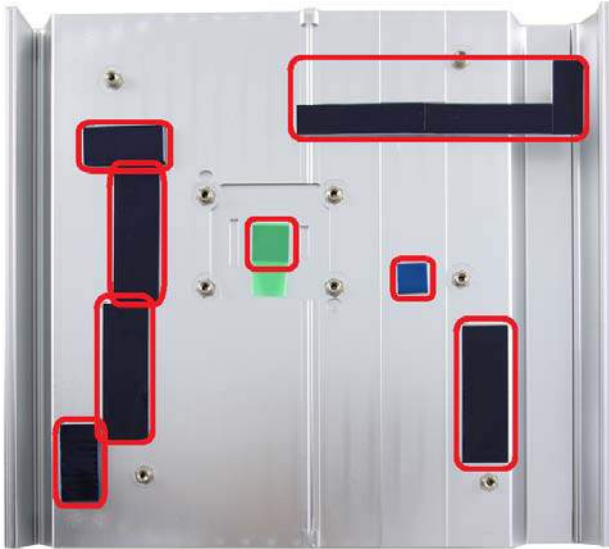

- Put the PCBA back to heat-sink. Make sure all the screw holes on PCBA are aligned with mounting posts of the heat-sink.

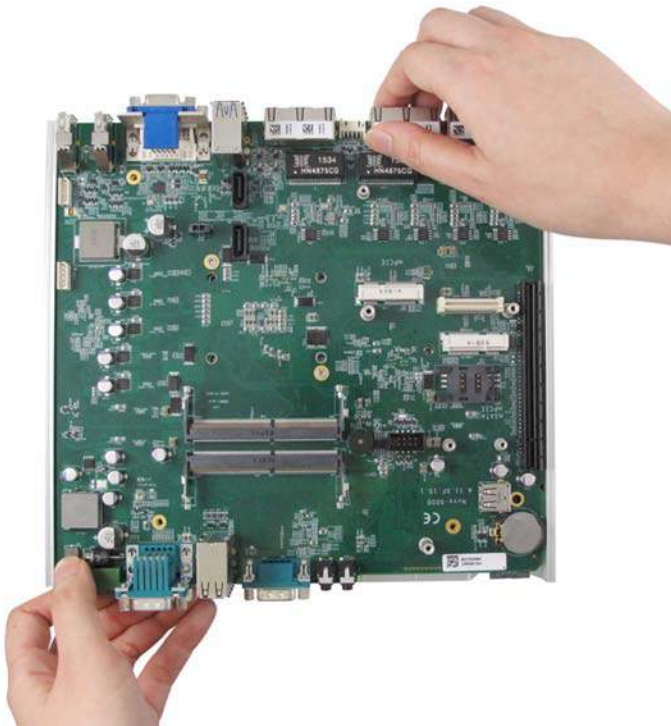

- Get five M3 spring screws from the accessory box. Fix them according to the order

indicated on the photo (red circles). And tighten four M3 P-head screws (yellow circles) to fix the PCBA to the heat-sink.

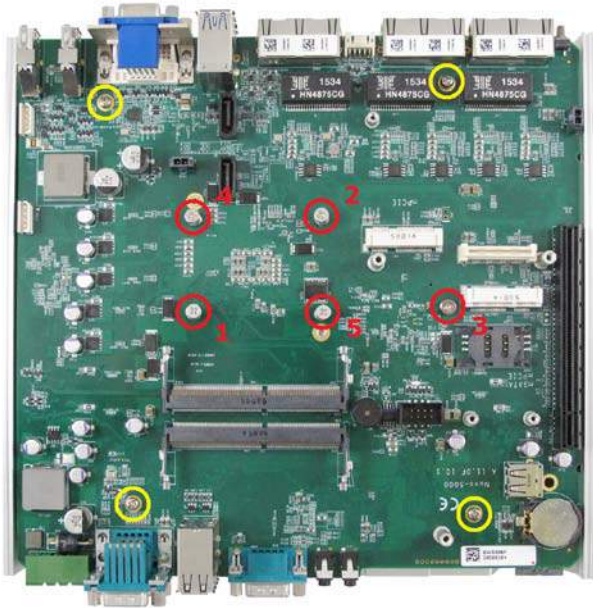

3.2.3 Replace the CPU on Nuvo-5000 Rev. A1

For a Nuvo-5000 Rev. A1 with CPU installed, please follow steps described below to replace the CPU on it.

Caution

Please make sure the PCBA/heat-sink assembly is cooled down to room temperature before you proceed with the replacement/installation procedures. Replacing the CPU at high temperature may damage the system.

1. Remove the PCBA from the heat-sink by loosening five M3 spring screws (red circles) and four M3 P-head screws (yellow circles).

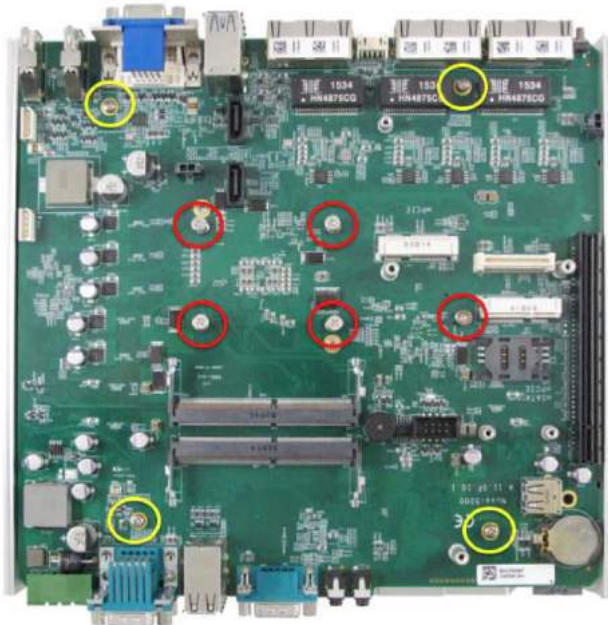

2. Hold the heat-sink firmly and gently push the PCBA forward and backward till you feel the CPU is detached from the thermal pad on the heat-sink.

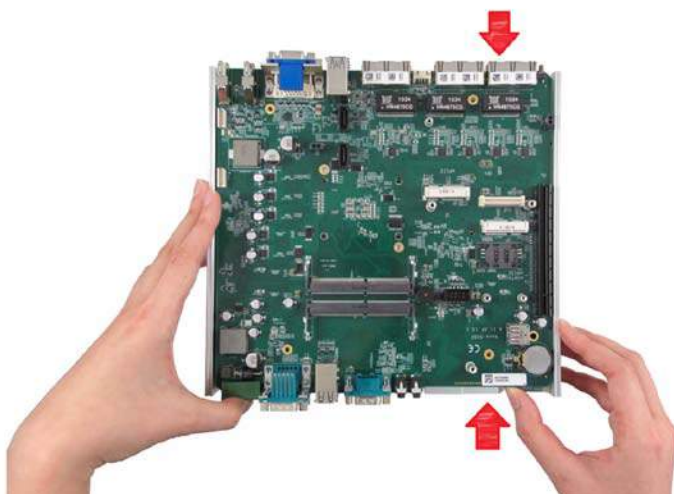

3. Gently lift the PCBA. Once you feel significant adhesion between PCBA and heat-sink, DO NOT apply more force for lifting it. In this case, please repeat step 2 to separate the PCBA from the heat-sink.

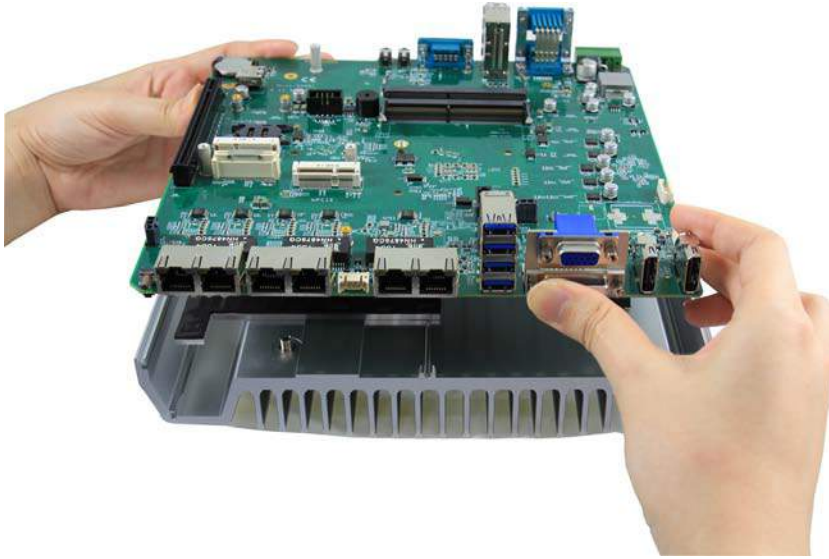

4. Place the PCBA on a flat surface. The CPU is held by a bracket on the PCBA. Unscrew two M3 P-head screws to remove the CPU retaining bracket. And carefully pick up the CPU.



Caution

When the original CPU is removed and LGA1151 socket is exposed, please carefully handle the PCBA to avoid any damage on LGA socket.

5. Check the condition of thermal pads on the heat-sink, especially the thermal pad for CPU. If it's broken, please replace it with a new one.

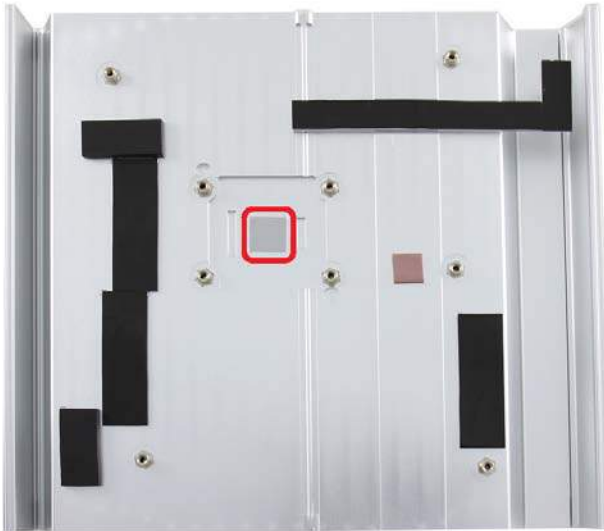

6. Follow steps described in step 3 to step 7 in section 3.2.2 to install a new CPU to your Nuvo-5000 controller.

3.2.4 Install a CPU on Nuvo-5000 Rev. A2

For a Nuvo-5000 Rev. A2 barebone (without CPU installed), please follow steps described below to install a CPU on it.

1. Remove the PCBA from the heat-sink by loosening four M3 P-head (red circles).

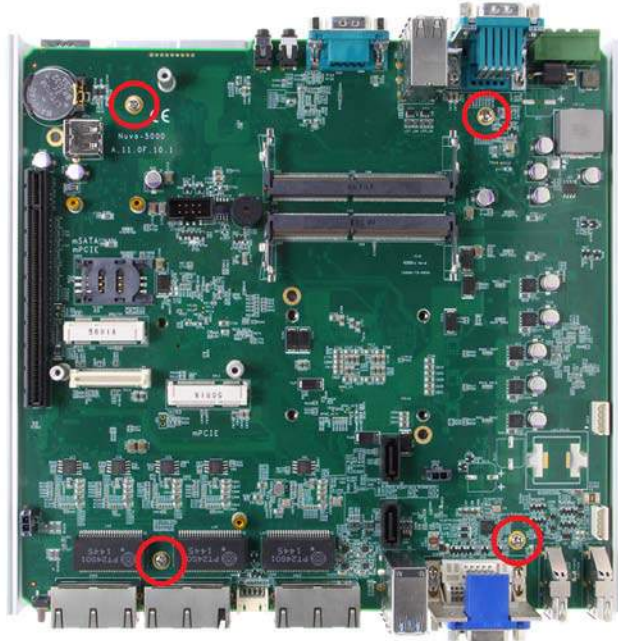

2. Place the PCBA on a flat surface. Remove the plastic protective cover from the LGA1151 socket.



Caution

When the protective cover is removed and LGA1151 socket is exposed, please carefully handle the PCBA to avoid any damage on LGA socket.

3. Make sure that you line up the two guiding notches on the LGA1151 socket with the notches along the edges of the CPU. Place the CPU into the socket and by holding it firmly by the sides and lowering it into the socket.

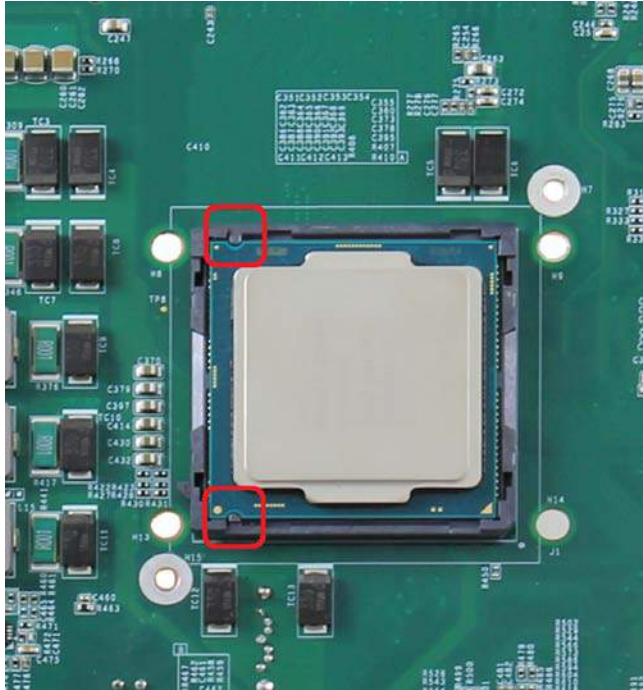

4. Get the CPU retaining bracket from the accessory box and place it on the top of CPU. On Nuvo-5000 Rev. A2, the CPU retaining bracket must be screwed from the opposite side. Please hold the CPU and bracket firmly while turning the PCBA upside down, and secure the CPU retaining bracket with two M3 P-head screws.

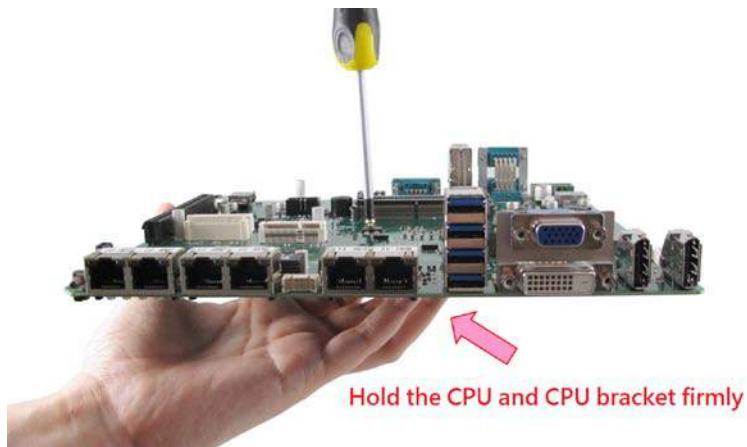

5. Remove all protective films of thermal pads of the heat-sink.

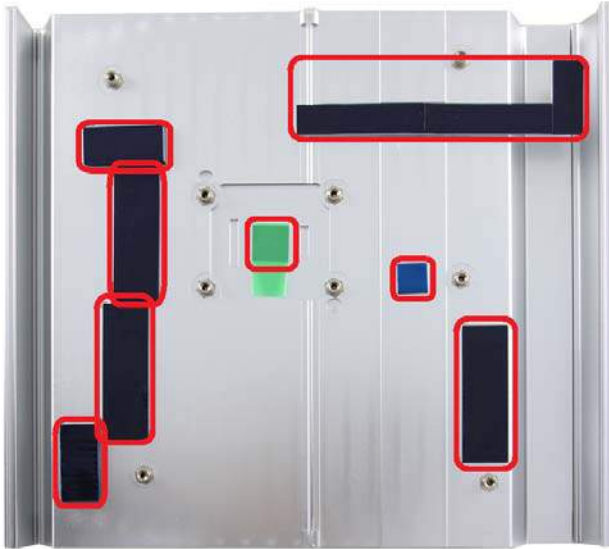

6. Put the PCBA back to heat-sink. Make sure all the screw holes on PCBA are aligned with mounting posts of the heat-sink.

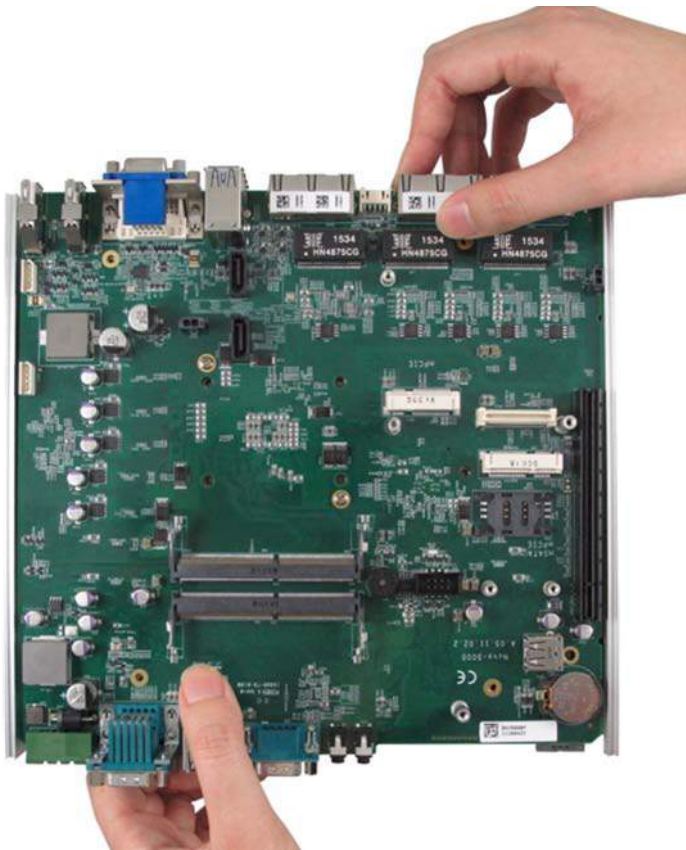

7. Get five M3 spring screws from the accessory box. Fix them according to the order indicated on the photo (red circles). And tighten four M3 P-head screws (yellow circles) to fix the PCBA to the heat-sink.

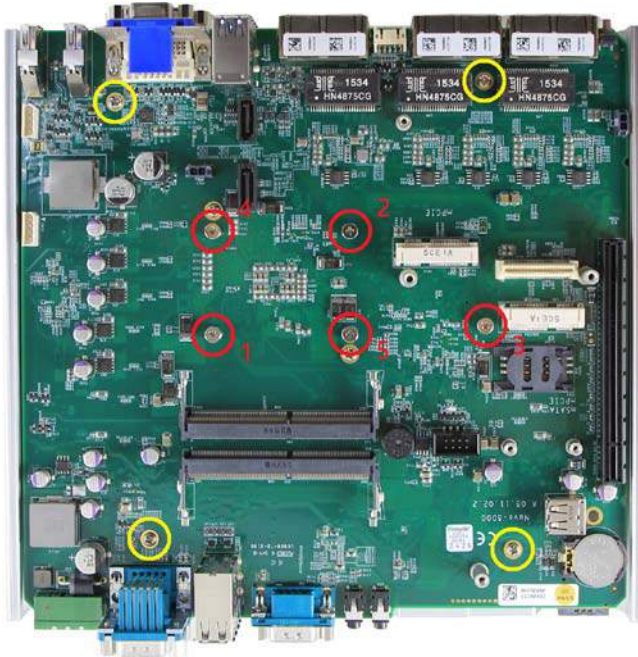

3.2.5 Replace the CPU on Nuvo-5000 Rev. A1

For a Nuvo-5000 Rev. A2 with CPU installed, please follow steps described below to replace the CPU on it.

Caution

Please make sure the PCBA/heat-sink assembly is cooled down to room temperature before you proceed with the installation/replacement procedures. Replacing the CPU at high temperature may damage the system.

1. Remove the PCBA from the heat-sink by loosening five M3 spring screws (red circles) and six M3 P-head (yellow circles).

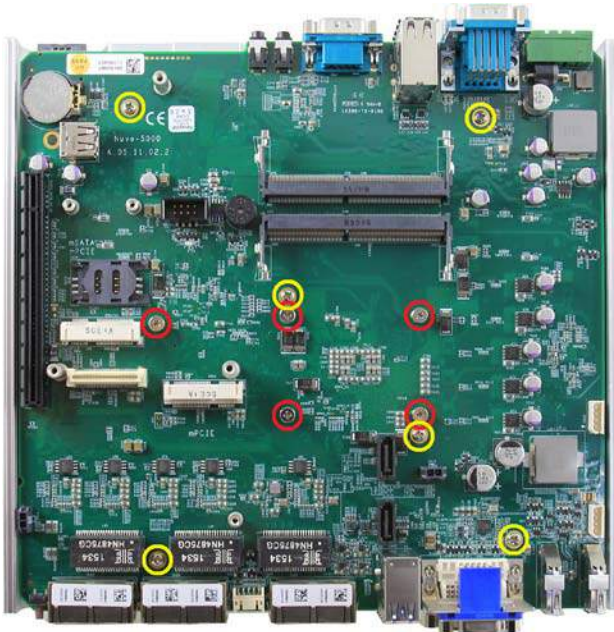

2. Gently lift the PCBA from the heat-sink. The CPU and CPU retaining bracket shall stay with the heat-sink.

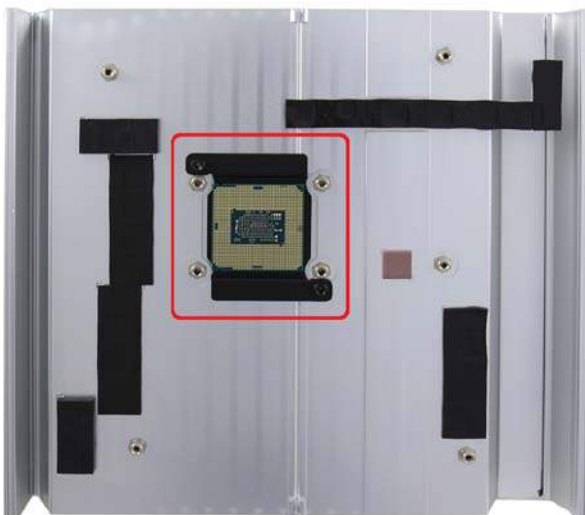

Caution

When the PCBA is detached and LGA1151 socket is exposed, please carefully handle the PCBA to avoid any damage on LGA socket.

3. Insert a slotted screwdriver into the gap between the CPU retaining bracket and the heat-sink, and lever the CPU and bracket. Please DO NOT apply force to the CPU otherwise the CPU can be damaged.



4. Check the condition of thermal pads on the heat-sink, especially the thermal pad for CPU. If it's broken, please replace it with a new one.

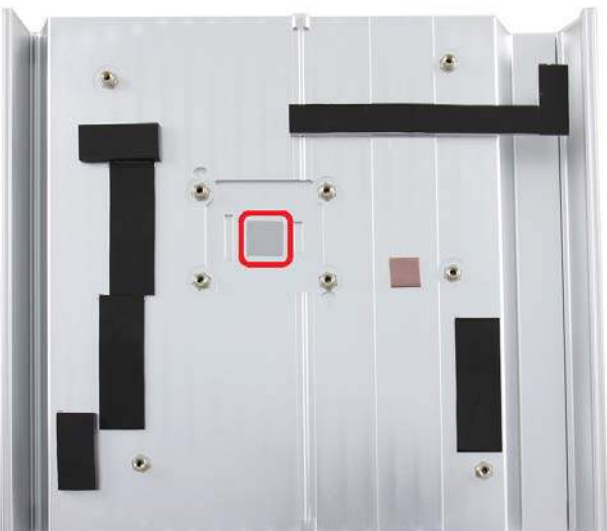

5. Follow steps described in step 3 to step 7 in section 3.2.4 to install a new CPU to your Nuvo-5000 controller.

3.3 Install DDR4 SODIMM Module

Nuvo-5000 series provides two 260-pin, SODIMM sockets for installing DDR4 memory modules. It supports maximal 32GB capacity by installing two 16 GB DDR4-2133 SODIMM modules. You can install/replace DDR4 SODIMM modules by following the steps described in this section.



NOTE

For demonstration purposes, Nuvo-5000 series will be used in most illustrations.

3.3.1 Install DDR4 SODIMM Module for Nuvo-5000E/P Series

1. Follow the steps described in section 3.1.1 to disassemble the Nuvo-5000E/P chassis. You can see the DDR4 SODIMM sockets on the PCBA exposed.
2. Tile the SODIMM module and insert it to the SODIMM socket. As it's firmly contacted with socket connectors, press it down until the clamps of the socket snap into the latching position of SODIMM module.

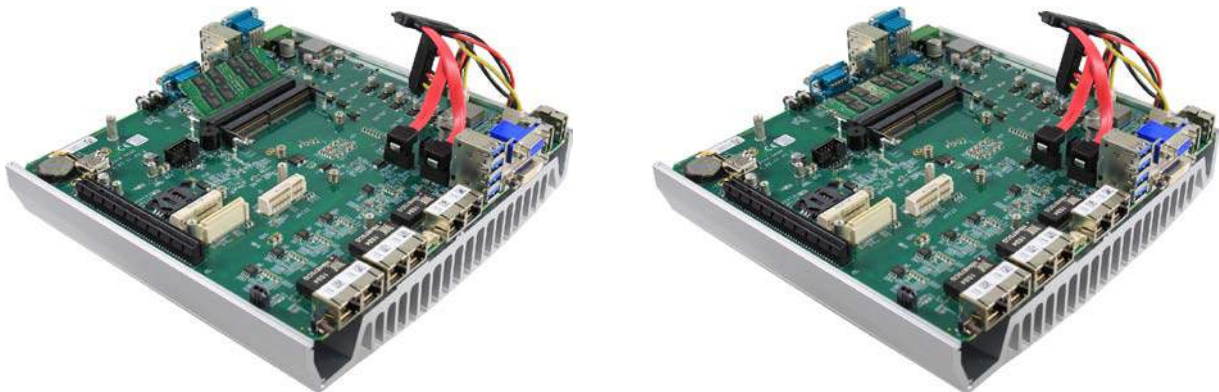

3. Repeat step 2 if you want to install the second DDR4 SODIMM module.

3.3.2 Install DDR4 SODIMM Module for Nuvo-5000LP Series

1. Follow the steps described in section 3.1.2 to disassemble the Nuvo-5000LP chassis. You can see the DDR4 SODIMM sockets on the PCBA exposed.
2. Tile the SODIMM module and insert it to the SODIMM socket. As it's firmly contacted with socket connectors, press it down until the clamps of the socket snap into the latching position of SODIMM module.

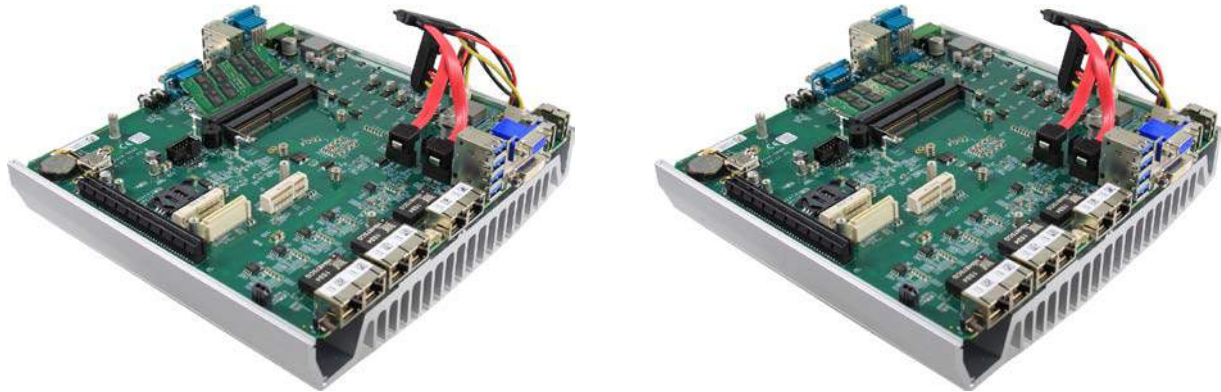

3. Repeat step 2 if you want to install the second DDR4 SODIMM module.

3.4 Install 2.5" SATA HDD/SSD

Nuvo-5000 series has two SATA ports for connecting SATA HDD or SSD drives. On Nuvo-5000E/P series, SATA ports are used in conjunction with the HDD bracket on the trapdoor to accommodate two 2.5" HDD/SSD. On Nuvo-5000LP series, the first SATA port is connected to the panel-accessible, hot-swappable HDD tray and the second port is used in conjunction with the HDD bracket on the trapdoor. Please follow instructions described in this section to install SATA HDD/SSD to your Nuvo-5000 controller.



NOTE

For demonstration purposes, Nuvo-5000 series will be used in most illustrations.

3.4.1 Install 2.5" SATA HDD/SSD to HDD Bracket

- Put the Nuvo-5000E/P or Nuvo-5000LP controller upside down on a flat surface. You can see the trapdoor exposed. Use a Philips screwdriver to loosen three M3 flat-head screws and remove the trapdoor from the bottom cover.



(Nuvo-5000E/P)

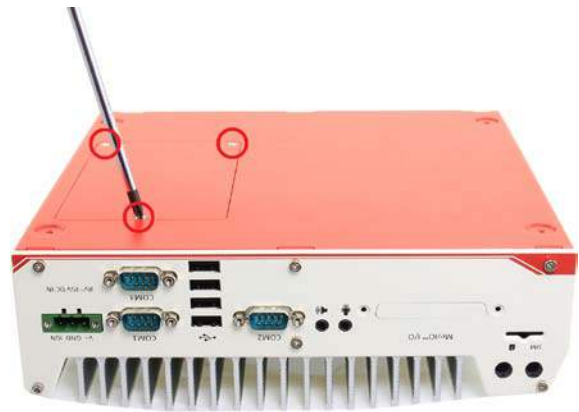

(Nuvo-5000LP)

- Get the HDD thermal pad from the accessory box. Remove protective films on both sides and place the thermal pad on the center of HDD bracket.



(HDD bracket of Nuvo-5000E/P)



(HDD bracket of Nuvo-5000LP)

- Place the HDD/SSD into the bracket and gently push it down to make it contact with the thermal pad. Use a Philips screwdriver to fix it with M3 flat-head screws from the accessory box. Please note that the HDD must be placed in the right direction as below.



(HDD bracket of Nuvo-5000E/P)



(HDD bracket of Nuvo-5000LP)

- Pull out the SATA cable inside the chassis and connect it to HDD/SSD.



(Nuvo-5000E/P)



(Nuvo-5000LP)

- Place the HDD/bracket assembly back to the bottom cover. And fix it with three M3 flat-head screws.



(Nuvo-5000E/P)



(Nuvo-5000LP)

3.4.1 Install 2.5" SATA HDD/SSD to HDD Tray (Nuvo-5000LP Only)

1. Find the door of hot-swappable HDD tray on the front panel of Nuvo-5000LP controller.



2. Pull the handle of the tray door to open the hot-swappable HDD tray.



3. Insert the 2.5" HDD/SSD into the hot-swappable HDD tray. Please note the HDD must be placed in the right direction when you install it.



4. Push the handle back to the HDD tray along with the 2.5" HDD till it snaps into the latching position.



5. If necessary, get the key from the accessory box to lock the door of HDD tray and secure the HDD/SSD.



3.5 Install Mini-PCle Module

Nuvo-5000 series provides two full-size mini-PCle sockets with SIM card support. You can install off-the-shelf mini-PCle modules to expand functions for Nuvo-5000 controller. In this section, we demonstrate how to install a mini-PCle 3G module and its antenna to the Nuvo-5000 controller.



NOTE

For demonstration purposes, Nuvo-5000 series will be used in most illustrations.

1. Follow the steps described in section 3.1 to disassemble the Nuvo-5000 controller. You can see mini-PCle sockets on the PCBA exposed.

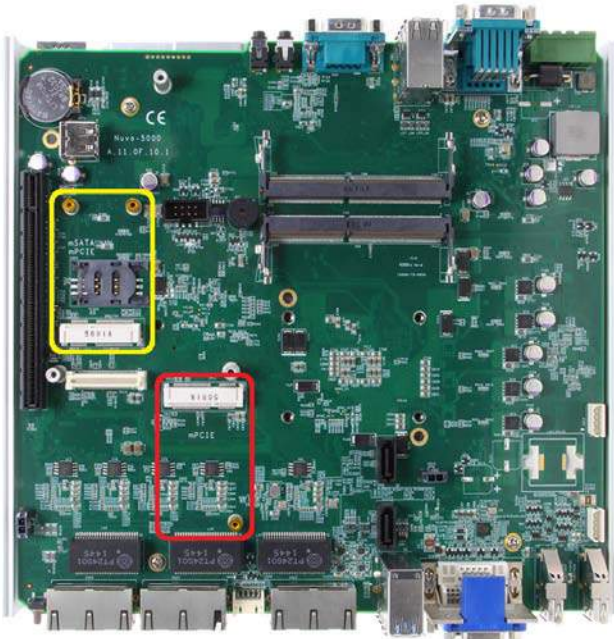

2. Tilt the mini-PCle 3G module and insert it into the mini-PCle #2 socket (marked as red). And fix the module with one M2.5 P-head screw.



3. Attach the IPEX-to-SMA cable to the 3G module.

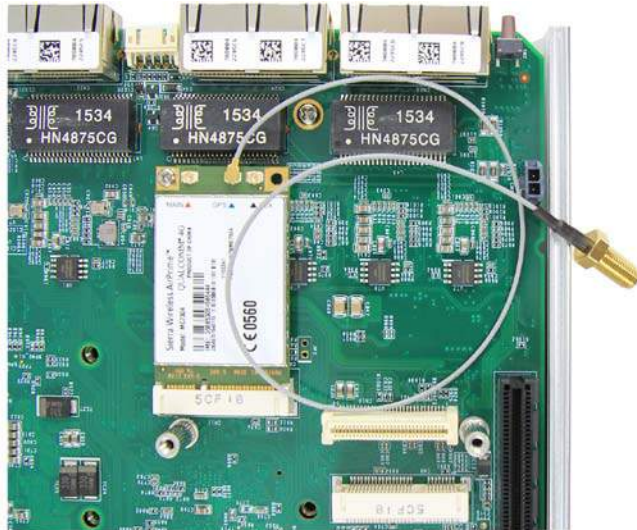

4. Fix the SMA connector of the IPEX-to-SMA cable to one of the four antenna apertures on either front panel or back panel.



5. Recover the front panel, back panel and the bottom cover and attach a 3G antenna to the SMA connector. The mini-PCle #2 socket shall be used in conjunction with the panel-accessible SIM socket on the back panel. Insert the SIM card upside down to the SIM socket to support 3G communication for your Nuvo-5000 controller.



3.6 Install MezIO™ Module

Nuvo-5000 series is designed with Neosys' MezIO™ interface. You can install a MezIO™ module to expand application-oriented I/O function. In this section, we demonstrate the procedure of installing Neosys MezIO-C180 to add eight additional COM ports to your Nuvo-5000 controller.



NOTE

For demonstration purposes, Nuvo-5000 series will be used in most illustrations.

1. Follow the steps described in section 3.1 to disassemble the Nuvo-5000 controller. You can see MezIO™ interface connector on the PCBA.

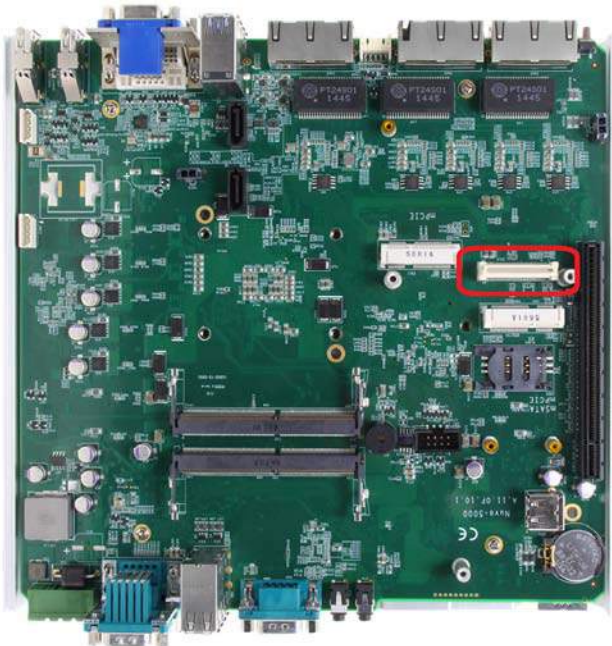

2. Align the board-to-board connector on the MezIO-C180 module to to connector on the PCBA. Gently push it down and make sure the connector is firmly contacted. Fix the MezIO™ module with three M3 P-head screws.

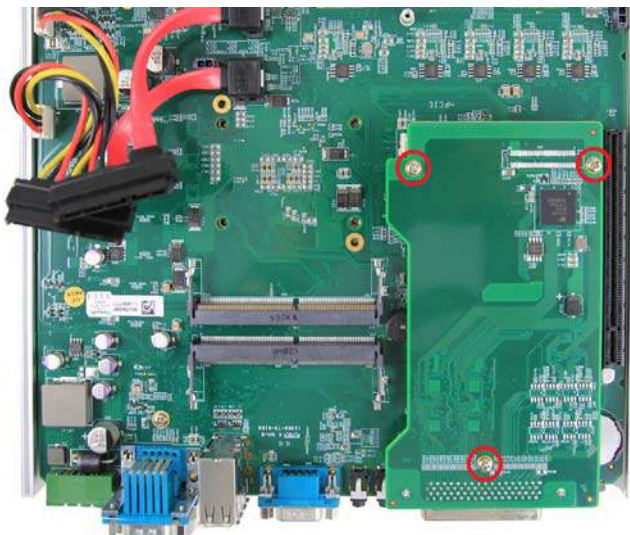

3. Remove the pre-cutting plate of MezIO™ I/O aperture on the back panel to expose the SCSI-II 68-pin connector of the MezIO-C180 module.

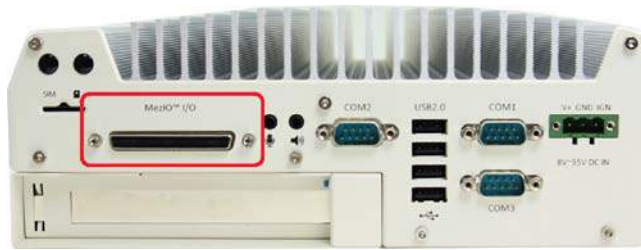

3.7 Install Add-on Card in Cassette

The expansion Cassette is used to accommodate a PCI Express or PCI add-on card. To install an add-on card into Cassette, please refer to the instructions described in this section.

1. Remove Cassette from the system by loosening four M4 screws.



Nuvo-5000E/P systems



Nuvo-5026E series



Gently wiggle and detach the Cassette enclosure from the main system enclosure

- For Nuvo-5026E series, unscrew three screws shown below to remove the Cassette cover.



- Pull the cover of Cassette toward arrow pointing direction to open it. And then remove the blank faceplate installed in Cassette by loosening a M3 screw.

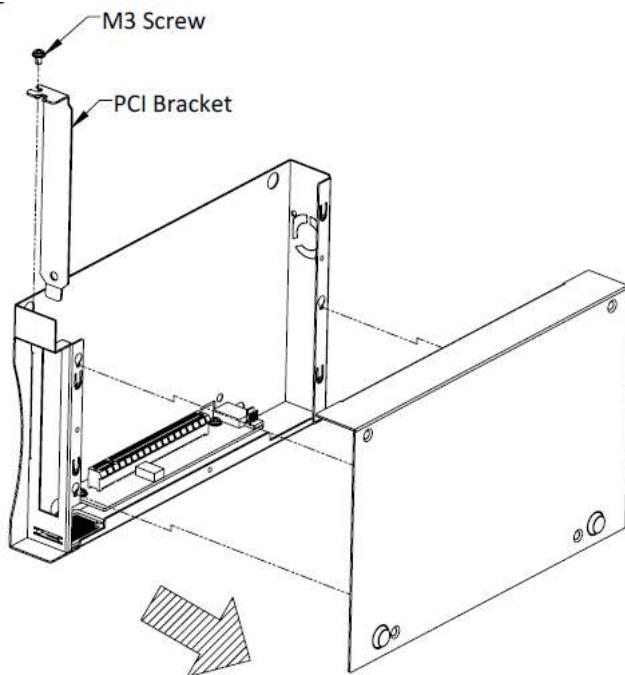

4. Install a PCI/PCIe add-on card into the PCI/PCIe connector. Note that the tail of faceplate of the add-on card must be inserted into the mortise. Tighten the add-on card using a M3 screw.

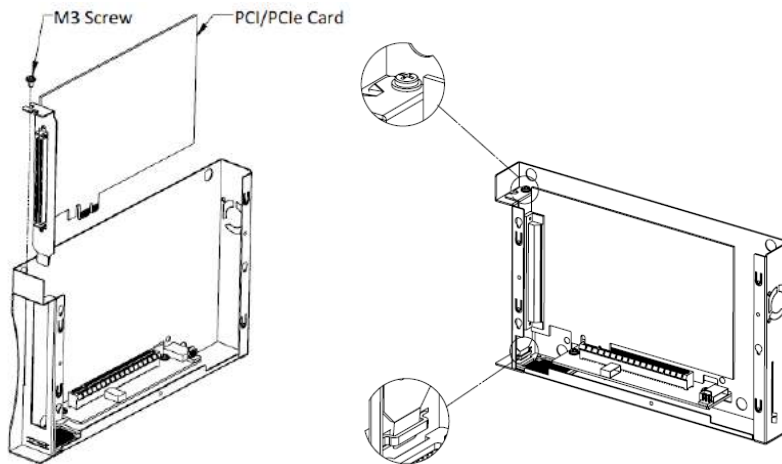

5. Recover Cassette and assemble it to system enclosure. Fix the Cassette with four M4 screws.

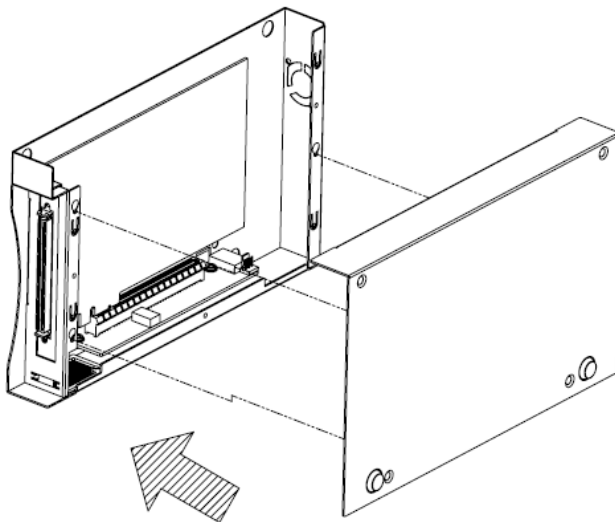

3.8 Mount your System

Nuvo-5000 series/ Nuvo-5026E series provide versatile ways of mounting. You can use wall-mounting brackets shipped with the system to mount it on the wall. Neousys also offers optional DIN rail mounting kit to mount it on a DIN rail. To mount your system controller, please refer to the instructions listed below.

3.8.1 Mount your System on the Wall

The system is shipped with two wall-mounting brackets as the standard mounting option. Please follow steps below to mount your system on a flat surface.

1. Get two wall-mounting brackets and four M4 screws from the accessory box. Fix the mounting brackets to system using M4 screws.

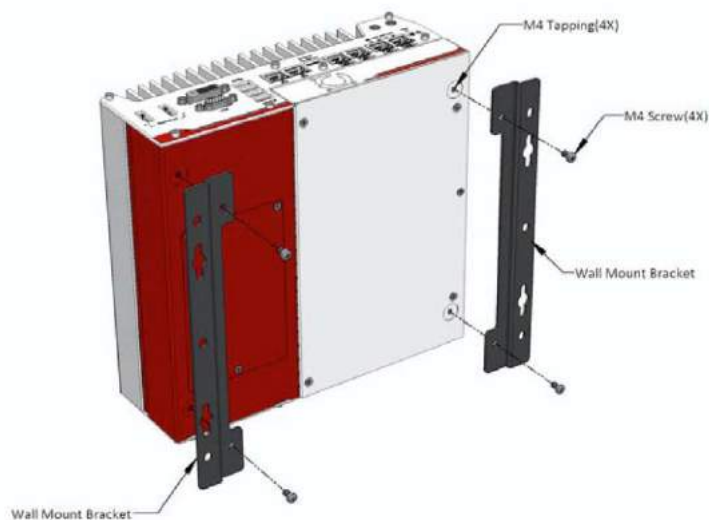

Nuvo-5000 series

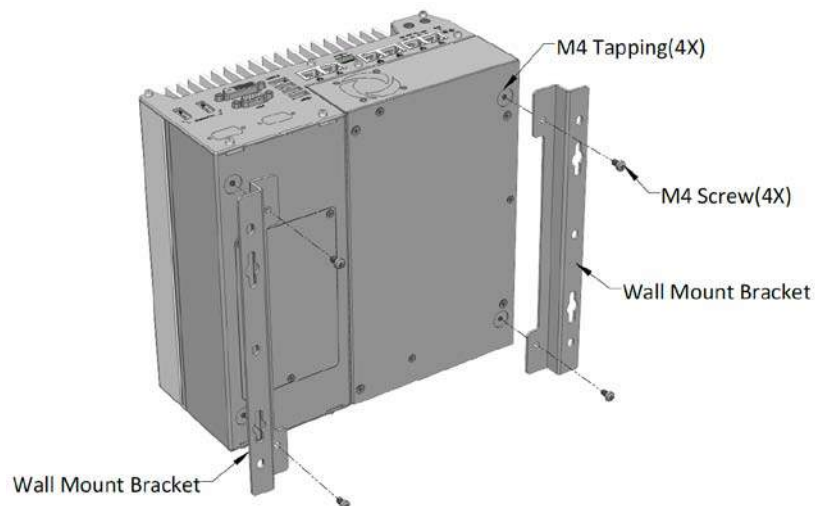

Nuvo-5026E/ Nuvo-5026E-PoE

- 2. Place the system on a flat surface and fix it with screws. You can also take advantage of the keyhole-shaped holes of mounting brackets to suspend the system on the Wall.

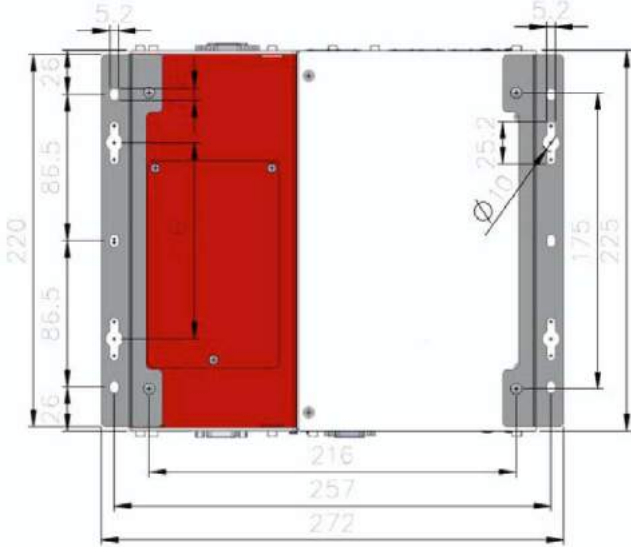

Nuvo-5000 series

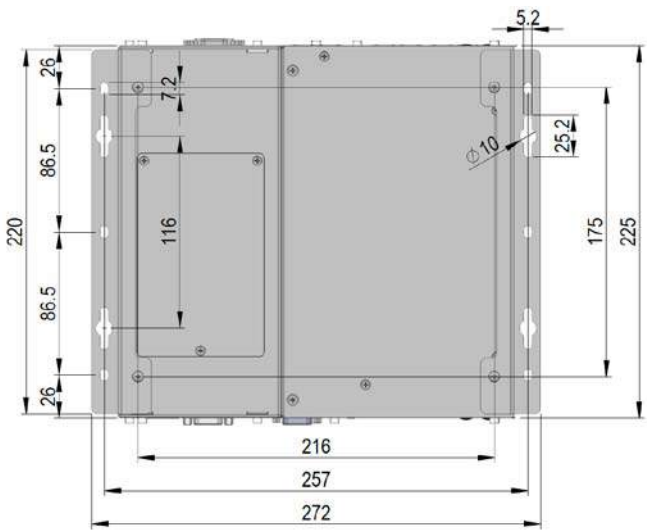

Nuvo-5026E series

- 3. For best efficiency of heat dissipation, please mount your system in a right direction.

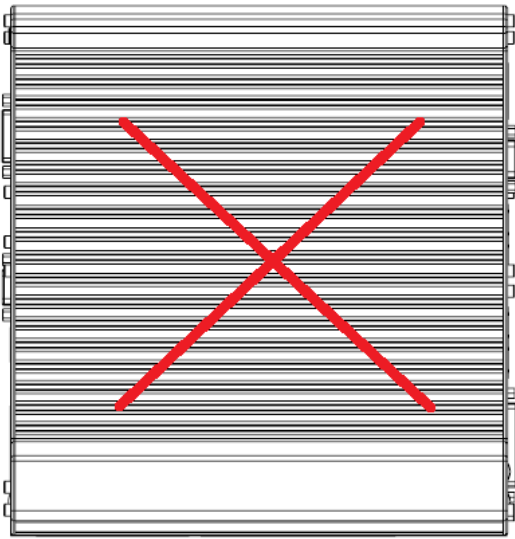
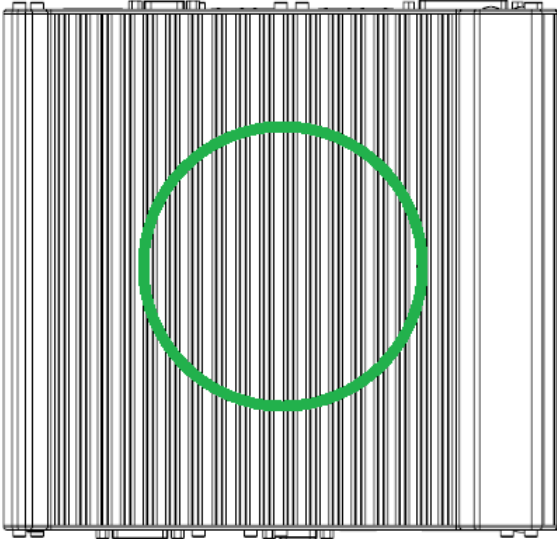

3.8.2 Mount your System on the DIN-rail

Neusys also provides the option of the DIN-rail mounting kit. The kit includes a bracket and a DIN-rail mounting clip. You should fix the clip to the bracket using four M4 flat-head screws first, and then fix the bracket assembly to the system with another four M4 screws. This option can be useful if you want to deploy it inside an equipment cabinet where DIN rail is available.

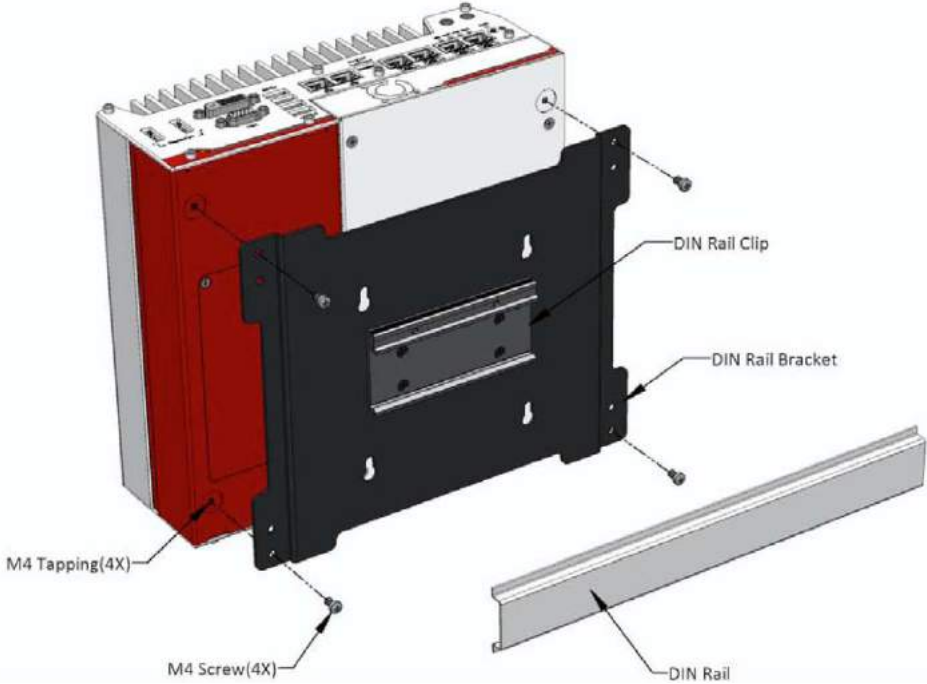

Nuvo-5000 series

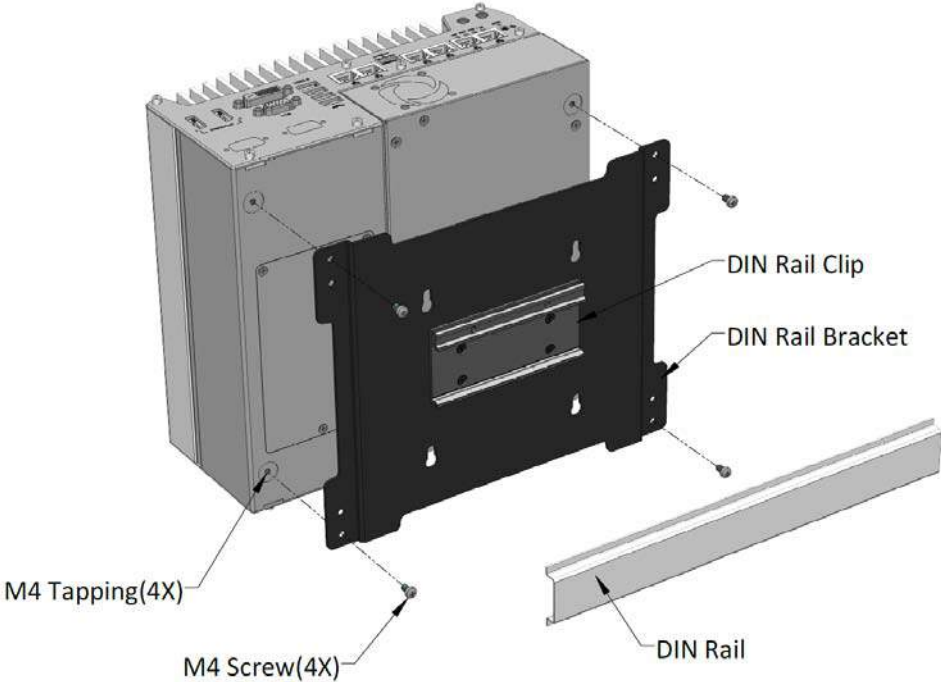

Nuvo-5026E series



3.9 Connect DC Power to your System

Nuvo-5000 series uses a 3-pin pluggable terminal block to accept 8~35V DC power input. It provides the reliable way for directly wiring the DC power. The pluggable terminal block is also used to accept ignition signal if MezIO-V20 ignition control module is installed. To connect DC power via the 3-pin pluggable terminal block, please follow the steps described below.

1. Make sure the external DC power supply is power off or disconnected before wiring.
2. Get the 3-pin pluggable terminal block from the accessory box. The terminal block fits the wires with a gauge of 12~24 AWG.
3. Carefully identify the positive and negative contacts of your DC power supply and pluggable terminal block. The polarities between DC power supply and terminal block must be positive (+) to positive (+) and ground (GND) to ground (GND).



4. Insert the wires to correct contacts of pluggable terminal block and tighten clamping screws using a Philips screwdriver.
5. Firmly plug the terminal block into a receptacle on the rear panel, and tighten the captive screws using a Slotted screwdriver.

Caution

1. *Nuvo-5000 series accepts 8~35 VDC when using terminal block for DC input. Please make sure the voltage and polarity of DC power is correct before you connect it to Nuvo-5000 controller. Supplying a voltage over 35V or incorrect polarity will damage the system.*

3.10 Power on your Nuvo-5000 Controller

For better flexibility of operation, Nuvo-5000 series provides three alternatives to power on your Nuvo-5000 controller. You can turn on your Nuvo-5000 controller by pressing the power button, using an external non-latched switch, or by sending a special LAN packet. In this section, we illustrate these ways to power on your Nuvo-5000 controller.

3.10.1 Power on Using the Power Button

This is the simplest way to turn on your Nuvo-5000 controller. The power button on the front panel is a non-latched switch and behaves the ATX-mode on/off control. As DC power is connected, push the power button will turn on the system as well as the PWR LED indicator. Push the button when system is on will turn off the system. If your operating system supports ATX power mode (i.e. Microsoft Windows or Linux), push the power button causes a pre-defined system behavior, such as shutdown or hibernation.



3.10.2 Power on Using an External Non-latched Switch

For an application which places Nuvo-5000 controller inside a cabinet, it's useful to control the on/off of the system using an external switch. Nuvo-5000 series provides a 2x5, 2.0mm pitch wafer connector (for detail, please refer to section 2.2.5) for connecting a non-latched switch and behaves ATX-mode power on/off control. The external non-latched switch acts exactly the same as the power button on the front panel. To power on Nuvo-5000 controller using an external non-latched switch (ATX-mode), please follow the steps described below.

1. Prepare a non-latched switch with a 2x5, 2.0mm pitch wafer terminal. Note that the switch must be connected to pin#1 and pin#2 (polarity is negligible).



2. Connect the wafer terminal to the wafer connector on the front panel of the Nuvo-5000 controller.

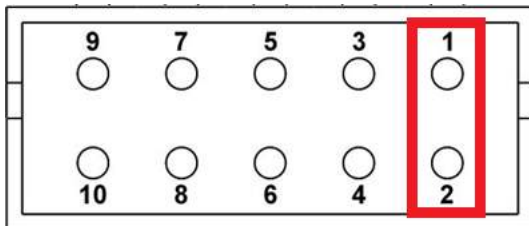

3. Push the non-latched switch will turn on the system (the PWR LED indicator on the front panel is on at the same time). Push the non-latched switch when system is on will turn off the system. If your operating system supports ATX power mode (i.e. Microsoft Windows or Linux), push the power button causes a pre-defined system behavior, such as shutdown or hibernation.

3.10.3 Power on Nuvo-5000 Using Wake-on-LAN Function

Wake-on-LAN (WOL) is a mechanism to wake up a computer system from a S5 (system off with standby power) state via issuing a magic packet. Nuvo-5000 series implements the Wake-on-LAN function for the GbE port marked below.



To enable WOL function and power on you Nuvo-5000 controller, please follow the steps described below.

1. When Nuvo-5000 controller boots up, press F2 to enter BIOS setup utility.
2. Enter the **[Power]** menu. And configure the **[Wake On LAN]** option as **[Enabled]**. This setting enables the Wake-on-LAN function for Nuvo-5000 series. Please refer to section 4.1.6 for the instruction of configuring this BIOS option.
3. In Windows 7 system, identify the Local Area Connection of corresponding Intel® I219 Gigabit Controller and click the **Configure** button.

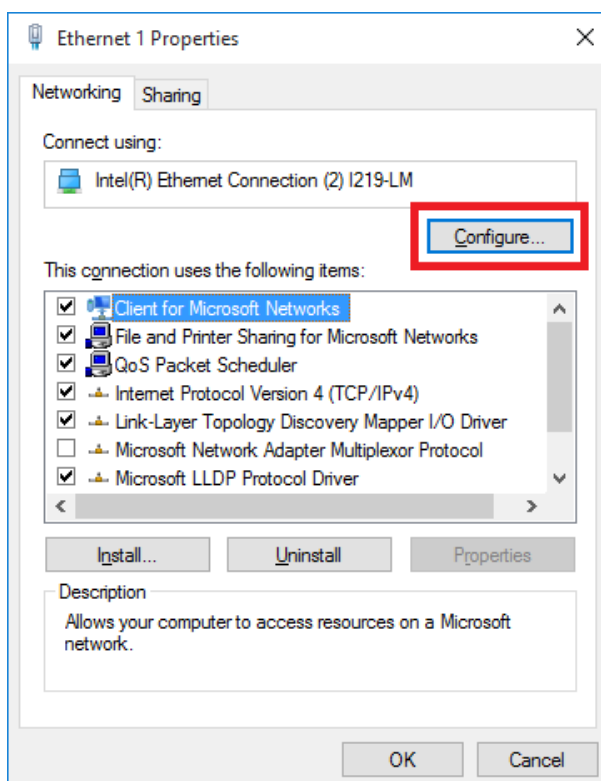

4. Click the **Power Management** tag, and check the following two options accordingly

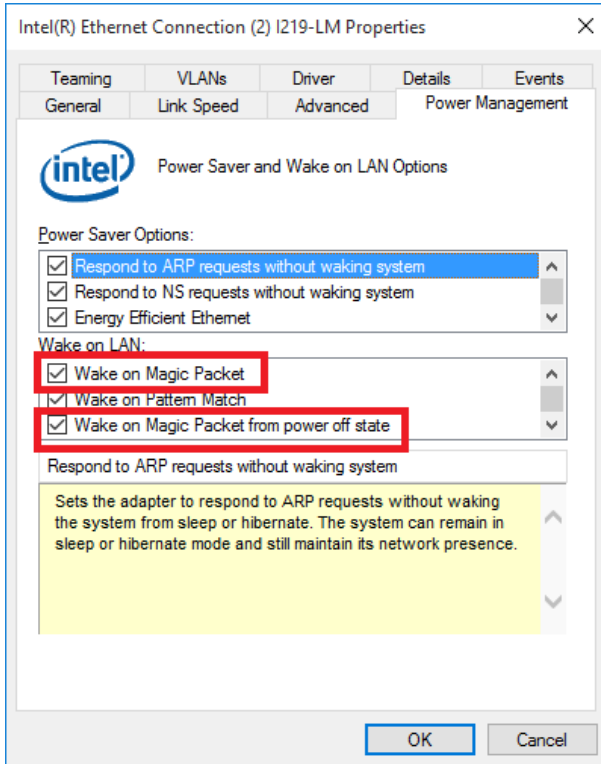

● **Wake on Magic Packet**

Nuvo-5000 series can wake from S5 state when receiving a magic packet. The magic packet is a broadcast frame containing anywhere within its payload 6 bytes of all 255 (FF FF FF FF FF FF in hexadecimal), followed by sixteen repetitions of the target computer's 48-bit MAC address.

For example, NIC's 48-bit MAC Address is 78h D0h 04h 0Ah 0Bh 0Ch

```

DESTINATION SOURCE MISC
FF FF FF FF FF FF
78 D0 04 0A 0B 0C 78 D0 04 0A 0B 0C
78 D0 04 0A 0B 0C 78 D0 04 0A 0B 0C
78 D0 04 0A 0B 0C 78 D0 04 0A 0B 0C
78 D0 04 0A 0B 0C 78 D0 04 0A 0B 0C
78 D0 04 0A 0B 0C 78 D0 04 0A 0B 0C
78 D0 04 0A 0B 0C 78 D0 04 0A 0B 0C
78 D0 04 0A 0B 0C 78 D0 04 0A 0B 0C
78 D0 04 0A 0B 0C 78 D0 04 0A 0B 0C
78 D0 04 0A 0B 0C 78 D0 04 0A 0B 0C
MISC    CRC
    
```

There are some free tools available on Internet that can be used to send a magic packet. Please refer to the following link to understand more about Magic Packet.
<http://en.wikipedia.org/wiki/Wake-on-LAN>



Chapter 4 BIOS and Driver

4.1 BIOS Settings

Nuvo-5000 series is shipped with factory-default BIOS settings cautiously programmed for best performance and compatibility. In this section, we'll illustrate some of BIOS settings you may need to modify. Please always make sure you understand the effect of change before you proceed with any modification.

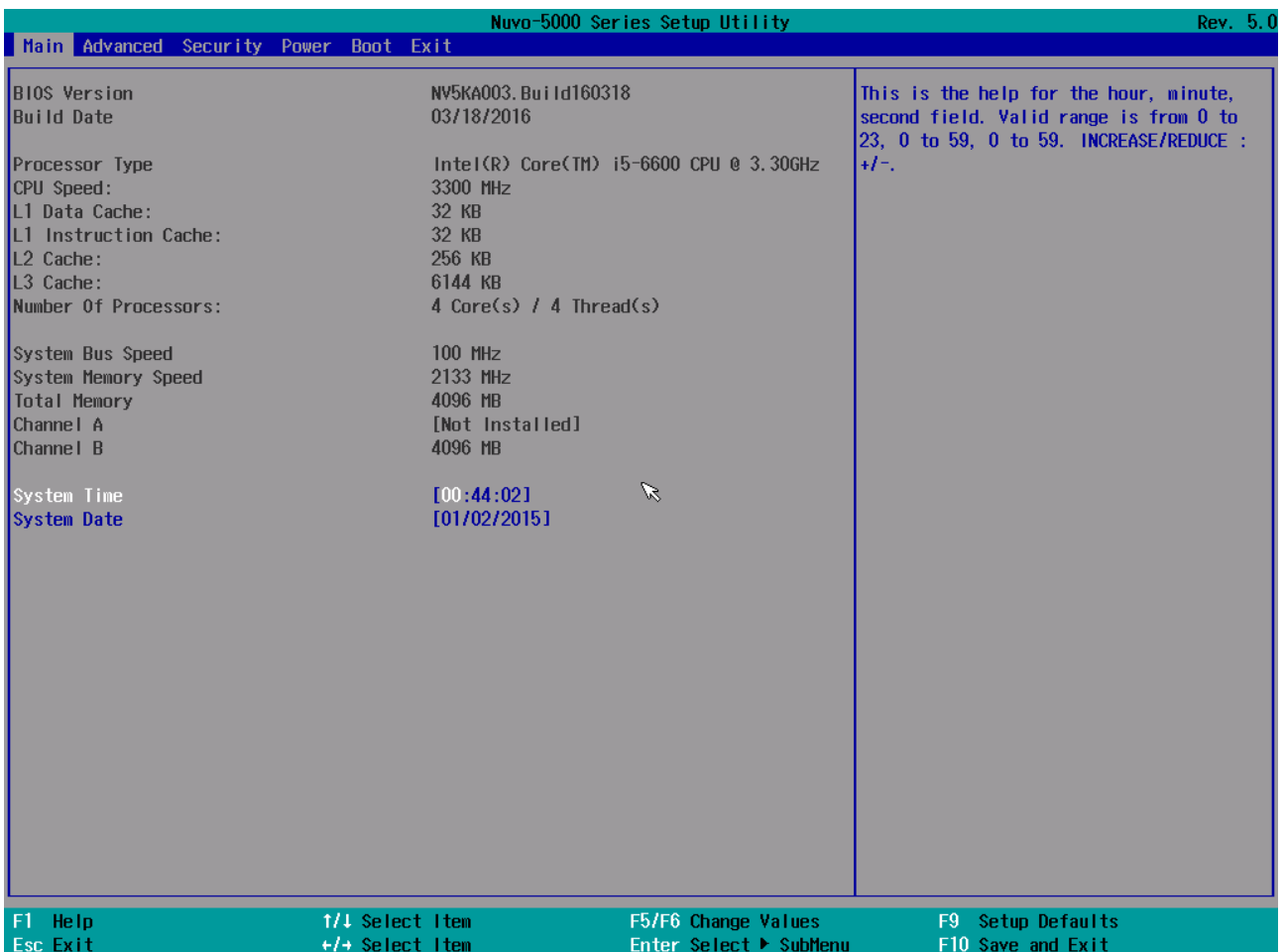

4.1.1 COM Port Configuration

There are totally five COM ports implemented on Nuvo-5000 series. COM1, COM2 and COM3 are located on the back panel. COM4 and COM5 are internally used for Mezio™ interface.

COM1 and COM3 of Nuvo-5000 series support RS-232 (full-duplex), RS-422 (full-duplex) and RS-485 (half-duplex) mode, while COM2 supports RS-232 mode only. You can set the operating mode of COM1/COM3 via BIOS settings. Another option in BIOS, “**Slew Rate**”, defines how sharp the rising/falling edge is for the output signal of COM1/COM3. For long-distance RS-422/485 transmission, you may set the “**Slew Rate**” option as “High” to improve signal integrity. For RS-422/485 communication, the “**RS-422/485 Termination**” option determines whether to enable/disable internal termination of RS-422/485 transceiver according to your wiring configuration (e.g. with or without external termination).

To configure COM1/COM3 operating mode:

1. When Nuvo-5000 controller boots up, press F2 to enter BIOS setup utility.
2. Go to **[Advanced]** → **[Peripheral Configuration]**.
3. Set the **[Set COM1 as]** to a proper mode for COM1 of your Nuvo-5000 controller.
4. Set the **[Set COM3 as]** to a proper mode for COM3 of your Nuvo-5000 controller.

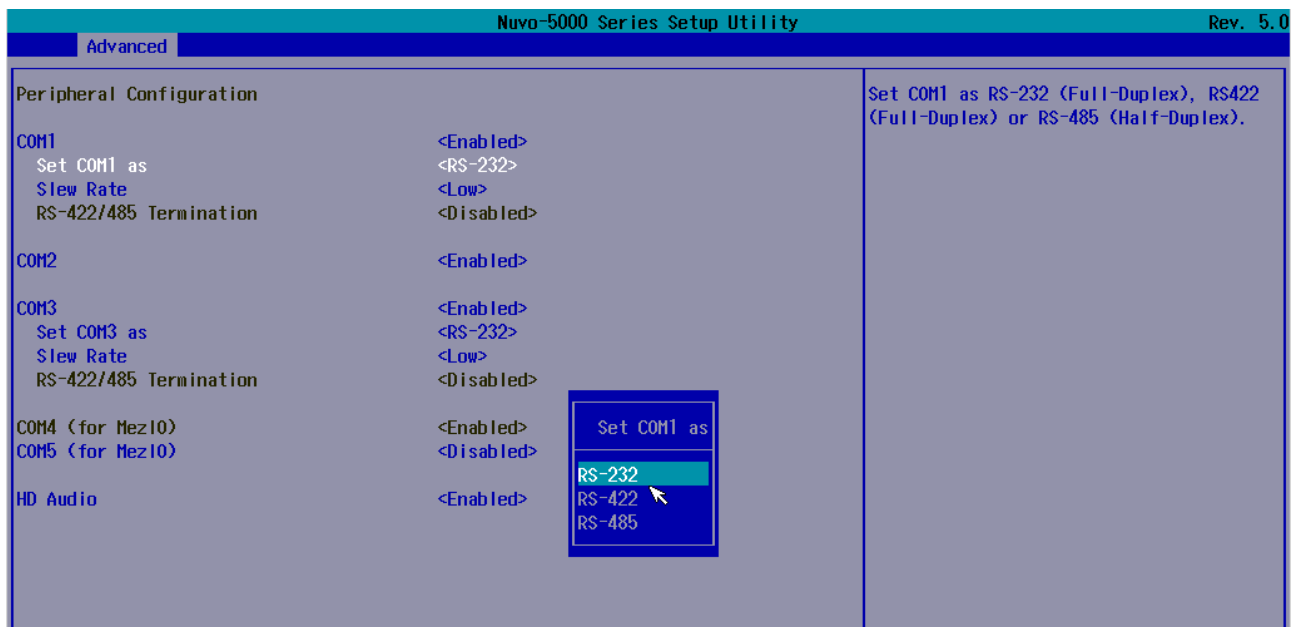

4.1.2 SATA Port Configuration

The SATA controller of Nuvo-5000 series supports two operating modes: **AHCI** and **RAID** mode. **AHCI** mode, which exposes SATA's advanced capabilities such as hot swapping and native command queuing, is supported in most of modern operating systems. **RAID** mode provides a more reliable data storage (RAID 1/5/10) or a higher disk access throughput (RAID 0/5/10).

The RAID feature is built in Intel Q170 chipset with BIOS support. No additional H/W or driver is needed to use RAID function. You can configure the RAID volume during BIOS POST. Please refer to section 4.3 for detail.

To configure SATA controller operating mode:

1. When Nuvo-5000 controller boots up, press F2 to enter BIOS setup utility.
2. Go to **[Advanced]** → **[SATA Configuration]**.
3. Set the **[SATA Mode Selection]** to a proper mode for your Nuvo-5000 controller.

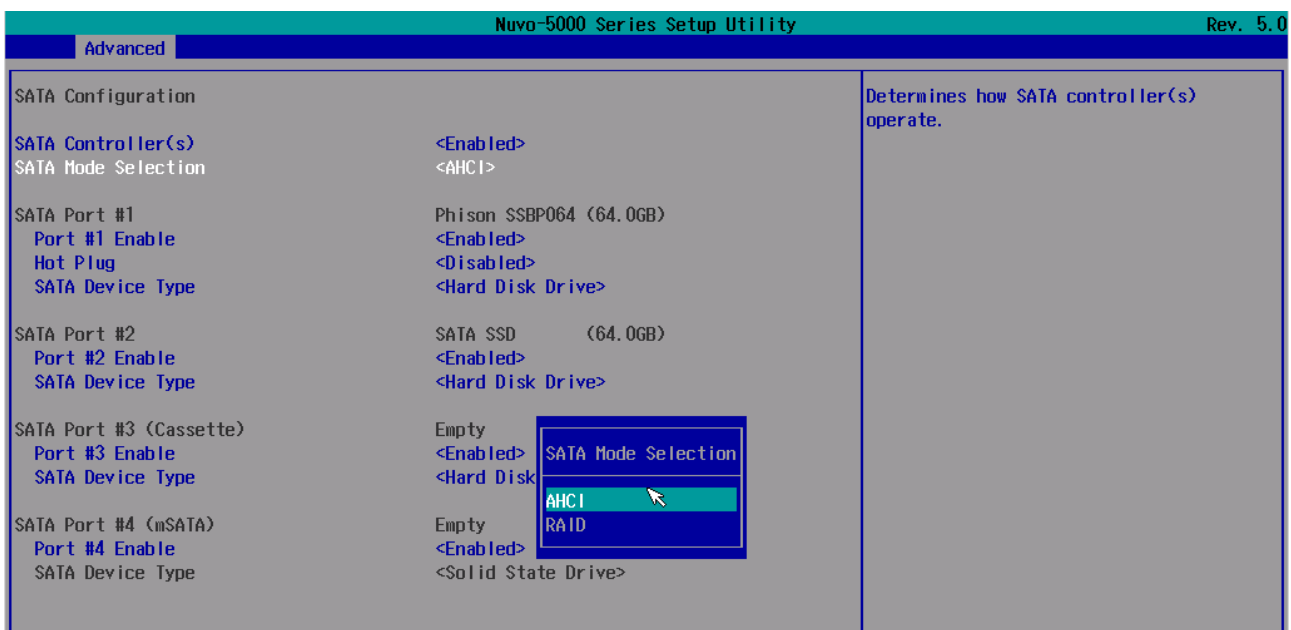

4.1.3 Hot Plug for SATA Port #1

On Nuvo-5006LP and Nuvo-5002LP, SATA port #1 is connected to a panel-accessible HDD tray which supports hot-swap feature. You can simply eject the HDD and replace it with another one without turning off the system. By default, hot plug for SATA port # 1 is disabled in BIOS, you need to enable it in prior to support the hot-swap feature.

To enable hot plug for SATA port #1:

1. When Nuvo-5000 controller boots up, press F2 to enter BIOS setup utility.
2. Go to **[Advanced]** → **[SATA Configuration]**.
3. Enable the **[Hot Plug]** option for SATA port #1 to support hot-swap feature.

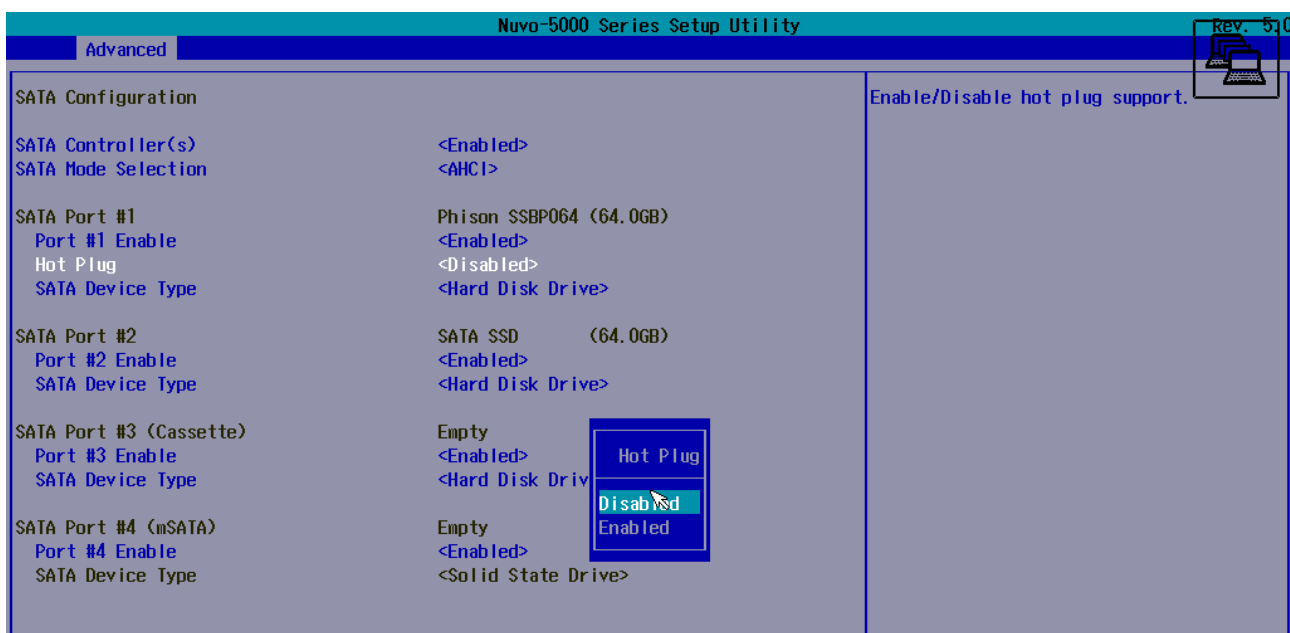

4.1.4 Enable TPM Feature

TPM, or Trusted Platform Module, is a hardware-based cryptoprocessor to secure hardware by integrating cryptographic keys into devices. Nuvo-5000 series is designed with on-board TPM 2.0 module. As TPM 2.0 requires 64-bit Windows 7/8/10 with UEFI boot mode, it is disabled in BIOS by default. For customers who want to utilize TPM feature, you shall enable TPM in BIOS as well as install Windows with UEFI mode.

To enable TPM 2.0 feature:

1. When Nuvo-5000 controller boots up, press F2 to enter BIOS setup utility.
2. Go to **[Security]**.
3. Enable TPM by selecting “**Available**” for **[TPM Availability]** option.
4. You will also need to select UEFI boot mode for installing Windows. Please refer to section 4.1.8 for detail.

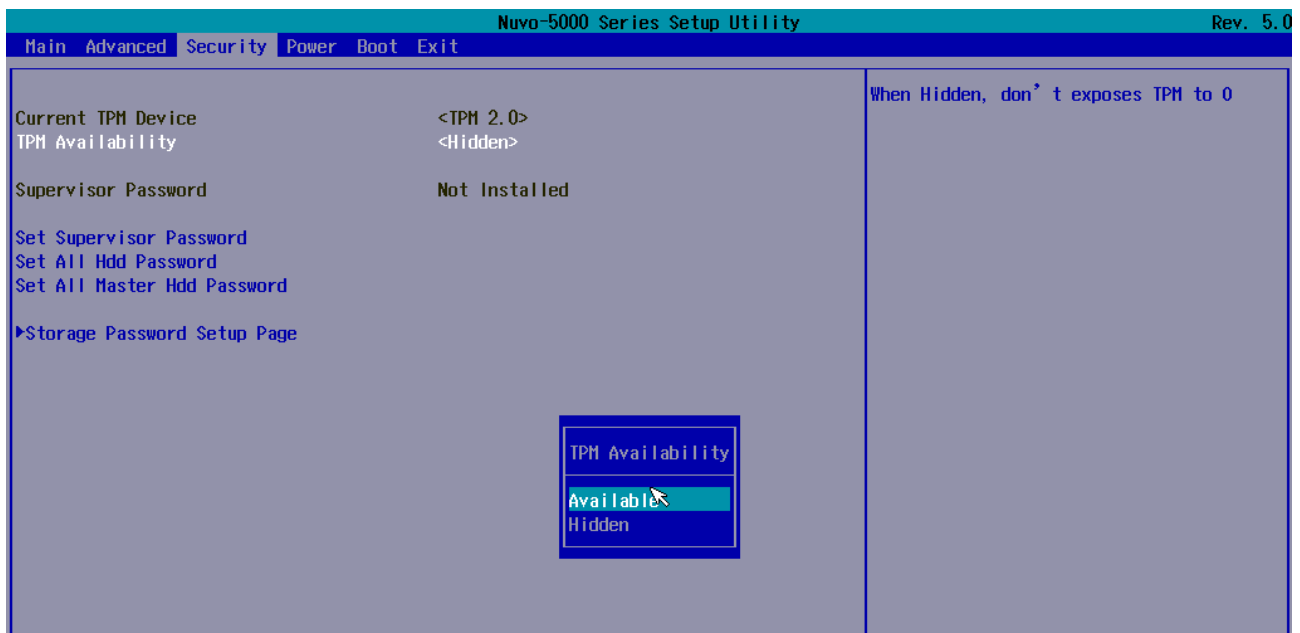

4.1.5 Configure CPU SKU Power

Nuvo-5000 series supports a long list of 6th-gen Skylake LGA1151 CPU with up to 65W TDP. A unique feature, “**SKU Power Config**” is implemented in BIOS to allow users to specify user-defined SKU power limit for installed CPU according to deployment environment and power budget. For example, if a Nuvo-5000 controller with 65W i7-6700 CPU installed is deployed in the environment of 60°C ambient temperature, you can limit the CPU to run with up to 45W TDP. This feature gives you the flexibility of CPU selection and great balance between computing power and operating temperature range.

Here is our suggestion regarding specifying SKU power for system with 65W/54W/51W CPU.

- For system running at up to 70°C ambient, specify SKU power to 35 W.
- For system running at up to 60°C ambient, specify SKU power to 45 W..
- For system running at up to 50°C ambient, specify SKU power to Max. TDP.

To configure the CPU SKU power limit:

1. When Nuvo-5000 controller boots up, press F2 to enter BIOS setup utility.
2. Go to **[Power]** → **[Power & Performance]**.
3. Select a proper value of SKU power limit for **[SKU Power Config]** option.

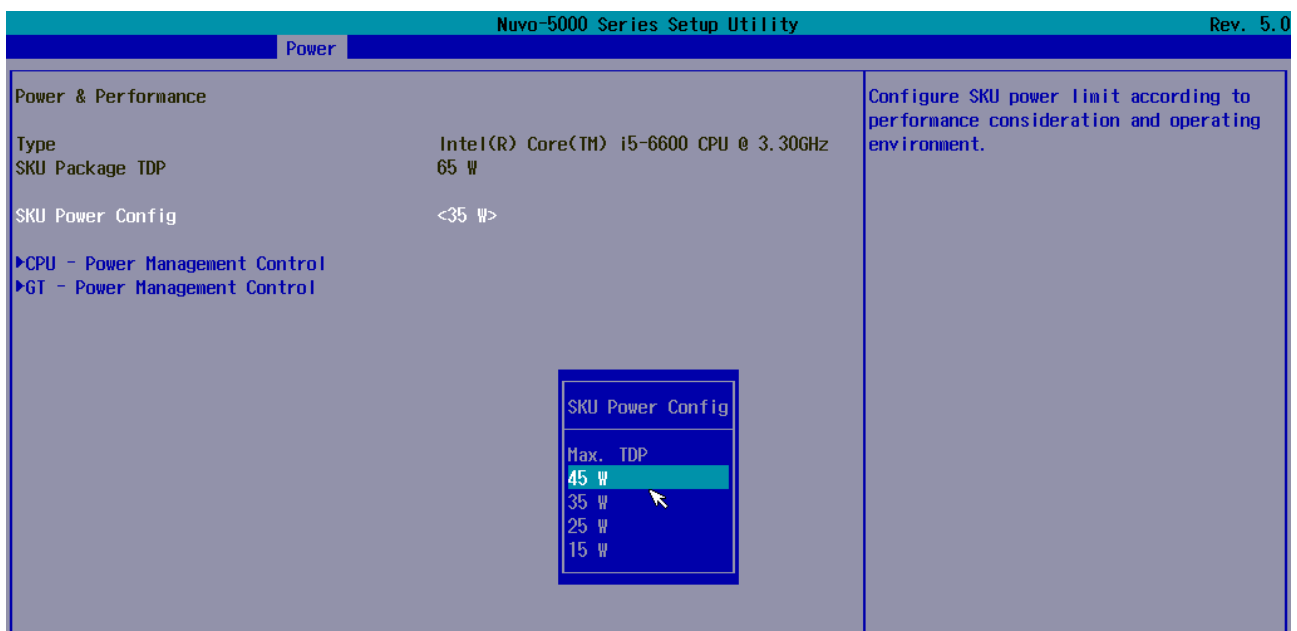

4.1.6 Wake-on-LAN Option

Wake-on-LAN (WOL) is a mechanism which allows you to turn on your Nuvo-5000 controller via Ethernet connection. To utilize Wake-on-LAN function, you need to enable this option first in BIOS settings. Please refer to section 3.10.3 for instructions of using WOL function.

To enable/disable "Wake on LAN" option:

1. When Nuvo-5000 controller boots up, press F2 to enter BIOS setup utility.
2. Go to **[Power]**.
3. Enable/disable the **[Wake on LAN]** option according to your application.



4.1.7 Power On after Power Failure Option

The “Power On after Power Failure” option defines the behavior of Nuvo-5000 controller when DC power is supplied.

Value	Description
S0 – Power On	System is powered on when DC power is supplied.
S5 – Power Off	System is kept in off state when DC power is supplied.

To set “Power On after Power Failure” option:

1. When Nuvo-5000 controller boots up, press F2 to enter BIOS setup utility.
2. Go to **[Power]**.
3. Set the **[Power On after Power Failure]** option to a proper value for your Nuvo-5000 controller.

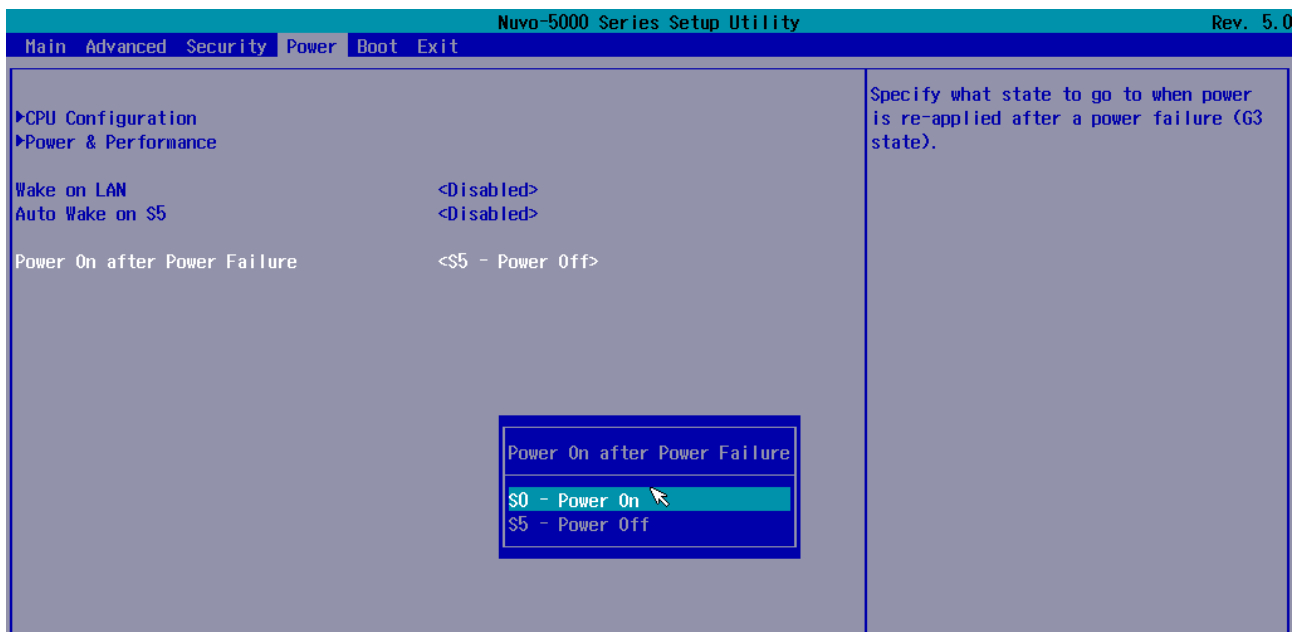

4.1.8 Configure Legacy/UEFI Boot Type

Nuvo-5000 series supports both legacy and UEFI boot mode. UEFI, or Unified Extensible Firmware Interface, is a specification proposed by Intel to define a software interface between operating system and platform firmware. Most modern operating systems, such as Windows 7/8/10 and Linux, support both legacy and UEFI boot mode. Compared to that legacy boot uses MBR partition for disk and VBIOS for video initialization, UEFI boot uses GPT partition which supports > 2TB partition size and GOP driver for faster video initialization.

Here is our suggestion of choosing legacy boot or UEFI boot for your system.

- If you need > 2TB disk partition or want to use TPM 2.0 function, you shall choose UEFI boot mode and install operating system accordingly.
- Otherwise you can choose legacy boot mode for most cases.

To configure legacy or UEFI boot type:

1. When Nuvo-5000 controller boots up, press F2 to enter BIOS setup utility.
2. Go to **[Boot]**.
3. Set the **[Boot Type]** option to a proper value for your Nuvo-5000 controller.

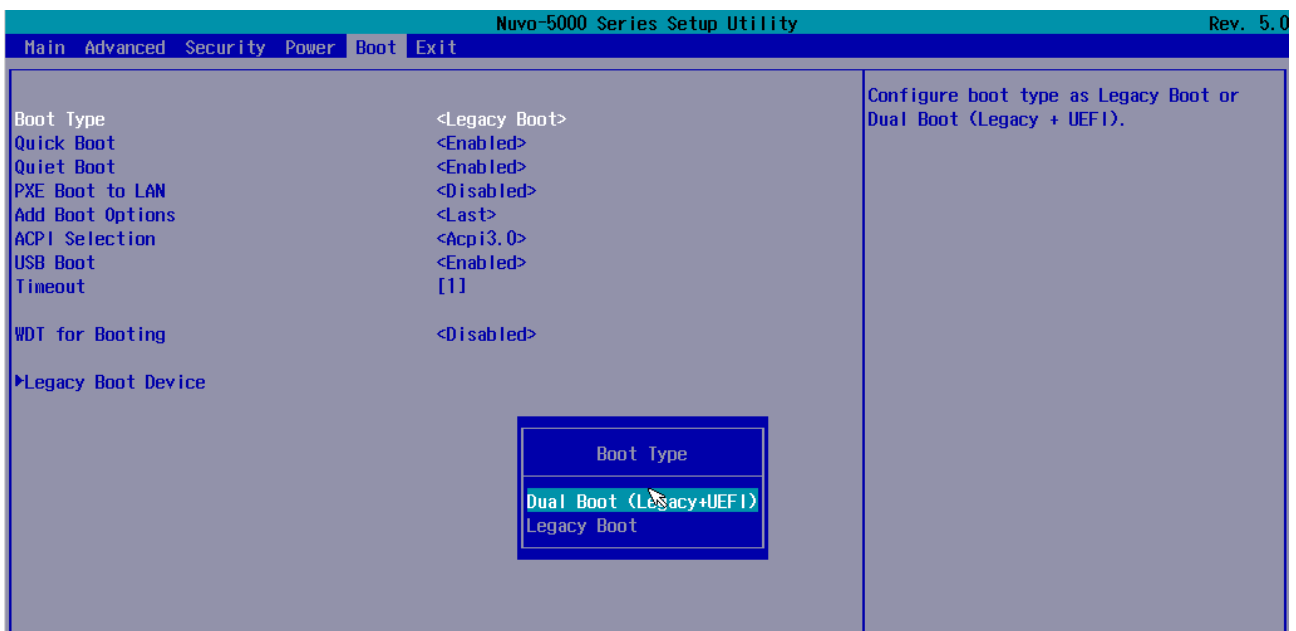

4.1.9 Position New Boot Device

When you plug a newly-installed boot device (e.g. USB flash disk), this option allow you determine whether to place the new boot device in the first place or the last place in the boot sequence.

1. When Nuvo-5000 controller boots up, press F2 to enter BIOS setup utility.
2. Go to **[Boot]** menu.
3. The **[Add New Boot Device]** option decides whether to place the newly-installed boot device to the “**First**” place or the “**Last**” place in the boot sequence.

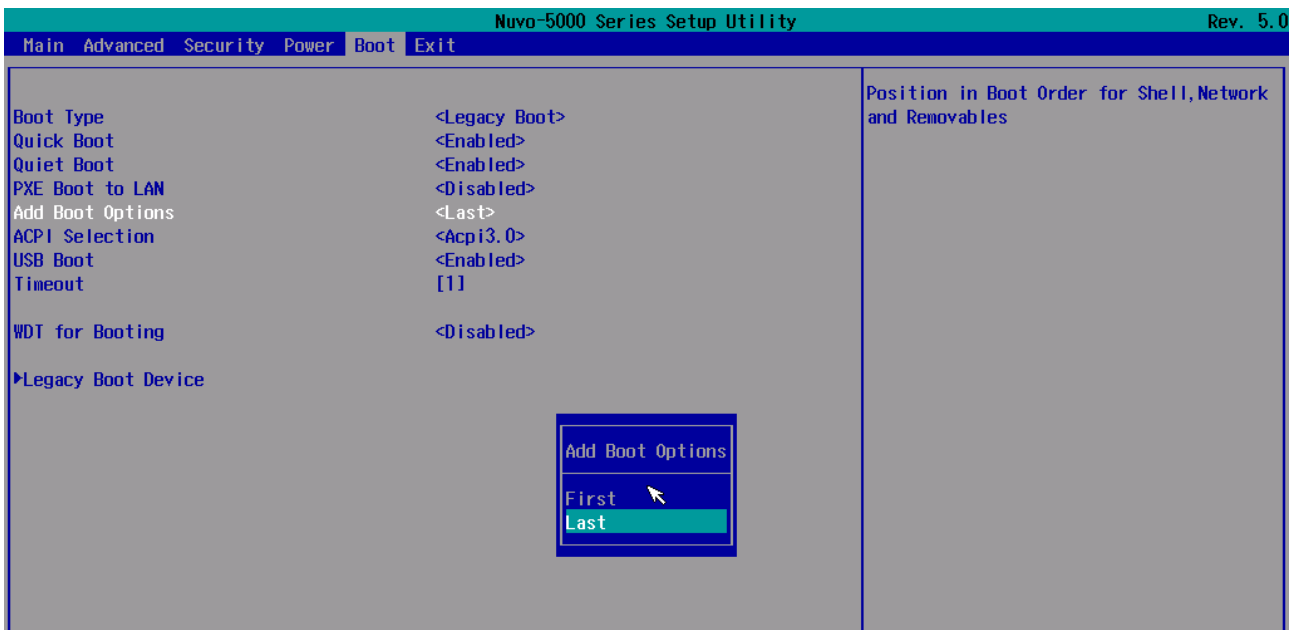

4.1.10 Watchdog Timer for Booting

The BIOS of Nuvo-5000 series has a useful feature which allows users to use the watchdog timer to secure the booting process. You can specify the timeout value for watchdog timer. Once the watchdog timer expires, the BIOS issues a reset command to initiate another booting process. You can also set the behavior of how to stop the watchdog timer. There are two options in BIOS menu, “**Automatically after POST**” and “**Manually after Entering OS**”. When “**Automatically after POST**” is selected, the BIOS automatically stop the watchdog timer after POST (Power-On Self Test) OK. When “**Manually after Entering OS**” is selected, it's user's liability to stop the watchdog timer when entering OS. This guarantees the system can always boot to OS, otherwise another booting process will be initiated. For information about programming watchdog timer, please refer to **Appendix B Using Watchdog Timer**.

To set the watchdog timer for boot in BIOS:

1. When Nuvo-5000 controller boots up, press F2 to enter BIOS setup utility.
2. Go to **[Boot]** menu.
3. Disable or select timeout value for **[WDT for Booting]** option.
4. Once you give a timeout value, the **[WDT Stop Option]** option appears. You can select “**Automatically after POST**” or “**Manually after Entering OS**”.

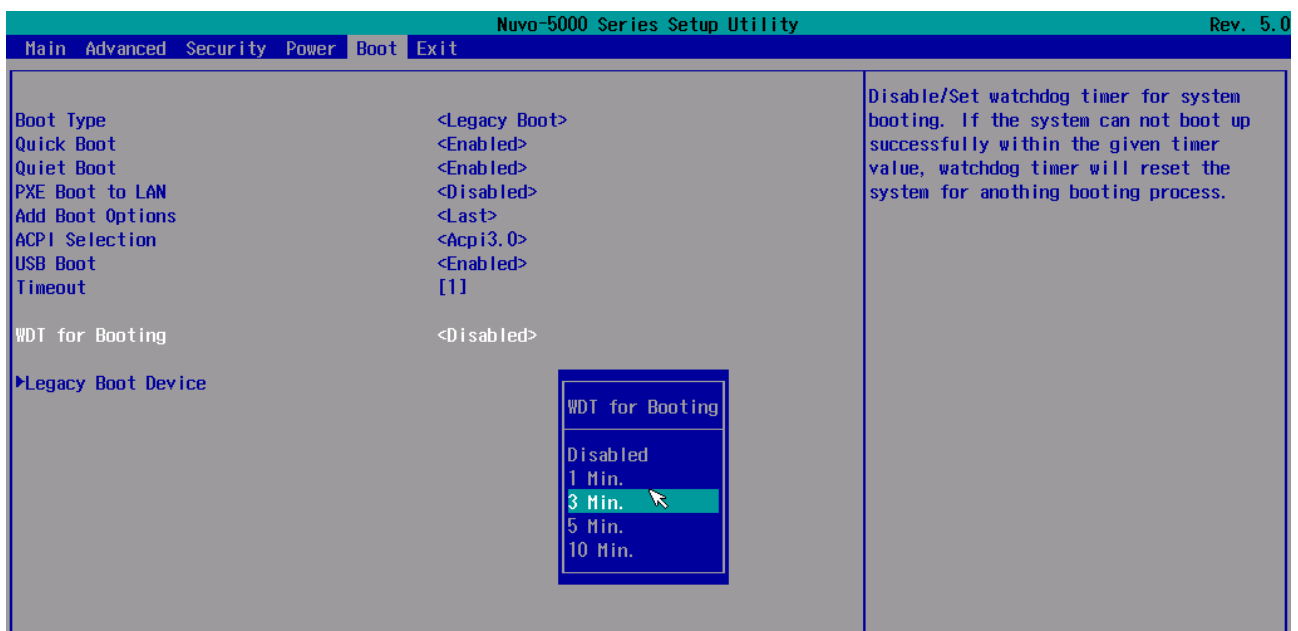

Nuvo-5000 Series Setup Utility Rev. 5.0

Main Advanced Security Power **Boot** Exit

Boot Type	<Legacy Boot>	Select when and how to to stop watchdog timer. If [Automatically after POST] is selected, watchdog timer is stopped automatically after BIOS POST. If [Manually after Entering OS] is selected, it's user's responsibility to stop watchdog timer after entering OS.
Quick Boot	<Enabled>	
Quiet Boot	<Enabled>	
PXE Boot to LAN	<Disabled>	
Add Boot Options	<Last>	
ACPI Selection	<Acpi3.0>	
USB Boot	<Enabled>	
Timeout	[1]	
WDT for Booting	<3 Min.>	
WDT Stop Option	<Automatically after POST>	

►Legacy Boot Device

WDT Stop Option

Automatically after POST

Manually after Entering OS



4.1.11 Select a Boot Device

When you have multiple bootable devices connected to your Nuvo-5000 controller (e.g. HDD, mSATA, USB flash disk, USB DVD-drive), you may need to select one of them as the boot device. There are two ways to select the device. You can either, press F12 when system boots up to go to Boot Manager and then select one of the devices, or select the boot device in BIOS settings.

To select a boot device in UEFI boot mode:

1. When Nuvo-5000 controller boots up, press F2 to enter BIOS setup utility.
2. Go to **[Boot] → [UEFI Boot Device]**.
3. Use F5/F6 or +/- to change the order of UEFI boot devices.

To select a boot device in legacy boot mode:

1. When Nuvo-5000 controller boots up, press F2 to enter BIOS setup utility.
2. Go to **[Boot] → [Legacy Boot Device]**.
3. The **[Boot Menu]** option decides whether to list all bootable devices connected to your Nuvo-5000 controller according to **[By Device]** or **[By Device Type]**. You can use F5/F6 or +/- to change the boot order of devices or device categories.

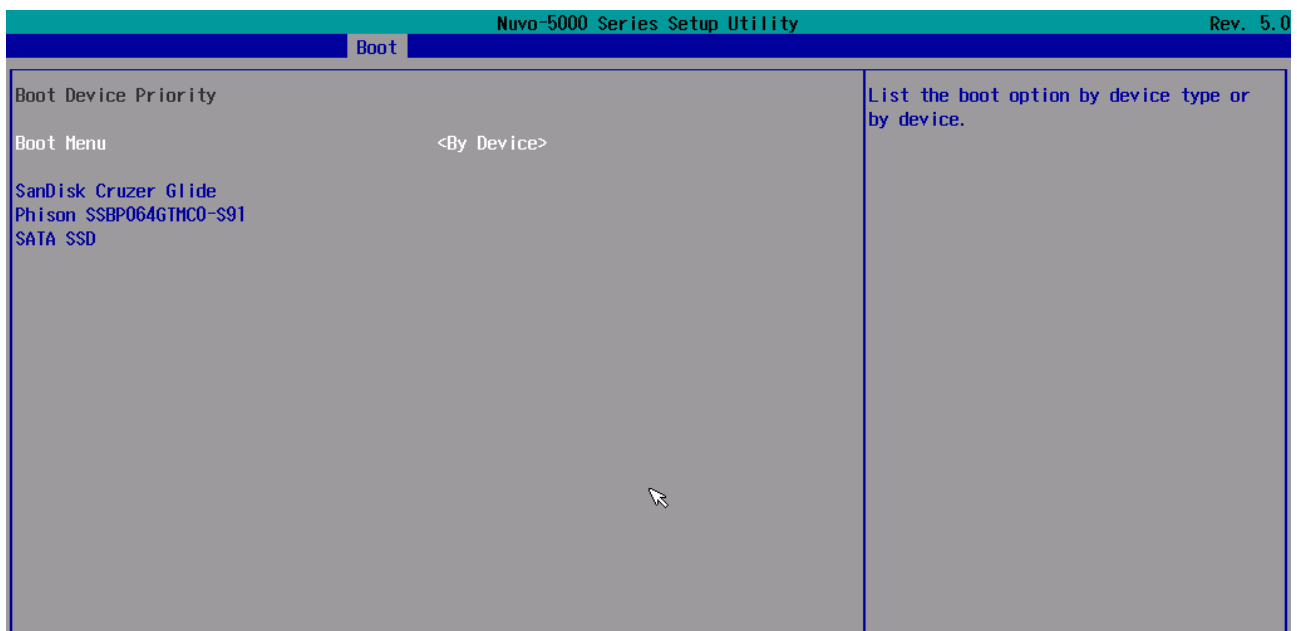

4.2 Configure AMT

Intel® AMT (Active Management Technology) is a hardware-based technology for remotely managing target PCs via Ethernet connection. Nuvo-5000 series supports AMT function via its Ethernet port implemented with Intel I219-LM. In prior to use AMT to remotely control Nuvo-5000 series, you need to configure AMT password and network settings.

1. Make sure you have Ethernet connection on the Ethernet port implemented via I219-LM of Nuvo-5000 series.



2. Press F10 when Nuvo-5000 controller boots up. A MEBx configuration page appears.

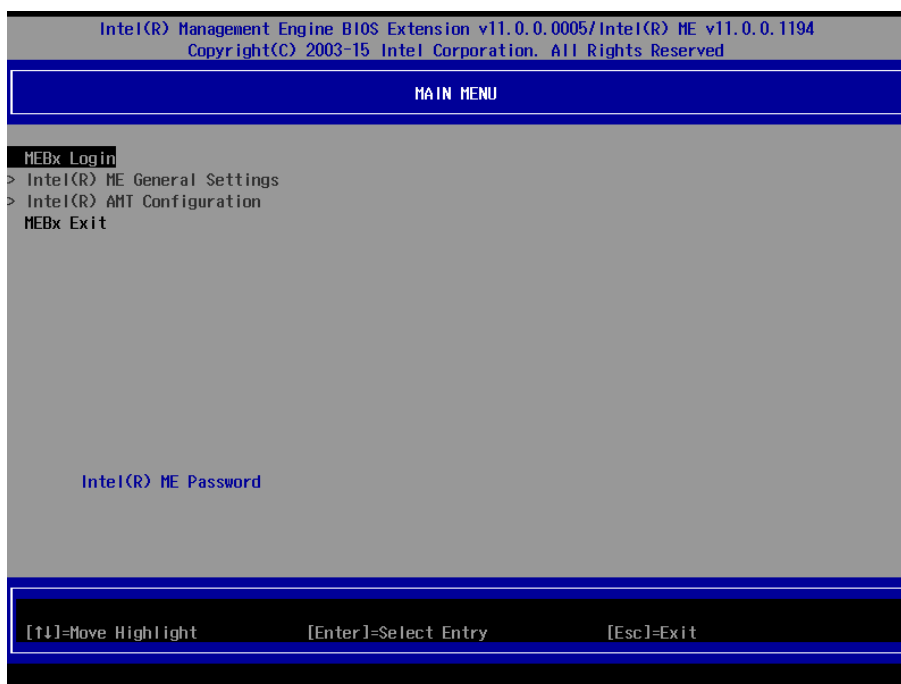

3. Select "MEBx Login" and you're asked for password. The default password is "admin". For further MEBx configuration, please refer to Intel® MEBX User Guide. You can find related information at

<http://www.intel.com/support/motherboards/desktop/sb/CS-033768.htm>

4.3 Configure RAID Volume

Nuvo-5000 series supports hardware RAID function for more reliable and efficient disk access. The built-in RAID supports RAID 0 (data striping), RAID 1 (data mirroring), RAID 5 (data striping + parity) and RAID 10 (data striping + mirroring). You can configure RAID mode according to your application by following steps listed below.

1. Make sure you've configured SATA controller to **RAID** mode (refer to section 4.1.2 for further information).
2. Reboot Nuvo-5000 controller, you will see a UI banner for RAID configuration.

```
Intel(R) Rapid Storage Technology - Option ROM - 14.0.0.2234
Copyright (C) Intel Corporation. All rights reserved.

RAID Volumes:
None defined.

Physical Devices:
ID   Device Model      Serial #           Size Type/Status(Vol ID)
2   Phison SSBP064GT  0757176400019671 59.6GB Non-RAID Disk
3   SATA SSD          073A092C00041319 59.6GB Non-RAID Disk
Press <CTRL-I> to enter Configuration Utility...
```

3. Press <CTRL-I> to enter RAID configuration page. You can create, delete or configure your RAID volume here.

```
Intel(R) Rapid Storage Technology - Option ROM - 14.0.0.2234
Copyright (C) Intel Corporation. All rights reserved.

[ MAIN MENU ]
1. Create RAID Volume          4. Recovery Volume Options
2. Delete RAID Volume         5. Acceleration Options
3. Reset Disks to Non-RAID    6. Exit
[ DISK/VOLUME INFORMATION ]

RAID Volumes:
None defined.

Physical Devices:
ID   Device Model      Serial #           Size Type/Status(Vol ID)
2   Phison SSBP064GT  0757176400019671 59.6GB Non-RAID Disk
3   SATA SSD          073A092C00041319 59.6GB Non-RAID Disk

[↑↓]-Select      [ESC]-Exit      [ENTER]-Select Menu
```

4.4 Operating System Support

Nuvo-5000 series supports most modern operating systems developed for Intel® x86 architecture. The following list contains the operating systems which have been tested with Nuvo-5000 series in Neosys Technology Inc.

- Microsoft Window 7 32-bit*
- Microsoft Window 7 64-bit*
- Microsoft Window 8.1 64-bit
- Microsoft Windows 10 64-bit
- OpenSUSE 42.1**
- Fedora 23**
- Ubuntu 14.04.4 LTS and 16.04 LTS**
- Debian 8.3**

* *Due to the nature that XHCI driver is not included natively in Windows 7, you may encounter the issue of USB keyboard/mouse not working when installing Windows 7. Neosys offers a Windows-based batch file and step-by-step guide to help you. Please refer to Appendix A for information of installing Windows 7 on Nuvo-5000.*

** *For some Linux distributions, graphics driver and RAID function may not be completely implemented in its kernel. You may encounter restrictions when using these features, such as triple independent display and RAID. It should be user's liability to manually upgrade related drivers if necessary.*

Neosys will keep this list updated as we continuously test other operating systems with Nuvo-5000 series. Please contact us for the latest OS support list.



4.5 Driver Installation

Neosys provides a very convenient utility in “Drivers & Utilities DVD” to allow the “One-Click” driver installation. This utility automatically detects your Windows operating system and installs all necessary drivers to your Nuvo-5000 controller with just one mouse click.

4.5.1 Install All Drivers Using “One-Click” Driver Installation

1. Insert the “Drivers & Utilities DVD” into a USB DVD-drive attached to your Nuvo-5000 series. A setup utility launches and the following dialog appears.



2. Click on the “**Automatic Driver Installation**”. The setup utility will automatically detect your Windows operating system and install all necessary drivers. According to different versions of Windows, the installation process takes about 6~8 minutes. Once driver installation is done, the setup utility reboots your Windows and your system works normally afterward.

4.5.2 Install Drivers Manually

You can also manually install each driver for Nuvo-5000 series. Please refer to the following information about installing drivers for different operating system.

Windows 7 32-bit

The recommended driver installation sequence is

1. Chipset driver (x:\Driver_Pool\Chipset_10_Series\Win_ALL\SetupChipset.exe)
2. Graphics driver (x:\Driver_Pool\Graphics_6th_i7\Win_7_32\Setup.exe)
3. Audio driver (x:\Driver_Pool\Audio_ALC262\Win_ALL_32\Setup.exe)
4. LAN driver
(x:\Driver_Pool\GbE_I210_I350\Win_ALL_32\APPS\PROSETDX\Win32\DxSetup.exe)
5. ME driver (x:\Driver_Pool\ME_10_Series\Win_ALL_AMT\SetupME.exe)

Windows 7 64-bit

The recommended driver installation sequence is

1. Chipset driver (x:\Driver_Pool\Chipset_10_Series\Win_ALL\SetupChipset.exe)
2. Graphics driver (x:\Driver_Pool\Graphics_6th_i7\Win_7_8_10_64\Setup.exe)
3. Audio driver (x:\Driver_Pool\Audio_ALC262\Win_ALL_64\Setup.exe)
4. LAN driver
(x:\Driver_Pool\GbE_I210_I350\Win_ALL_64\APPS\PROSETDX\Winx64\DxSetup.exe)
5. TPM 2.0 driver (x:\Driver_Pool\TPM2\Win7_64\Windows6.1-KB2920188-v7-x64.msu)
6. ME driver (x:\Driver_Pool\ME_10_Series\Win_ALL_AMT\SetupME.exe)

Windows 8/8.1 64-bit

The recommended driver installation sequence is

1. Chipset driver (x:\Driver_Pool\Chipset_10_Series\Win_ALL\SetupChipset.exe)
2. Graphics driver (x:\Driver_Pool\Graphics_6th_i7\Win_7_8_10_64\Setup.exe)
3. Audio driver (x:\Driver_Pool\Audio_ALC262\Win_ALL_64\Setup.exe)
4. LAN driver
(x:\Driver_Pool\GbE_I210_I350\Win_ALL_64\APPS\PROSETDX\Winx64\DxSetup.exe)
5. ME driver (x:\Driver_Pool\ME_10_Series\Win_ALL_AMT\SetupME.exe)

Windows 10 64-bit

The recommended driver installation sequence is

1. Chipset driver (x:\Driver_Pool\Chipset_10_Series\Win_ALL\SetupChipset.exe)
2. Graphics driver (x:\Driver_Pool\Graphics_6th_i7\Win_7_8_10_64\Setup.exe)
3. Audio driver (x:\Driver_Pool\Audio_ALC262\Win_ALL_64\Setup.exe)



4. LAN driver
(x:\Driver_Pool\GbE_I210_I350\Win_ALL_64\APPS\PROSETDX\Winx64\DxSetup.exe)
5. ME driver (x:\Driver_Pool\ME_10_Series\Win_ALL_AMT\SetupME.exe)



4.5.3 Install Driver for WDT and Per-port PoE On/Off Control

Neosys provides a driver package which contain function APIs for WDT and per-port PoE power on/off control function. You should install the driver package (WDT_DIO_Setup.exe) in prior to use these functions. Please note that you must install WDT_DIO_Setup_v2.2.2 or later revision for Nuvo-5000 series.

Windows 7 32-bit

Please execute the driver setup program in the following directory.

x:\Driver_Pool\WDT_DIO\XP_Win7_8_32\WDT_DIO_Setup_v2.2.2.exe

Windows 7/8/10 64-bit (x64)

Please execute the driver setup program in the following directory.

x:\Driver_Pool\WDT_DIO\Win7_8_64\WDT_DIO_Setup_v2.2.2(x64).exe

Windows 7/8/10 64-bit (WOW64)

Please execute the driver setup program in the following directory.

x:\Driver_Pool\WDT_DIO\Win7_8_WOW64\WDT_DIO_Setup_v2.2.2(wow64).exe

Appendix A Install Windows 7 on Nuvo-5000

Intel Skylake platform removes EHCI controller and supports USB 2.0 and USB 3.0 connectivity only through its xHCI controller. For Windows 8/8.1 and Windows10, no issue is anticipated due to native xHCI support in the OS. However, Windows 7 does not natively support xHCI thus manual installation of Intel's xHCI driver is required to support both USB storage device and USB keyboard/mouse during the OS installation process.

To install Windows 7 on Nuvo-5000, the simplest way is to create a USB thumb drive with Windows 7 installation files and Intel xHCI driver included. Neosys provides a Windows-based batch file and step-by-step guide to help you. Please follow instructions in this section to install Windows 7 on your Nuvo-5000.

A.1 Before We Start ...

Before we proceed with the creation of USB flash drive installer, please make sure you have the following items.

1. Windows 7 original installation DVD
2. USB thumb drive with at least 4 GB capacity
3. Software utility to create ISO image from DVD, e.g.
 - ImgBurn (<http://www.imgburn.com>)
 - Nero (<http://www.nero.com>)
4. Software utility to create bootable USB drive from ISO file, e.g.
 - Microsoft Windows USB/DVD Download Tool (<https://www.microsoft.com/en-us/download/windows-usb-dvd-download-tool>)
 - ISO to USB (<http://www.isotousb.com>)
5. You should have at least 10 GB disk space on your local drive.

A.2 Create USB Flash Drive Installer Step-by-Step

Step 1 - Create .ISO file from Windows 7 DVD

The first step is to create a .iso file from the Windows 7 DVD. Here we use ImgBurn (<http://www.imgburn.com>) to create the .iso file and save it to local drive.



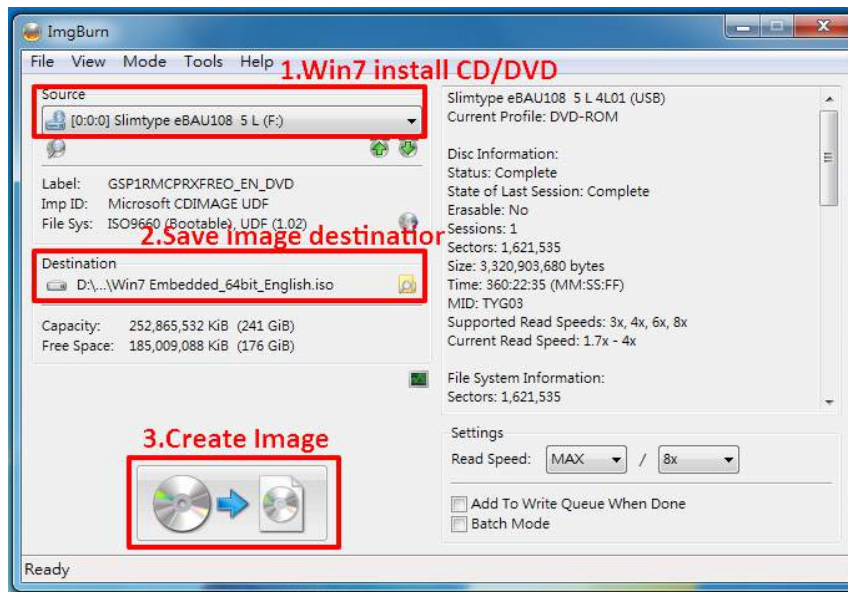

Step 2 - Create USB flash drive installer from .ISO

The next step is to create a bootable USB flash drive using the .iso file created in step 1. Here we use Microsoft Windows USB/DVD Download Tool to create the USB flash drive (<https://www.microsoft.com/en-us/download/windows-usb-dvd-download-tool>). Please note that the content of USB flash drive will be destroyed.

1. Right-click on the 'Windows 7 USB DVD Download Tool' and select 'Run as administrator'.
2. Follow the instructions below to create the USB flash drive installer.

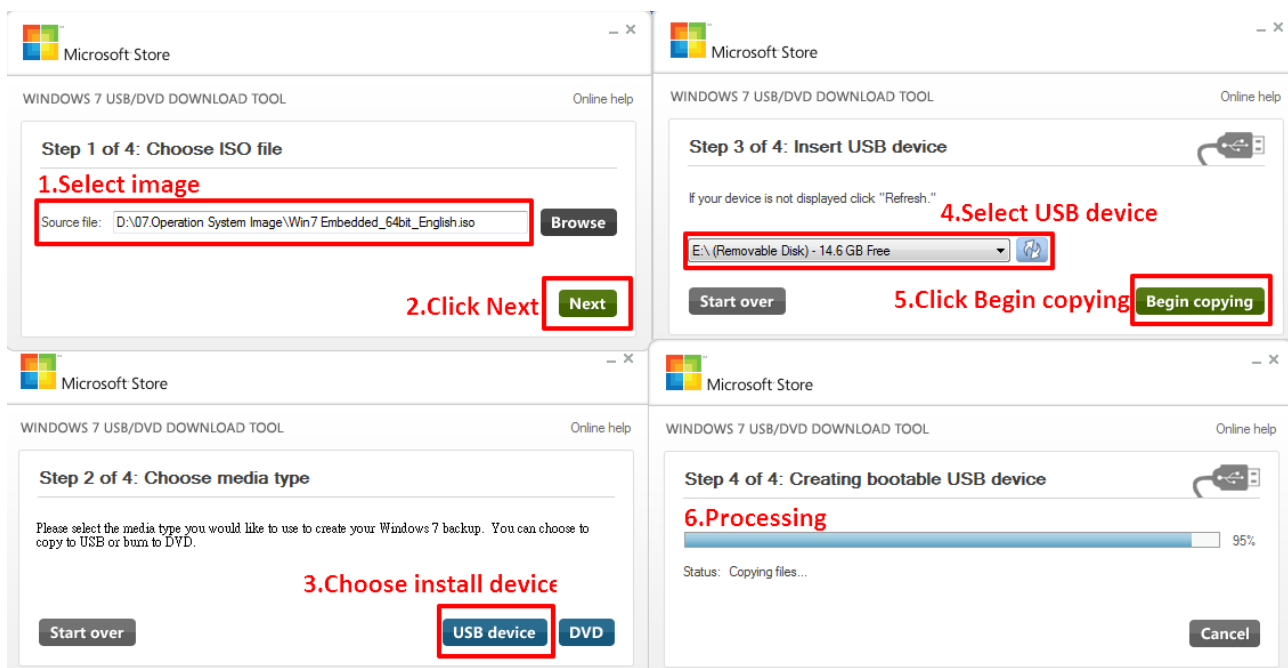

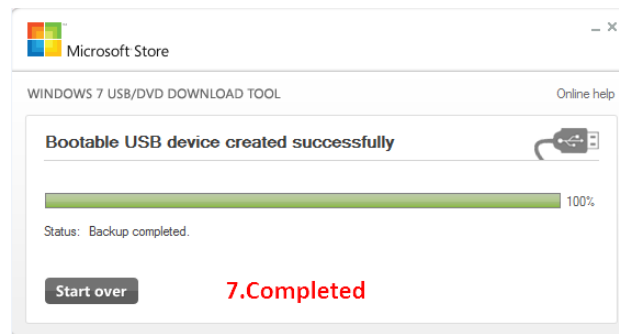

Step 3 - Create working folder on your local drive

In this step, we need to create a working folder on your local drive and copy necessary files to it. Please following the steps below.

1. Create a temporary working folder on your local drive. Here we use D:\WIM as an example.
2. Create another folder under D:\WIM for Intel xHCI driver files. Here we use \x86 for Win7 32-bit and \x64 for Win7 64-bit.
3. Copy xHCI driver files to the corresponding folder. You can find the driver files from Neousys Driver DVD.
 - For Win7 32-bit, copy all files from x:\Driver_Pool\USB3_10_Series\Win7_ALL\x86 to D:\WIM\x86
 - For Win7 64-bit, copy all files from x:\Driver_Pool\USB3_10_Series\Win7_ALL\x64 to D:\WIM\x64
 (where x: denotes the drive of your DVD drive)
4. Copy **install.wim** and **boot.wim** from \sources folder of your USB flash drive to D:\WIM.

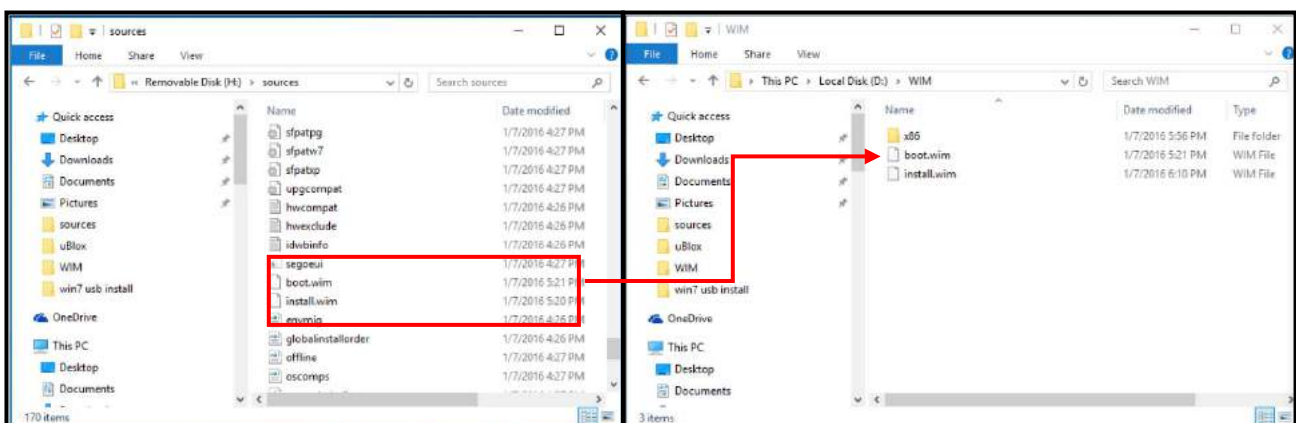

5. Copy the batch file (**Win7_USB3_Patch_x86.bat** or **Win7_USB3_Patch_x64.bat**) to D:\WIM. You can find the batch file in x:\Driver_Pool\USB3_10_Series\Win7_ALL.

Step 4 - Execute batch file to patch .wim files

To support xHCI for Windows 7 installation, both install.wim and boot.wim need to be patched to include xHCI driver files. Neosys offers Windows-based batch files (**Win7_USB3_Patch_x86.bat** for Windows 7 32-bit and **Win7_USB3_Patch_x64.bat** for Windows 7 64-bit) to simplify this process.

1. Before executing the batch file, please make sure folders specified in the batch file are identical to your working folders.

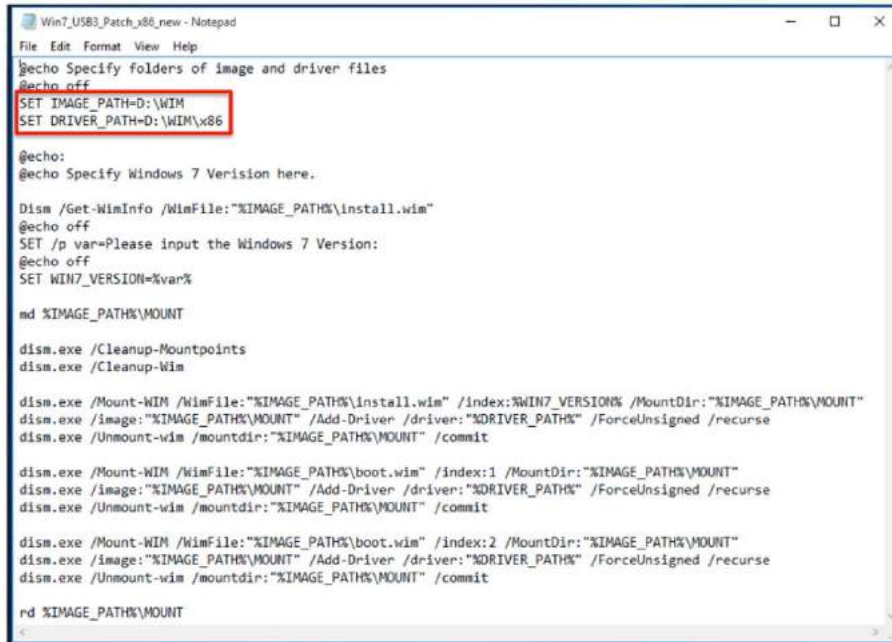

```

Win7_USB3_Patch_x86_new - Notepad
File Edit Format View Help
@echo Specify folders of image and driver files
@echo off
SET IMAGE_PATH=D:\WIM
SET DRIVER_PATH=D:\WIM\x86

@echo:
@echo Specify Windows 7 Verision here.

Dism /Get-WimInfo /WimFile:"%IMAGE_PATH%\install.wim"
@echo off
SET /p var=Please input the Windows 7 Version:
@echo off
SET WIN7_VERSION=%var%

md %IMAGE_PATH%\MOUNT

dism.exe /Cleanup-Mountpoints
dism.exe /Cleanup-Wim

dism.exe /Mount-WIM /WimFile:"%IMAGE_PATH%\install.wim" /index:%WIN7_VERSION% /MountDir:"%IMAGE_PATH%\MOUNT"
dism.exe /image:"%IMAGE_PATH%\MOUNT" /Add-Driver /driver:"%DRIVER_PATH%" /ForceUnsigned /recurse
dism.exe /Unmount-wim /mountdir:"%IMAGE_PATH%\MOUNT" /commit

dism.exe /Mount-WIM /WimFile:"%IMAGE_PATH%\boot.wim" /index:1 /MountDir:"%IMAGE_PATH%\MOUNT"
dism.exe /image:"%IMAGE_PATH%\MOUNT" /Add-Driver /driver:"%DRIVER_PATH%" /ForceUnsigned /recurse
dism.exe /Unmount-wim /mountdir:"%IMAGE_PATH%\MOUNT" /commit

dism.exe /Mount-WIM /WimFile:"%IMAGE_PATH%\boot.wim" /index:2 /MountDir:"%IMAGE_PATH%\MOUNT"
dism.exe /image:"%IMAGE_PATH%\MOUNT" /Add-Driver /driver:"%DRIVER_PATH%" /ForceUnsigned /recurse
dism.exe /Unmount-wim /mountdir:"%IMAGE_PATH%\MOUNT" /commit

rd %IMAGE_PATH%\MOUNT
  
```

2. Execute the batch file with administrator privilege. It appears an interactive menu for choosing Windows 7 edition. Please input the corresponding index number for your Windows 7 edition and press Enter.

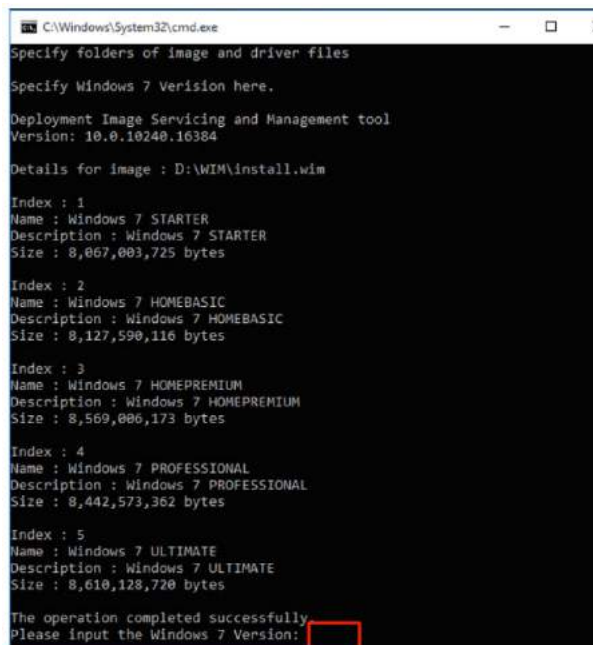

```

C:\Windows\System32\cmd.exe
Specify folders of image and driver files

Specify Windows 7 Verision here.

Deployment Image Servicing and Management tool
Version: 10.0.10240.16384

Details for image : D:\WIM\install.wim

Index : 1
Name : Windows 7 STARTER
Description : Windows 7 STARTER
Size : 8,067,003,725 bytes

Index : 2
Name : Windows 7 HOMEBASIC
Description : Windows 7 HOMEBASIC
Size : 8,127,590,116 bytes

Index : 3
Name : Windows 7 HOMEPREMIUM
Description : Windows 7 HOMEPREMIUM
Size : 8,569,006,173 bytes

Index : 4
Name : Windows 7 PROFESSIONAL
Description : Windows 7 PROFESSIONAL
Size : 8,442,573,362 bytes

Index : 5
Name : Windows 7 ULTIMATE
Description : Windows 7 ULTIMATE
Size : 8,610,128,720 bytes

The operation completed successfully.
Please input the Windows 7 Version:
  
```

- The batch file will automatically patch both install.wim and boot.wim. It takes few minutes to finish the patch process.
- Once patch finished, please overwrite the \sources\install.wim and \sources\boot.wim in USB flash drive installer with the patched ones.

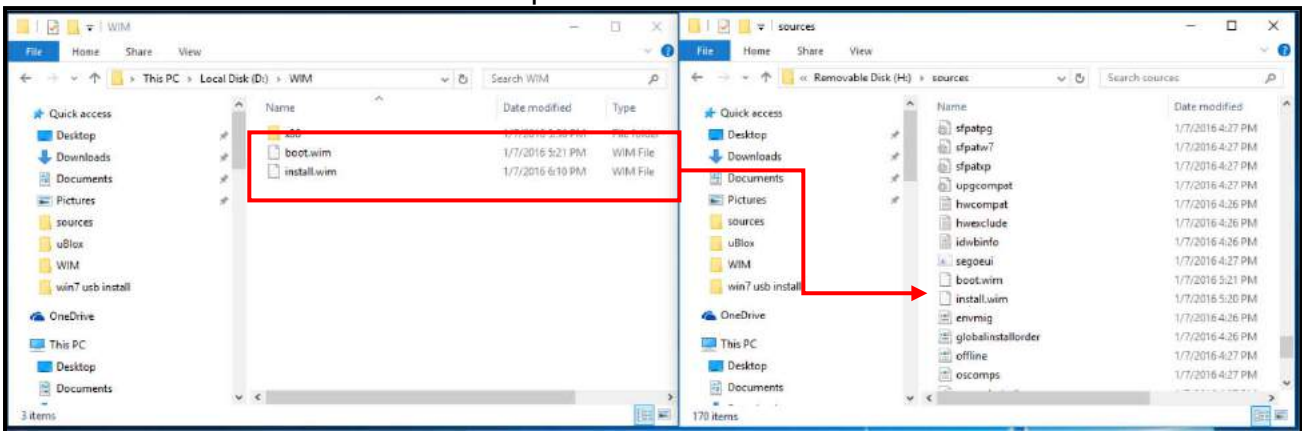

Step 5 - Install Windows 7 using USB flash drive installer

Now you can use the USB flash drive to install Windows 7 on your Nuvo-5000.

- Plug the USB flash drive to USB port of Nuvo-5000.
- Power on the system and press F12 to select USB flash drive as boot device.
- Follow regular installation process to install Windows 7 on your Nuvo-5000. The xHCI driver is included in the newly-installed system.

Note:

If it appears a warning message of “Setup was unable to create a new system partition or locate an existing system partition”, please to unplug and re-plug the USB flash drive, click ‘Refresh’ and try again.

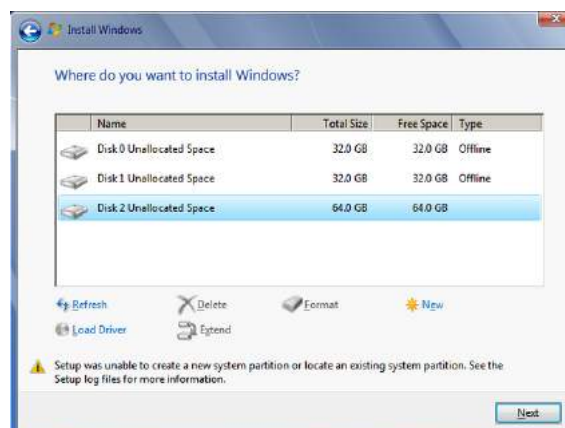

Appendix B Using Watchdog Timer

Nuvo-5000 series provides watchdog timer (WDT) function to ensure reliable system operation. The WDT is a hardware mechanism to reset the system if the watchdog timer is expired. Users can start the WDT and keeping resetting the timer to make sure the system or program is running. Otherwise, the system shall be reset.

In this section, we'll illustrate how to use the function library provided by Neosys to program the WDT functions. Currently, WDT driver library supports Windows 7/8.1/10 32-bit and 64-bit versions. For other OS support, please contact Neosys Technology for further information.

Install WDT_DIO Library

The WDT_DIO function library is delivered in the form of a setup package named **WDT_DIO_Setup.exe**. In prior to program WDT, you should execute the setup program and install the WDT library. Please use the following WDT_DIO_Setup packages according to your operating systems and applications on Nuvo-5000 series.

- For Windows 7/8.1/10 32-bit OS, please install WDT_DIO_Setup_v2.2.2.exe or later version.
- For Windows 7/8.1/10 64-bit OS with 64-bit application (x64 mode), please install WDT_DIO_Setup_v2.2.2(x64).exe or later version.
- For Windows 7/8.1/10 64-bit OS with 32-bit application (WOW64 mode), please install WDT_DIO_Setup_v2.2.2(wow64).exe or later version.



To install WDT_DIO_Setup package, please follow steps described below.

1. Execute **WDT_DIO_Setup.2.2.20.exe**. The following dialog appears.

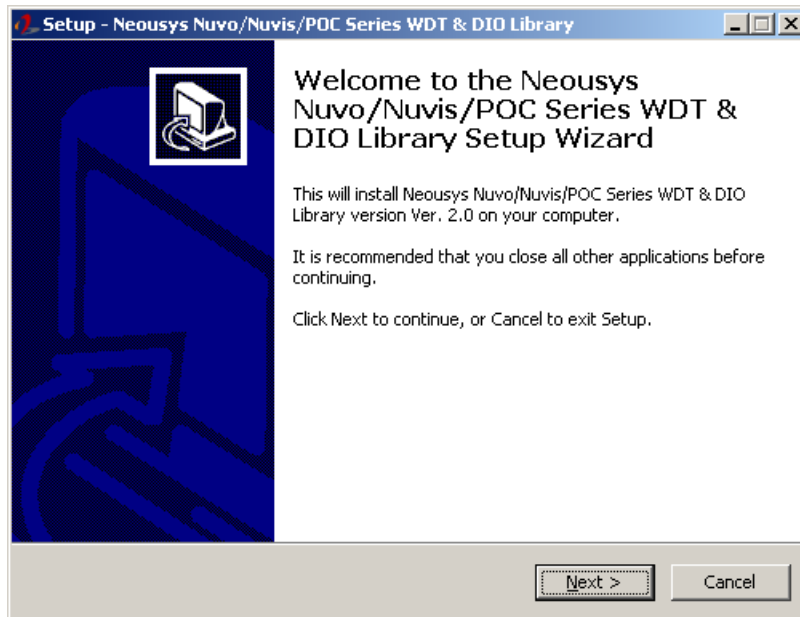

2. Click "Next >" and specify the directory of installing related files. The default directory is *C:\Neosys\WDT_DIO*.

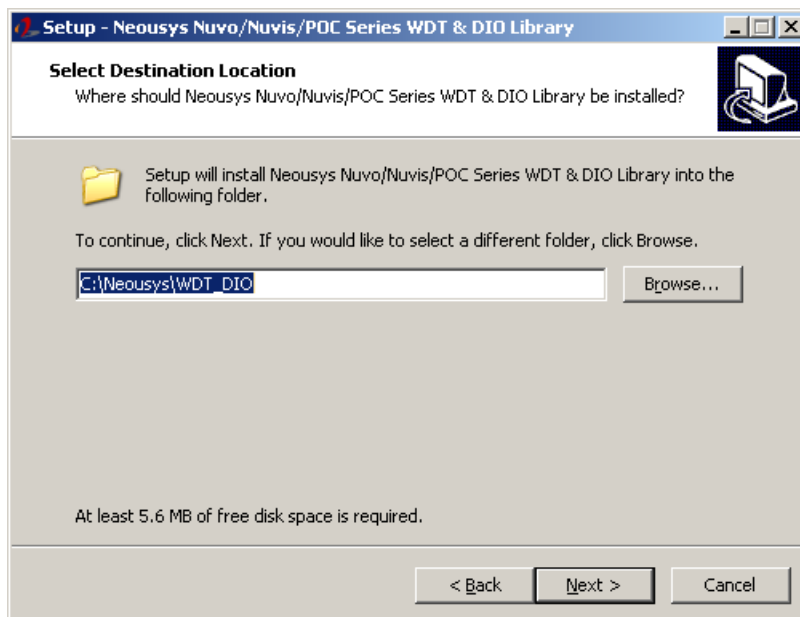

- Once the installation is finished, a dialog appears to prompt you to reboot the system. The WDT & DIO library will take effect after system rebooting.

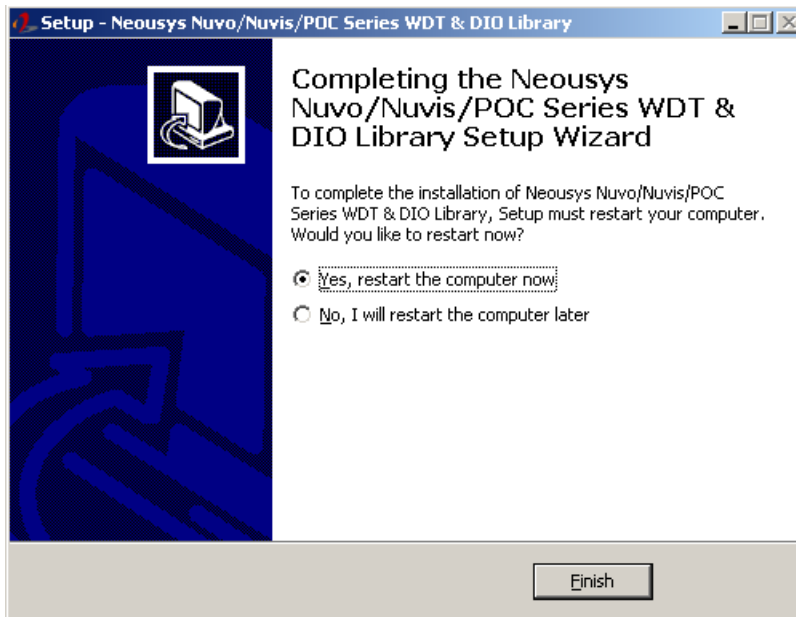

- When you programming your WDT or DIO program, the related files are located in
 - Header file: \Include
 - Lib file: \Lib
 - Function Reference: \Manual
 - Sample Code: \Sample\WDT_Demo (Demo for Watchdog Timer)
\Sample\PoE_Demo (Demo for Per-port PoE Control)

WDT Function Reference

InitWDT

Syntax

```
BOOL InitWDT(void);
```

Description

Initialize the WDT function. You should always invoke InitWDT() before set or start watchdog timer.

Parameter

None

Return Value

Returns TRUE if initialization successes, FALSE if initialization failed.

Usage

```
BOOL bRet = InitWDT();
```

SetWDT

Syntax

```
BOOL SetWDT(WORD tick, BYTE unit);
```

Description

Set timeout value and unit for watchdog timer. When InitWDT() is invoked, a default timeout value of 255 seconds is assigned.

Parameter

tick

WORD value (1 ~ 65535) to indicate timeout ticks.

unit

BYTE value (0 or 1) to indicate unit of timeout ticks.

0 : unit is minute

1: unit is second

Return Value

If value of unit is correct (0 or 1), this function returns TRUE, otherwise FALSE.

Usage

```
WORD tick=255;
```

```
BYTE unit=1; //unit is second.
```

```
BOOL bRet = SetWDT(tick, unit); //timeout value is 255 seconds
```



StartWDT

Syntax

```
BOOL StartWDT(void);
```

Description

Start countdown of WDT. When WDT is started, the WDT LED indicator starts to blink in a frequency of 1Hz. If no ResetWDT() or StopWDT is invoked before WDT is counted to 0, the WDT expires and system resets.

Parameter

None

Return Value

If the timeout value is given in correct format, this function returns TRUE, otherwise FALSE.

Usage

```
BOOL bRet = StartWDT();
```

ResetWDT

Syntax

```
BOOL ResetWDT(void);
```

Description

Reset the timeout value to the value given by SetWDT(). If no ResetWDT() or StopWDT is invoked before WDT is counted to 0, the WDT expires and system resets.

Parameter

None

Return Value

Always returns TRUE;

Usage

```
BOOL bRet = ResetWDT();
```

StopWDT

Syntax

```
BOOL StopWDT(void);
```

Description

Stop the countdown of WDT. When WDT is stopped, the WDT LED indicator stops blinking.

Parameter

None

Return Value



Always returns TRUE;

Usage

BOOL bRet = StopWDT()



Appendix C Using Per-Port PoE On/Off Control

Nuvo-5006E/5006P/5006LP offers four 802.3at PoE+ ports with a unique feature to allow users manually turn on or turn off the power of each PoE port. This can be helpfully for fault-recovery or device power reset purpose.

The function APIs are encapsulated in Neosys WDT_DIO driver package. Please following the instructions in **Appendix B - Install WDT_DIO Library** to install the driver package in prior to program per-port PoE on/off control function.

Per-Port PoE On/Off Control Function Reference

GetStatusPoEPort

Syntax

```
BYTE GetStatusPoEPort (Byte port);
```

Description

Get the current on/off status of designated PoE port.

Parameter

port

BYTE value specifies the index of PoE port. For Nuvo-5000 series, *port* should be a value of 1 ~ 4. You can refer to the following photo for the PoE port# of Nuvo-5000 series.



Return Value

BYTE value indicating PoE on/off status. 0 if port is disabled (off), 1 if port is enabled (on).

Usage

```
BYTE bEnabled = GetStatusPoEPort (1); //Get on/off status of PoE Port#1
```

EnablePoEPort

Syntax

BOOL EnablePoEPort (BYTE port);

Description

Turn on PoE power of designated PoE port.

Parameter

port

BYTE value specifies the index of PoE port. For Nuvo-5000 series, *port* should be a value of 1 ~ 4. You can refer to the following photo for the PoE port# of Nuvo-5000 series.



Return Value

Returns TRUE on success, return FALSE if the function failed.

Usage

BOOL bRet = EnablePoEPort (1); //Turn on PoE Port#1

DisablePoEPort

Syntax

BOOL DisablePoEPort (BYTE port);

Description

Turn off PoE power of designated PoE port.

Parameter

port

BYTE value specifies the index of PoE port. For Nuvo-5000 series, *port* should be a value of 1 ~ 4. You can refer to the following photo for the PoE port# of Nuvo-5000 series.



Return Value

Returns TRUE on success, return FALSE if the function failed.

Usage

```
BOOL bRet = DisablePoEPort (1); //Turn off PoE Port#1
```

