

Gladius G1056

10.4" AMD G-T56N Rugged Tablet PC



Features

- 10.4" AFFS+ TFT Active Matrix with Resistive and Digitizer Touch Screen
- AMD G-Series G-T56N Accelerated Processing Unit
- Integrated 4GB DDR3-1333 Memory and 32GB 1.8" SATA SSD Drive
- Multi Connectivity (WWAN, WLAN, Gigabit Ethernet, Bluetooth)
- Intergrated Dual 5.0 MP Auto Focus CMOS Cameras and RFID & NFC
- Hot-swappable redundant dual batteries
- AMD Radeon HD 6320 with DirectX® 11, OpenGLTM 4.1 and OpenCLTM 1.1 Support

System

CPU	AMD G-Series APU G-T56N dual-core 1.65GHz
Graphics Controller	AMD Radeon HD 6320
Memory	4GB DDR3 SO-DIMM memory module installed
Chipset	AMD Platform Control Hub A50M
BIOS	AMI Aptio® UEFI BIOS
Audio	1 x microphone 2 x 2W speakers 1 x Earphone jack
Storage	1 x 32GB 1.8" SATA SSD installed

Peripherals and Devices

Camera	1 x 5.0 MP front-facing AF CMOS camera (optional) 1 x 5.0 MP rear AF CMOS camera
RFID & NFC	1 x 13.56MHz, ISO 15693/14443A/ 14443B RFID & NFC Reader (distance: 3~5cm; speed: 5 cards/sec) (optional)
WLAN & Bluetooth	1 x WLAN 802.11 a/b/g/n & Bluetooth 2.1 + EDR
WWAN	HSUPA / HSPA+ / LTE for WWAN (optional)

I/O Interface

USB Port	4 x USB 2.0 ports
Serial Port	1 x RS-232 port (optional)
Ethernet	1 X RJ45 GbE LAN
Docking Port	1 x 35-pin pogo connector for docking connection
Video Port	1 x VGA; 1 x mini DisplayPort

Button & Indicator

Function Key	1 x 5-way function key
Power Button	1 x Power on/off button
LED	4 x LEDs (Power, Battery Status, WLAN/RFID, Bluetooth)

Touch Screen

Type	Analog Resistive
Controller Interface	USB Interface
Digitizer	Electromagnetic digitizer with battery-free pen

LCD Display

Size/Type	10.4" AFFS+ TFT Active Matrix Panel
Max. Resolution	1024 (H) x 768 (V)
Luminance	340 cd/m ²
Contrast Ratio	600:1
View Angle (U/D/R/L)	89°/89°/89°/89°
Backlight Type	LED

Power Supply

Adapter Input	100 ~ 240VAC (Full Range)
Adapter Output	19VDC, 4.74A, 90W
Battery Type	Li-battery pack
Battery Capacity	2 x 2500mAh 4-cell external battery pack
Battery Life	Up to 6 hours (depends on configuration and use)

Mechanical & Environmental

Operating Temp.	-20 ~ 45°C (-4 ~ 113°F)
Storage Temp.	-20 ~ 60°C (-4 ~ 140°F)
Discharging Temp.	-20 ~ 40°C (-4 ~ 104°F)
Charging Temp.	0 ~ 40°C (32 ~ 104°F)
Operating Humidity	10 ~ 95% @ 45°C (non-condensing)
Dimensions (W x H x D)	266.8 x 257.7 x 67.7 mm (10.5" x 10.1" x 2.7")
Gross Weight	1.8 kg (3.9 lb)
Vibration	3 Grms/ 5 ~ 500Hz/ random operation
Shock	40G peak acceleration (11 ms duration)
Transit Drop	3ft. (90cm), except the front side
IP Rating	IP54 (Front panel only)
Regulatory	CE/FCC Class B, VCCI certified

OS Support

Windows XP Embedded / Windows XP Professional
Windows Embedded 7 / Windows 7 Professional

Ordering Information

G1056	10.4" AMD G-Series T56N rugged tablet PC with WiFi, Bluetooth, Digitizer and Rear Camera
-------	--



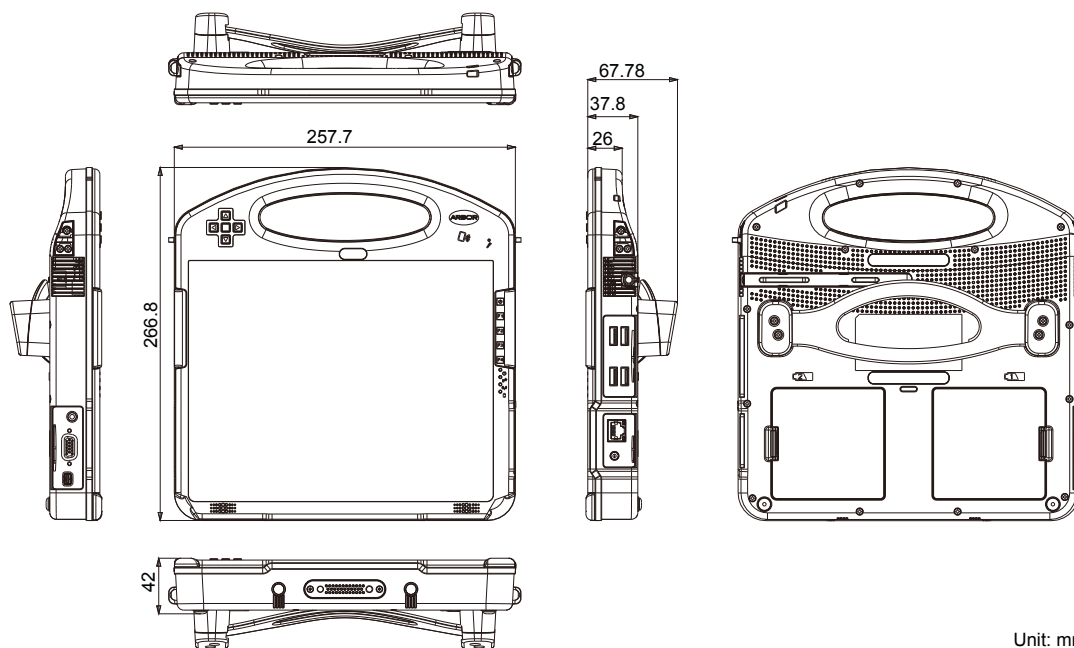

Dimensions









Unit: mm



Standard Accessories

PAC-G090W	19V/4.74A 90W AC/DC adapter kit	
Digitizer Pen	Digitizer pen kit	
eBATB-1056	2 x Black 2500mAh 4-cell external battery pack	

Optional Accessories

PAC-G090W	19V/4.74A 90W AC/DC adapter kit	
eBATB-1056	Black 2500mAh 4-cell external battery pack	
PEN-1056	Battery-free digitizer pen kit	
SST-1056	Shoulder strap, 128 x 3.7cm	
WMC-1056	Wall-mount cradle for G1056	
CHR-1056	Dual-bay battery charger for G1056	

Optional Configuration (CTOS* Kit) (Not Sold Separately)

CAM50F-1056	5.0M front CMOS camera kit	
RFID & NFC-1056	13.56MHz RFID & NFC kit	
HSUPA-1056	3.75G HSUPA wireless kit	

*CTOS means Configure-to-Order Service.