

Gladius G0820

8" Intel® Atom™ Z530P Rugged Tablet PC



Features

- 8" TFT Active Matrix Sunlight-readable Touch Panel
- Ultra Low Power Consumption
- Fully Rugged for Mobile POS/Warehousing/Vehicle Computer Application
- Meeting MIL-STD-810F, Whole Machine IP54 Grade, 6 ft. Drop Resistance
- High Mobility, Multi-network Connectivity (Bluetooth/WLAN/HSUPA 3.75G/GPS)
- Multi-identification Devices (Barcode, RFID)
- Hot-swappable Redundant Dual-batteries

System

CPU	Intel® Atom™ Z530P 1.6GHz processor
Graphics Controller	Intel® GMA 500
Memory	2GB DDR2 SO-DIMM memory module installed
Chipset	Intel® System Controller Hub US15WPT
BIOS	AMI BIOS
Audio	1 x Integrated microphone 1 x Integrated 1.5W speaker
Storage	1 x 32GB 1.8" SATA SSD

Peripherals and Devices

Camera	1 x 2.0 megapixels AF CMOS camera
RFID	Integrated ISO 15693/14443A/14443B RFID Reader (distance: 3~5cm; speed: 5 cards/sec) (optional)
Wi-Fi	Integrated WLAN 802.11 b/g/n
Bluetooth	Integrated Bluetooth 2.1 + EDR
GSM/UMTS	Optional HSUPA module (3.75G) for GSM/GPRS/EDGE, EV-DO networks
GPS	Integrated GPS receiver (optional)
Barcode Scanner	Integrated 1D/2D Barcode Scanner (optional)
SIM Socket	1 x SIM socket (located underneath the battery pack)
Hand Strap	1 x Black elastic hand strap

I/O Interface

Serial Port	1 x RS-232 port
USB Port	2 x USB 2.0 ports
Docking Port	1 x 35-pin pogo connector for docking connection

Button & Indicator

Function Key	6 x Function keys 2 x Menu buttons on the front 2 x Barcode Scanner trigger button on the sides
Power Button	1 x Power on/off button on the right side

LCD Display

Size/Type	8" active matrix TFT
Max. Resolution	1024 x 768 (XGA) w/ 16.2M colors
Luminance	700 cd/m ² (typ.)
Contrast Ratio	700 : 1
View Angle (U/D/R/L)	30°/30°/30°/30°
Backlight Type	LED

Touch Screen

Type	Analog Resistive Touch
Light Transparency	76% (typ.)
Controller Interface	USB Interface

Power Supply

Adapter Input	100 ~ 240VAC (Full Range)
Adapter Output	19VDC, 3.42A, 65W
Battery Type	Li-battery pack
Battery Capacity	2 x 2500mAh 3-cell
Battery Operating Time	8 hours (typ.)

Mechanical & Environmental

Discharging Temp.	-20 ~ 45°C (-4 ~ 113°F)
Charging Temp.	0 ~ 40°C (32 ~ 104°F)
Operating Humidity	10 ~ 95% @ 45°C (non-condensing)
Dimensions (W x D x H)	188 x 240 x 47 mm (7.4" x 9.45" x 1.85")
Gross Weight	1.8 kg (3.9 lb)
Vibration	3 Grms/ 5 ~ 500Hz/ random operation
Shock	75G peak acceleration (11 ms duration)
Transit Drop	6 ft. (182 cm) drop to concrete
IP Rating	IP54 (whole unit)
Regulatory	CE/FCC Class B Certified

OS Support

Windows 7 Embedded / Windows 7 Professional
Windows XP Embedded / Windows XP Professional



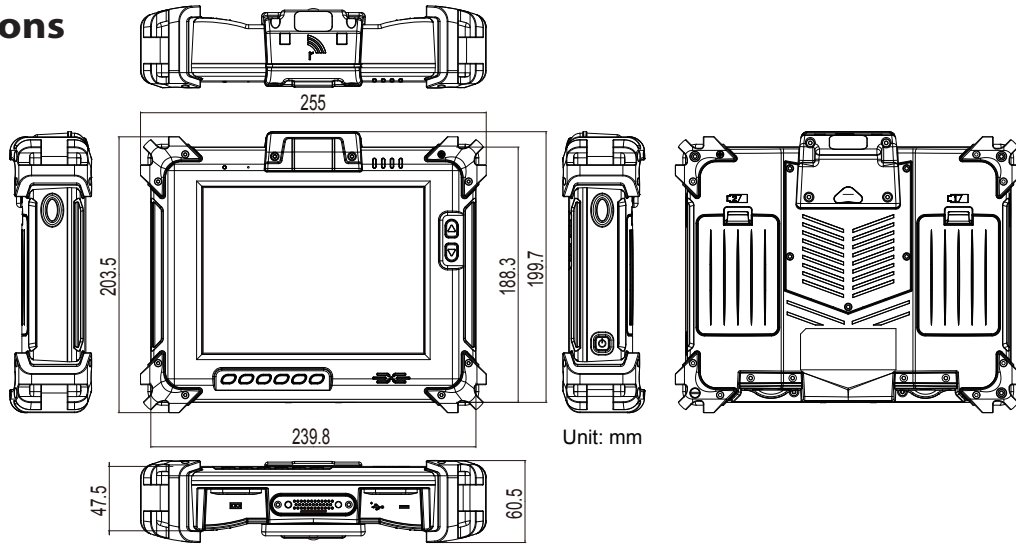

Ordering Information

G0820-Medium	8" Intel® Atom™ Z530P rugged tablet PC w/ camera, Bluetooth, WiFi
---------------------	---





Dimensions



Standard Accessories





Power Adapter	19V/3.4A 64.6W AC/DC Adapter Kit	
eBAT-0720	2 x 2500mAh External Battery Packs	
HST-0720-P	1 x G0720 Hand Strap w/ Pocket	
Stylus	For Touch Screen	

Optional Accessories

VMC-0720	Vehicle Mount Cradle	
CHR-0720	Dual-Bay External Battery Charger	
HST-0720	G0720 Hand Strap	
SST-0720	Shoulder Strap, 128 x 3.7cm	
eBAT-0720	2500mAh External Battery Pack	



Optional Configuration (CTOS* Kit)

RFID-0720	13.56MHz RFID Kit	
BarC-0720	1D/2D Barcode Scanner Kit	
HSUPA-0720	3.75G HSUPA Wireless Kit	
GPS-0820M	GPS Kit for G0820	

*CTOS means Configure-to-Order Service.
*GPS can only be installed when both Barcode and RFID are removed.