

FWS-7800

1U Rackmount

Network Appliance Platform

1 ATA-100, 2 SATA 3.0 Gb/s

6 USB Ports, 1 Mini-PCI Type 3

Copyright Notice

This document is copyrighted, 2011. All rights are reserved. The original manufacturer reserves the right to make improvements to the products described in this manual at any time without notice.

No part of this manual may be reproduced, copied, translated, or transmitted in any form or by any means without the prior written permission of the original manufacturer. Information provided in this manual is intended to be accurate and reliable. However, the original manufacturer assumes no responsibility for its use, or for any infringements upon the rights of third parties that may result from its use.

The material in this document is for product information only and is subject to change without notice. While reasonable efforts have been made in the preparation of this document to assure its accuracy, AAEON assumes no liabilities resulting from errors or omissions in this document, or from the use of the information contained herein.

AAEON reserves the right to make changes in the product design without notice to its users.

Acknowledgments

All other products' name or trademarks are properties of their respective owners.

- AMI is a trademark of American Megatrends Inc.
- CompactFlash™ is a trademark of the Compact Flash Association.
- Intel®, and Xeon Quad Core, are trademarks of Intel® Corporation.
- Microsoft Windows® is a registered trademark of Microsoft Corp.
- ISoundBlaster is a trademark of Creative Labs, Inc.

All other product names or trademarks are properties of their respective owners.

Packing List

Before you begin installing your card, please make sure that the following materials have been shipped:

- 1 FWS-7800
- 1 DVD-ROM for manual (in PDF format) and drivers
- 1 HDD Power Cable
- 2 Serial ATA Cable
- 1 D-Sub 9-pin Cable
- 1 CPU Heatsink 85mm x 85mm x 26mm
- 1 Ear Bracket Module, Black

If any of these items should be missing or damaged, please contact your distributor or sales representative immediately.

Contents

Chapter 1 General Information

1.1 Introduction.....	1-2
1.2 Features	1-3
1.3 Specifications	1-4
1.4 General System Information	1-7

Chapter 2 Quick Installation Guide

2.1 Safety Precautions	2-2
2.2 Location of Connectors	2-3
2.3 Mechanical Drawings of FWS-7800.....	2-5
2.4 List of Jumpers.....	2-6
2.5 List of Connectors	2-7
2.6 Setting Jumpers	2-8
2.7 Clear CMOS / RTC (JP1/JP2).....	2-9
2.8 AT/ATX Power Type Selection (JP3).....	2-9
2.9 Compact Flash Card Power Selection (JP4)	2-9
2.10 Front Panel Connector (FP1)	2-9
2.11 ATX POWER Connector (ATX1).....	2-9
2.12 AUX POWER 12 Connector (ATX 2)	2-10
2.13 VGA PIN HEADER (CN1)	2-10
2.14 PS2 Keyboard/Mouse Connector (CN2).....	2-11
2.15 USB 0/1/2/3 PIN HEADER (CN3/CN4).....	2-11
2.16 PCI-E Power Connector (CN7)	2-11

2.17 CPU/SYSTEM FAN Connector (CPU_FAN1/SYS_FAN_1~3).....	2-11
2.18 COM2 RS232 Serial Port PIN HEADER (COM1) ...	2-12
2.19 LCM & Key Pad Control Connector (LCMA)	2-12
2.20 Serial ATA power Connector (Power1~5).....	2-12
2.21 Installing the CPU and the Heatsink	2-13
2.22 Rackmount Slide Installation.....	2-19

Chapter 3 AMI BIOS Setup

3.1 System Test and Initialization	3-2
3.2 AMI BIOS Setup.....	3-3

Chapter 4 Driver Installation

4.1 Installation	4-3
------------------------	-----

Appendix A Programming the Watchdog Timer

A.1 Programming	A-2
A.2 ITE8718 Watchdog Timer Initial Program.....	A-6

Appendix B I/O Information

B.1 I/O Address Map	B-2
B.2 Memory Address Map.....	B-3
B.3 IRQ Mapping Chart.....	B-3
B.4 DMA Channel Assignments.....	B-3

Appendix C Standard Firewall Platform Setting

C.1 Standard Firewall Platform Setting.....	C-2
C.2 Status LED Sample Code.....	C-3

C.3 LAN Bypass Mode Sample Code C-6
C.4 LCM Sample Code C-8
C.5 Console Redirection C-14

Chapter

1

**General
Information**

1.1 Introduction

FWS-7800 adopts Intel® Xeon Quad Core™ 3400 series up to 3.06 GHz Processor. The chipset is equipped with Intel® 3450. In addition, the system memory features four 240-pin ECC DDR3 1066/1333 DIMM socket total up to 16GB and supports dual-channel. FWS-7800 deploys optional four Fiber Ethernet or eight Gigabit Ethernet (4 ports bypass function). The condensed appearance of FWS-7800 features 1U form factor that fits nicely into a space- limited environment.

This compact FWS-7800 is equipped with one Ultra ATA-100, two SATA3.0 Gb/s and CompactFlash™ Type II connector with ATA mode. In addition, it offers flexible expansion with network products and features one Mini-PCI Type 3 expansion slot, six USB2.0 ports and two RS-232 console ports. The console port deploys console re-direction that increases the network security via remote control. Moreover, there is a front panel support LCM with keypad control that allows for easy access and operation. All of these designs provide for a more user-friendly solution.

1.2 Features

- 1U Rackmount 10 LAN Ports Network Appliance
- Intel® Xeon Quad Core™ 3400 Series Up To 3.06 GHz
- 240-Pin Dual-Channel ECC DDR3 1066/1333 SDRAM DIMM x 4 (Up To 16 GB)
- Optional Fiber Ethernet x 4 or Gigabit Ethernet x 8 (4 Ports Bypass Function)
- Ultra ATA 100 Port x 1, SATA 3.0Gb/s x 2
- CompactFlash™ Type 2 x 1, Mini-PCI Type 3 x 1
- 300W Power With Auto Range Input
- USB2.0 x 6 (Pin Header x 4, Type A Port x 2 On Front Panel)
Parallel LCM With Keypad x 1, RS-232 Console x 1 On Front Panel
- Watchdog Function 1~255 Sec.
- 3.5" Internal Disk Drive Bay x 1, Dual 2.5" Internal Disk Drive Bay x 1 (Optional)

1.3 Specifications

System

Form Factor	1U 10-port Network Appliance
Processor	Intel® 45nm Quad Core™ Xeon 3400 series LGA1156
System Memory	240-pin Dual-Channel DCC DDR3 1066/1333 DIMM Socket x 4, up to 16 GB
Chipset	Intel® 3450
Ethernet (Optional)	10/100/1000Base-TX Ethernet w/ Intel® 82573L x 4 10 Gigabit Fiber LAN w/ Intel® 82599ES, SFP+ x 2 Gigabit Ethernet LAN w/ Intel® 82571ES, SFP x 2

Note: FWS-7800 supports “Boots on LAN” function for LAN1 only.

BIOS	AMI BIOS 32 Mb SPI ROM
Serial ATA	SATA 3.0 Gb/s x 2
SSD	CompactFlash™ Type 2 Connector (ATA Mode)
Expansion Interface	Mini-PCI Type 3 Socket
Watchdog Timer	1~255 steps, can be set with software on Super I/O

RTC	Internal RTC
Storage	Internal: 3.5" Hard Disk (SATA or IDE) x 1
System Fan	4 cm Ball Bearing Fan (Optional)
Front I/O Panel	Power LED x 1 Bypass LED x 1 Status LED x 1 HDD Active LED x 1 LAN LED x 10 (Optional) USB2.0 x 2 LAN x 10 (Optional) DB-9 x 1 LCM Display x 1 Reset Button x 1
Color	Black
LCM	16 x 2 characters with 4 keypad control
Power Supply	1U 300W w/ auto range input
Dimension	16.9" x 18.5" x 1.73" (430mm x 470mm x 44mm)
Power Consumption	95W, Intel [®] Xeon X3450 2.67 GHz

Display

VGA Controller	Pin header reserved for Graphic display
-----------------------	---

I/O

Serial Port	COM port x 2 (Internal Pin Header x 1) COM 1: RS-232 COM 2: RS-232 (Pin header)
Keyboard and Mouse	Reserved pin header
Universal Serial Bus	USB2.0 x 6: Dual Type A Connector on front panel x 2 Pin header x 4 (Internal)
Real I/O Panel	PCI-E[x1]/ PCI-X/ PCI Expansion slot x 1 (Optional)

Environmental

Operating Temperature	32°F~104°F (0°C~40°C)
Storage Temperature	-4°F~140°F (-20°C~60°C)
Operating Humidity	10~80%
Storage Humidity	10~80% @ 40°C, non-condensing
Vibration	0.5 g rms/ 5~500 Hz/ Operation (3.5" Hard Disk Drive) 1.5 g rms/ 5~500 Hz/ Non Operation
Shock	10 G peak acceleration (11 m sec. duration), operation 20 G peak acceleration (11 m sec. duration), non operation

1.4 General System Information

Front Panel

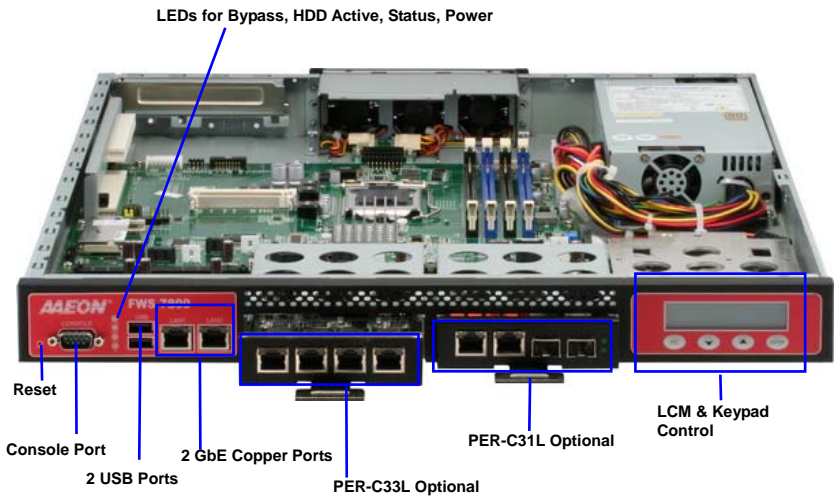

Rear Panel

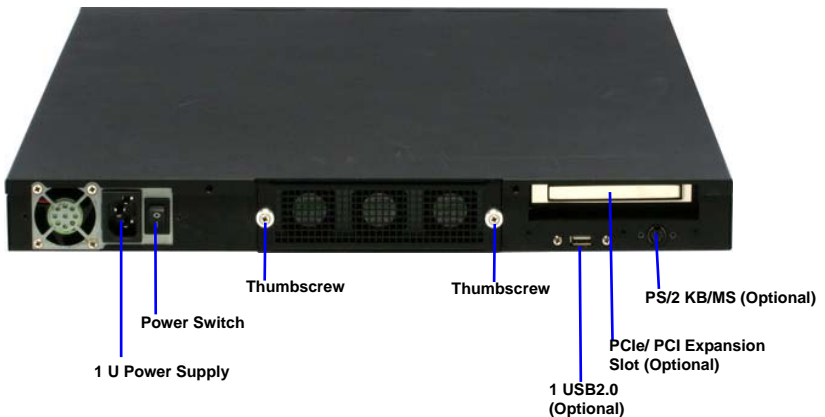

Note: These thumbscrews must be tightened with tools after initial and subsequent accessible installation.

Chapter

2

**FWS-7800
Quick
Installation
Guide**

2.1 Safety Precautions

The installation is intended for technically qualified personnel who have experience installing and configuring system boards.

The equipment can be installed in a restricted access location (RAL) only.

A restricted access location is a site location for equipment where the following criteria apply:

01. Access can only be gained by service persons or by users who have been trained on the restrictions and the precautions for this specific site.

02. Access is by means of at least one of the following, special tool, lock and key, or other means of security, and is controlled by the authority responsible for the location.

Safety Precautions:

Warning!



Always completely disconnect the power cord from your board whenever you are working on it. Do not make connections while the power is on, because a sudden rush of power can damage sensitive electronic components.

Caution!



Always ground yourself to remove any static charge before touching the board. Modern electronic devices are very sensitive to static electric charges. Use a grounding wrist strap at all times. Place all electronic components on a static-dissipative surface or in a static-shielded bag when they are not in the chassis

Risk of explosion if the battery is replaced by an incorrect type. Dispose of used batteries according to the instructions.

2.2 Location of Connectors

Board of FWS-7800

Component side

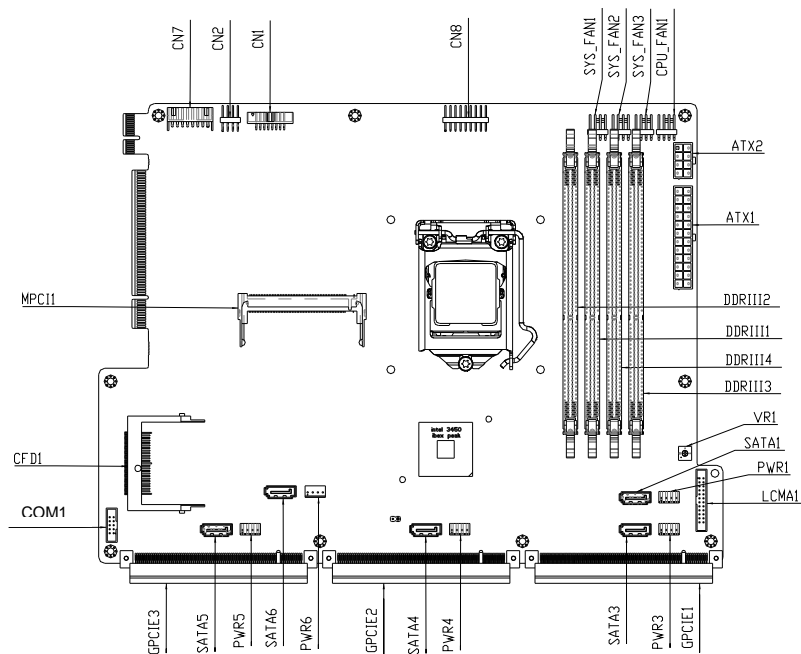

Solder Side

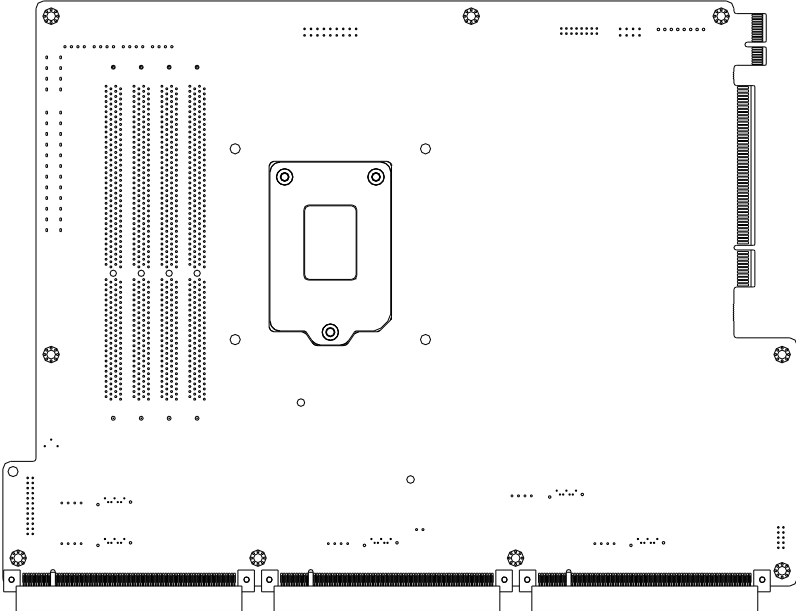

2.3 Mechanical Drawings of FWS-7800

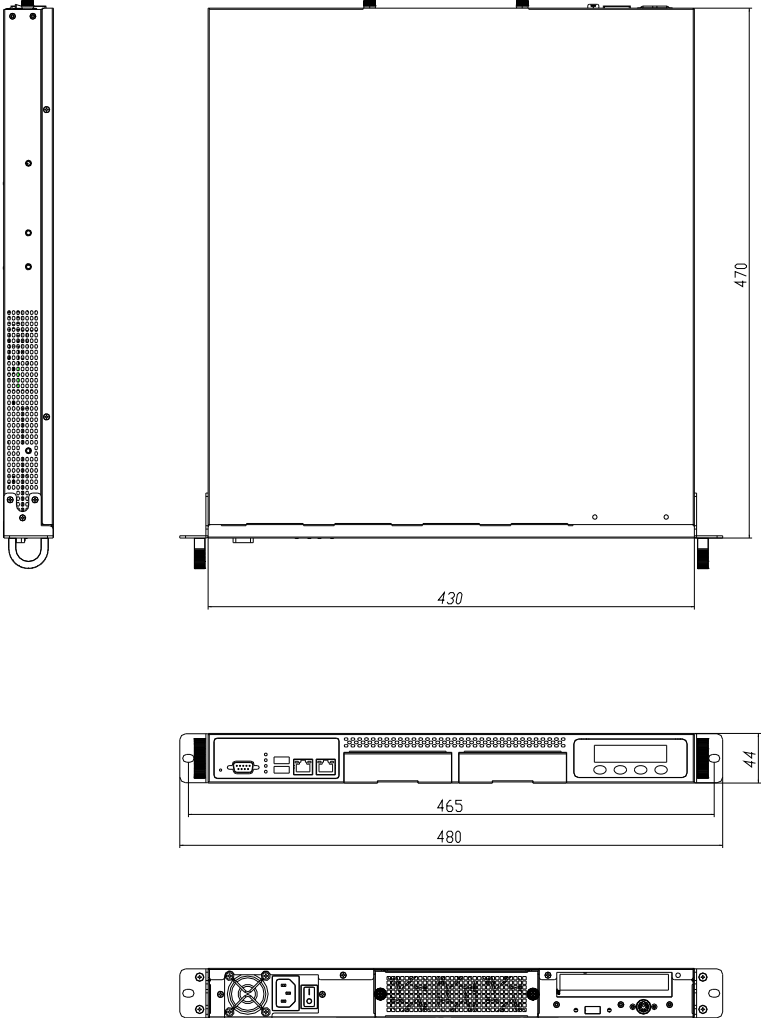

2.4 List of Jumpers

The board has a number of jumpers that allow you to configure your system to suit your application.

The table below shows the function of each of the board's jumpers:

Label	Function
JP1	Clear RTC
JP2	Clear CMOS
JP3	AT/ATX Power Type Select
JP4	Compact Flash Card Power Select
FP1	Front panel connector

2.5 List of Connectors

The board has a number of connectors that allow you to configure your system to suit your application. The table below shows the function of each board's connectors:

Label	Function
ATX1	ATX Power Connector
ATX2	AUX Power 12V Connector
CN1	VGA PIN HEADER
CN2	PS2 Keyboard / Mouse PIN HEADER
CN3	USB 0/1 PIN HEADER
CN4	USB 2/3 PIN HEADER
CN7	PCI-E Power Connector
CN8	External FAN PIN HEADER
CFD1	Compact Flash Socket
CPU_FAN1	CPU FAN Connector
COM1	COM2 PIN HEADER
DDRIII1~4	DIMM Slot
LCMA	LCM & Key Pad Control PIN HEADER
MPC11	Mini PCI Slot
Power1~5	Serial ATA power Connector
SYS_FAN1~3	System FAN1~3 Connector
SATA1~5	Serial ATA Connector

2.6 Setting Jumpers

You configure your card to match the needs of your application by setting jumpers. A jumper is the simplest kind of electric switch. It consists of two metal pins and a small metal clip (often protected by a plastic cover) that slides over the pins to connect them. To “close” a jumper you connect the pins with the clip.

To “open” a jumper you remove the clip. Sometimes a jumper will have three pins, labeled 1, 2 and 3. In this case you would connect either pins 1 and 2 or 2 and 3.

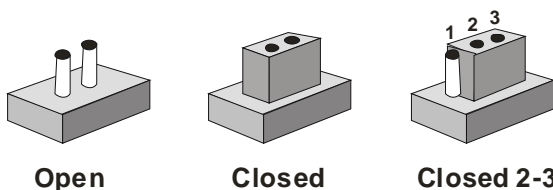

A pair of needle-nose pliers may be helpful when working with jumpers.

If you have any doubts about the best hardware configuration for your application, contact your local distributor or sales representative before you make any change.

Generally, you simply need a standard cable to make most connections.

2.7 Clear CMOS / RTC (JP1/JP2)

JP1, JP2	Function
1-2	Protected (Default)
2-3	Clear

2.8 AT/ATX Power Type Selection (JP3)

JP3	Function
Close 1-2	AT (Default)
Close 2-3	ATX

2.9 Compact Flash Card Power Selection (JP4)

JP4	Function
Close 1-2	+5V
Close 2-3	+3.3V (Default)

2.10 Front Panel Connector (FP1)

Pin	Signal	Pin	Signal
1	PWRBTN-	2	PWRBTN+
3	IDELED-	4	IDELED+
5	SPEAKER-	6	SPEAKER+
7	POWERLED-	8	POWERLED+
9	RESET-	10	RESET+

2.11 ATX POWER Connector (ATX1)

Pin	Signal	Pin	Signal
1	+3.3V	2	+3.3V
3	GND	4	+5V
5	GND	6	+5V

7	GND	8	PWROK
9	+5VSB	10	+12V
11	+12V	12	+3.3V
13	+3.3V	14	-12V
15	GND	16	PS_ON
17	GND	18	GND
19	GND	20	NC
21	+5V	22	+5V
23	+5V	24	GND

2.12 AUX POWER 12 Connector (ATX 2)

Pin	Signal	Pin	Signal
1	GND	2	GND
3	GND	4	GND
5	+12V	6	+12V
7	+12V	8	+12V

2.13 VGA PIN HEADER (CN1)

Pin	Signal	Pin	Signal
1	Red	2	+5V
3	Green	4	GND
5	Blue	6	CRT Plug#
7	NC	8	DDC_DATA
9	GND	10	H sync
11	GND	12	V sync
13	GND	14	DDC_CLK
15	GND	16	NC

2.14 PS2 Keyboard/Mouse Connector (CN2)

Pin	Signal	Pin	Signal
1	KB_DATA	2	KB_CLK
3	GND	4	+5V
5	MS_DATA	6	MS_CLK
7	NC	8	NC

2.15 USB 0/1/2/3 PIN HEADER (CN3/CN4)

Pin	Signal	Pin	Signal
1	+5V	2	GND
3	USBD-	4	GND
5	USBD+	6	USBD+
7	GND	8	USBD-
9	GND	10	+5V

2.16 PCI-E Power Connector (CN7)

Pin	Signal	Pin	Signal
1	GND	2	+3.3V
3	+3.3V	4	+3.3V
5	-12V	6	+5V
7	+5V	8	GND

2.17 CPU/SYSTEM FAN Connector (CPU_FAN1/SYS_FAN_1~3)

Pin	Signal	Pin	Signal
1	GND	2	+12V
3	FAN Sense	4	FAN Control

2.18 COM2 RS232 Serial Port PIN HEADER (COM1)

Pin	Signal	Pin	Signal
1	DCD	2	RXD
3	TXD	4	DTR
5	GND	6	DSR
7	RTS	8	CTS
9	RI	10	NC

2.19 LCM & Key Pad Control Connector (LCMA)

Pin	Signal	Pin	Signal
1	POWER	2	GND
3	LSLIN-	4	VEE
5	LAFD-	6	LINIT-
7	LPD1	8	LPD0
9	LPD3	10	LPD2
11	LPD5	12	LPD4
13	LPD7	14	LPD6
15	LCD-	16	VCC
17	UP	18	RIGHT
19	LEFT	20	DOWN
21	RESET	22	NC
23	NC	24	NC

2.20 Serial ATA power Connector (Power1~5)

Pin	Signal	Pin	Signal
1	+12V	2	GND
3	GND	4	+5V

2.21 Installing the CPU and the Heatsink

Step 1: Release the lock pole of the CPU bracket

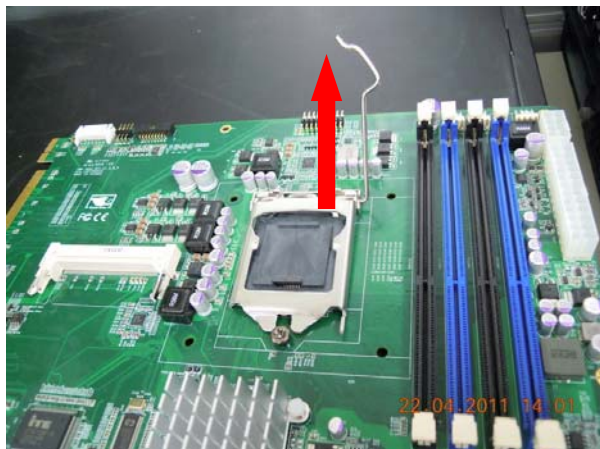
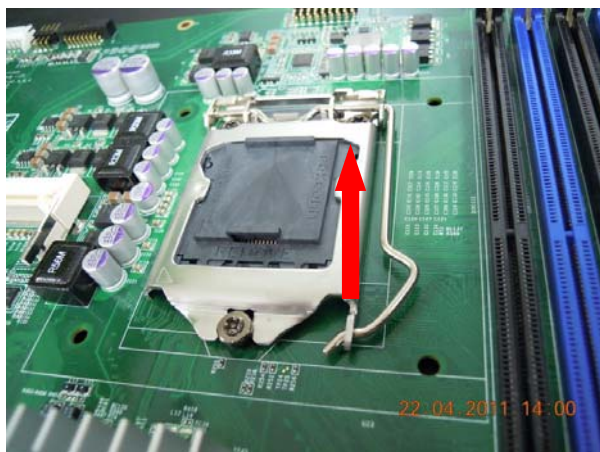

Step 2: Lift up the CPU bracket

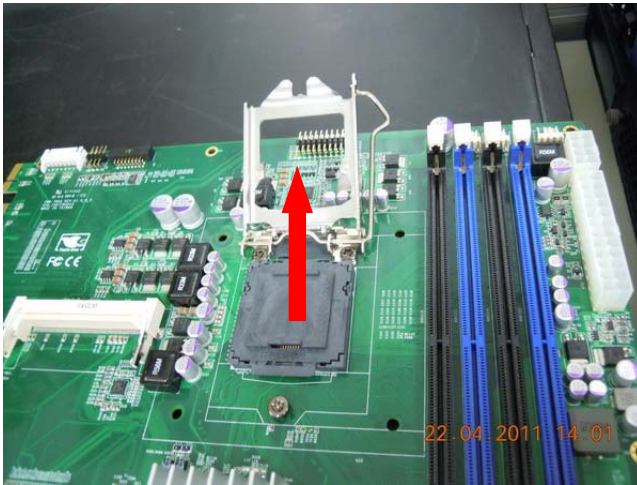

Step 3: Lift up the CPU cover

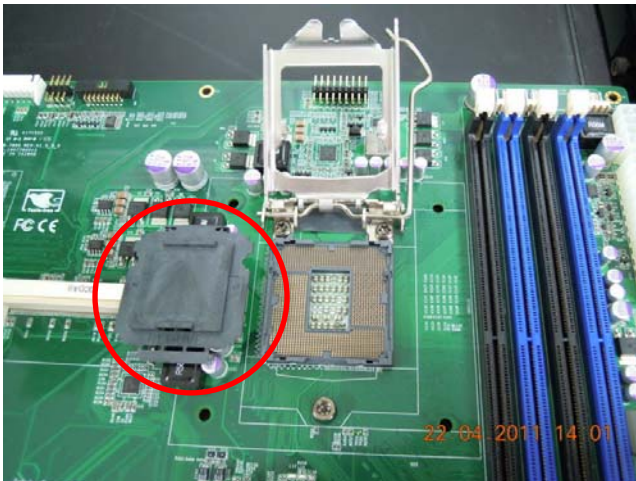

UStep 4U: Place the CPU to the socket and have the two fillisters locked properly

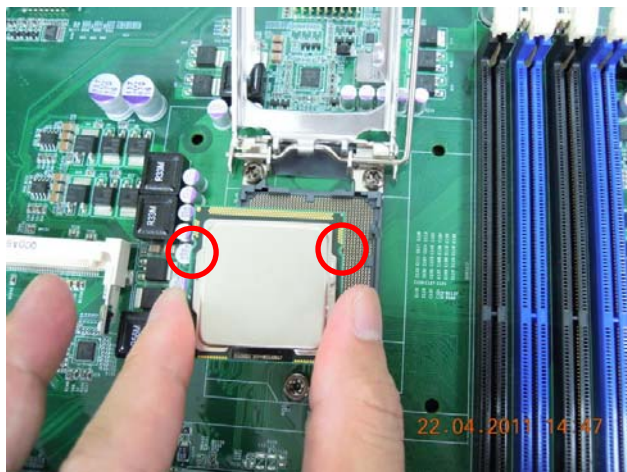

Step 5: Close the CPU bracket and lock the pole to the position

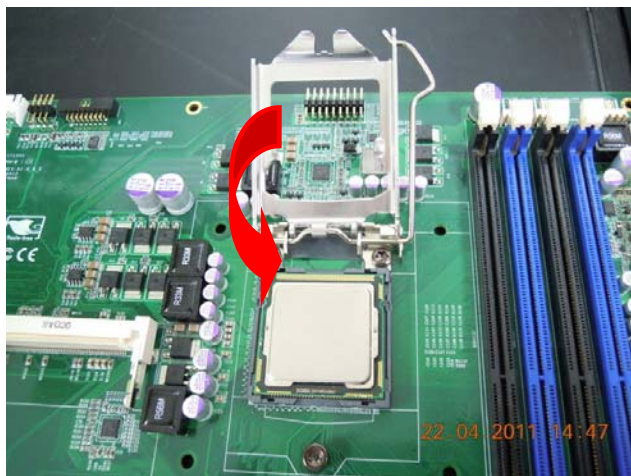

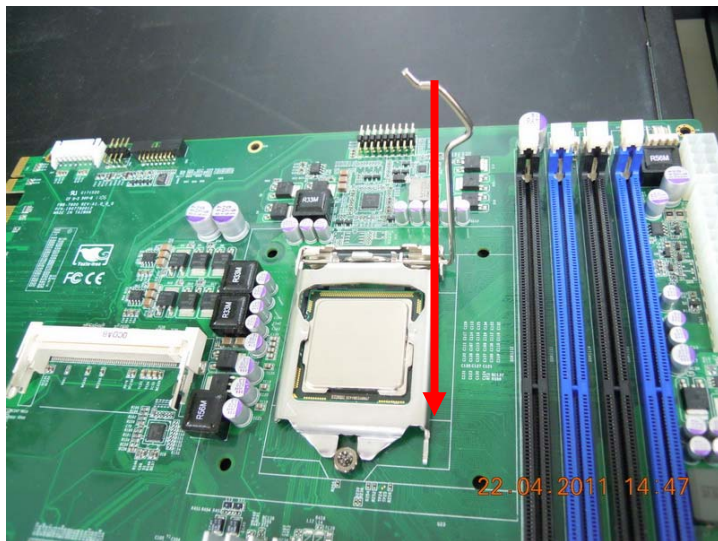

UStep 6U: Cover the Heatsink on the CPU and watch out the direction of the Heatsink that did not against the airflow



Step 7: Fasten the four screws to lock the air duct

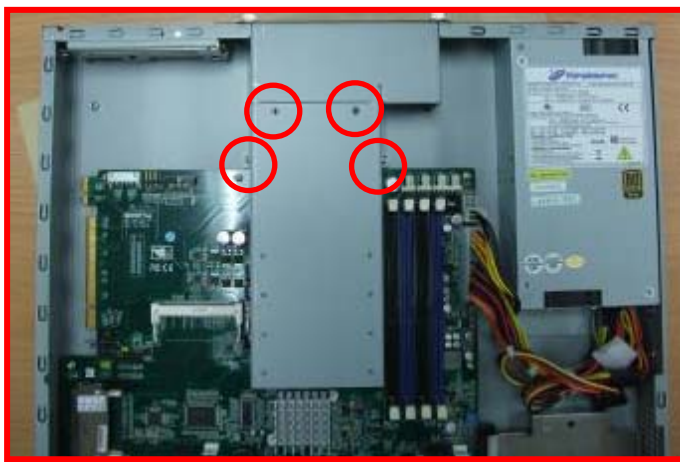

Step 8: Lock the cables in position and done the CPU installation



2.22 Rackmount Slide Installation

Columbus 1U rack mount slide installation instruction

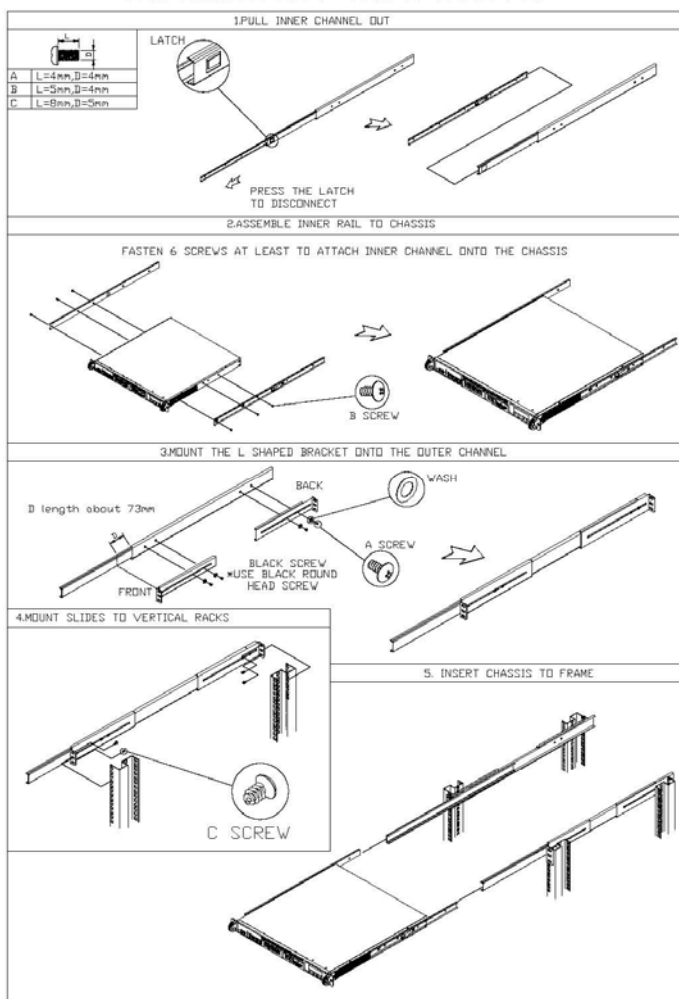

Din-Rail Rack Mounting



Installation environment caution:

1. Elevated Operating Ambient - If installed in a closed or multi-unit rack assembly, the operating ambient temperature of the rack environment may be greater than room ambient. Therefore, consideration should be given to installing the equipment in an environment compatible with the maximum ambient temperature (T_{ma}) specified by the manufacturer.
2. Reduced Air Flow - Installation of the equipment in a rack should be such that the amount of air flow required for safe operation of the equipment is not compromised. Mechanical Loading - Mounting of the equipment in the rack should be such that a hazardous condition is not created due to uneven mechanical loading.
3. Circuit Overloading - Consideration should be given to the connection of the equipment to the supply circuit and the effect that overloading of the circuits might have on over-current protection and supply wiring. Appropriate consideration of equipment nameplate ratings should be used when addressing this concern.
4. Reliable Earthing - Reliable earthing of rack-mounted equipment should be maintained. Particular attention should be given to supply connections other than direct connections to the branch circuit (e.g. use of power strips)."



CAUTION :

Slide/rail mounted equipment is not to be used as a shelf or a work space.

Below Table for China RoHS Requirements

产品中有毒有害物质或元素名称及含量

AAEON Boxer/ Industrial System

部件名称	有毒有害物质或元素					
	铅 (Pb)	汞 (Hg)	镉 (Cd)	六价铬 (Cr(VI))	多溴联苯 (PBB)	多溴二苯醚 (PBDE)
印刷电路板 及其电子组件	×	○	○	○	○	○
外部信号 连接器及线材	×	○	○	○	○	○
外壳	×	○	○	○	○	○
中央处理器 与内存	×	○	○	○	○	○
硬盘	×	○	○	○	○	○
电源	×	○	○	○	○	○
<p>O: 表示该有毒有害物质在该部件所有均质材料中的含量均在 SJ/T 11363-2006 标准规定的限量要求以下。</p> <p>X: 表示该有毒有害物质至少在该部件的某一均质材料中的含量超出 SJ/T 11363-2006 标准规定的限量要求。</p> <p>备注： 一、此产品所标示之环保使用期限，系指在一般正常使用状况下。 二、上述部件物质中央处理器、内存、硬盘、电源为选购品。</p>						

Chapter

3

**AMI
BIOS Setup**

3.1 System Test and Initialization

These routines test and initialize board hardware. If the routines encounter an error during the tests, you will either hear a few short beeps or see an error message on the screen. There are two kinds of errors: fatal and non-fatal. The system can usually continue the boot up sequence with non-fatal errors.

System configuration verification

These routines check the current system configuration against the values stored in the CMOS memory. If they do not match, the program outputs an error message. You will then need to run the BIOS setup program to set the configuration information in memory.

There are three situations in which you will need to change the CMOS settings:

1. You are starting your system for the first time
2. You have changed the hardware attached to your system
3. The CMOS memory has lost power and the configuration information has been erased.

The FWS-7800 CMOS memory has an integral lithium battery backup for data retention. However, you will need to replace the complete unit when it finally runs down.

3.2 AMI BIOS Setup

AMI BIOS ROM has a built-in Setup program that allows users to modify the basic system configuration. This type of information is stored in battery-backed CMOS RAM so that it retains the Setup information when the power is turned off.

Entering Setup

Power on the computer and press or <F2> immediately. This will allow you to enter Setup.

Main

Set the date, use tab to switch between date elements.

Advanced

Enable/disable boot option for legacy network devices.

Chipset

host bridge parameters.

Boot

Enables/disables quiet boot option.

Security

Set setup administrator password.

Save&Exit

Exit system setup after saving the changes.

Chapter

4

**Driver
Installation**

The FWS-7800 comes with an AutoRun DVD-ROM that contains all drivers and utilities that can help you to install the driver automatically.

Insert the driver DVD, the driver DVD-title will auto start and show the installation guide. If not, please follow the sequence below to install the drivers.

Follow the sequence below to install the drivers:

Step 1 – Install Chipset Driver

Step 2 – Install VGA Driver

Step 3 – Install LAN Driver

Please read instructions below for further detailed installations.

4.1 Installation

Insert the FWS-7800 CD-ROM into the CD-ROM drive and install the drivers from Step 1 to Step 3 in order.

Step 1 – Install Chipset Driver

1. Click on the **STEP1-CHIPSET** folder and select the OS folder your system is
2. Double click on the **.exe** file located in each OS folder
3. Follow the instructions that the window shows
4. The system will help you install the driver automatically

Step 2 – Install VGA Driver

1. Click on the **STEP2-VGA** folder and select the OS folder your system is
2. Double click on the **.exe** file located in each OS folder
3. Follow the instructions that the window shows
4. The system will help you install the driver automatically

Step 3 – Install LAN Driver

1. Click on the **STEP3-LAN** folder and select the OS folder your system is
2. Double click on the **.exe** file located in each OS folder
3. Follow the instructions that the window shows
4. The system will help you install the driver automatically

Appendix

A

Programming the Watchdog Timer

A.1 Programming

FWS-7800 utilizes ITE 8718 chipset as its watchdog timer controller. (K version)

Below are the procedures to complete its configuration and the AAeon initial watchdog timer program is also attached based on which you can develop customized program to fit your application.

Configuring Sequence Description

After the hardware reset or power-on reset, the ITE 8718 enters the normal mode with all logical devices disabled except KBC.

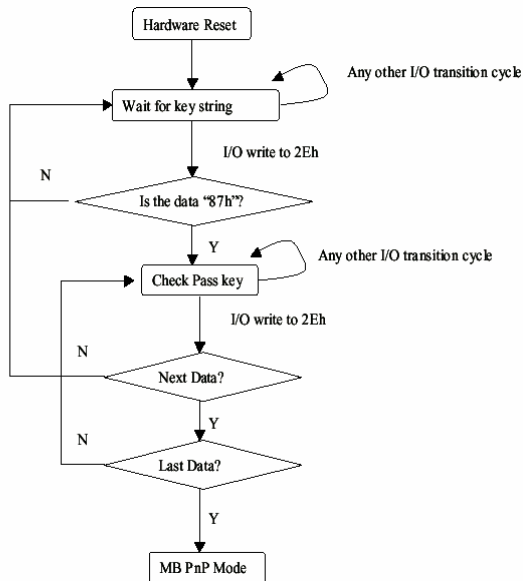

There are three steps to complete the configuration setup: (1) Enter the MB PnP Mode; (2) Modify the data of configuration registers; (3) Exit the MB PnP Mode. Undesired result may occur if the MB PnP Mode is not exited normally.

(1) Enter the MB PnP Mode

To enter the MB PnP Mode, four special I/O write operations are to be performed during Wait for Key state. To ensure the initial state of the key-check logic, it is necessary to perform four write operations to the Special Address port (2EH). Two different enter keys are provided to select configuration ports (2Eh/2Fh) of the next step.

	Address Port	Data Port
87h, 01h, 55h, 55h:	2Eh	2Fh

(2) Modify the Data of the Registers

All configuration registers can be accessed after entering the MB PnP Mode. Before accessing a selected register, the content of Index 07h must be changed to the LDN to which the register belongs, except some Global registers.

(3) Exit the MB PnP Mode

Set bit 1 of the configure control register (Index=02h) to 1 to exit the MB PnP Mode.

WatchDog Timer Configuration Registers

LDN	Index	R/W	Reset	Configuration Register or Action
All	02H	W	N/A	Configuration Control
07H	71H	R/W	00H	WatchDog Timer Control Register
07H	72H	R/W	00H	WatchDog Timer Configuration Register
07H	73H	R/W	00H	WatchDog Timer Time-out Value (LSB) Register
07H	74H	R/W	00H	WatchDog Timer Time-out Value (MSB) Register

Configure Control (Index=02h)

This register is write only. Its values are not sticky; that is to say, a hardware reset will automatically clear the bits, and does not require the software to clear them.

Bit	Description
7-2	Reserved
1	Returns to the Wait for Key state. This bit is used when the configuration sequence is completed.
0	Resets all logical devices and restores configuration registers to their power-on states.

WatchDog Timer Control Register (Index=71h, Default=00h)

Bit	Description
7	WDT is reset upon a CIR interrupt
6	WDT is reset upon a KBC (Mouse) interrupt
5	WDT is reset upon a KBC (Keyboard) interrupt
4	Reserved
3-2	Reserved
1	Force Time-out. This bit is self-clearing
0	WDT status 1: WDT value reaches 0 0: WDT value is not 0

WatchDog Timer Configuration Register (Index=72h, Default=00h)

Bit	Description
7	WDT Time-out value select 1: Second 0: Minute
6	WDT output through KRST (pulse) enable
5	WDT Time-out value Extra select 1: 4s. 0: Determine by WDT Time-out value select (bit7 of this register)
4	WDT output through PWROK1/PWROK2 (pulse) enable
3	Select the interrupt level ^{note} for WDT

**WatchDog Timer Time-out Value (LSB) Register (Index=73h,
Default=00h)**

Bit	Description
------------	--------------------

7-0	WDT Time-out value 7-0
-----	------------------------

**WatchDog Timer Time-out Value (MSB) Register (Index=74h,
Default=00h)**

Bit	Description
------------	--------------------

7-0	WDT Time-out value 15-8
-----	-------------------------

A.2 ITE8718 Watchdog Timer Initial Program

```
.MODEL SMALL
```

```
.CODE
```

Main:

```
CALL Enter_Configuration_mode
```

```
CALL Check_Chip
```

```
mov cl, 7
```

```
call Set_Logic_Device
```

```
;time setting
```

```
mov cl, 10 ; 10 Sec
```

```
dec al
```

Watch_Dog_Setting:

```
;Timer setting
```

```
mov al, cl
```

```
mov cl, 73h
```

```
call Superio_Set_Reg
```

```
;Clear by keyboard or mouse interrupt
```

```
mov al, 0f0h
```

```
mov cl, 71h
```

```
call Superio_Set_Reg
```

```
;unit is second.
```

```
mov al, 0C0H
```

```
mov cl, 72h
```

```
call Superio_Set_Reg
```

```
; game port enable  
mov cl, 9  
call Set_Logic_Device
```

```
Initial_OK:  
CALL Exit_Configuration_mode  
MOV AH,4Ch  
INT 21h
```

```
Enter_Configuration_Mode PROC NEAR  
MOV SI,WORD PTR CS:[Offset Cfg_Port]
```

```
MOV DX,02Eh  
MOV CX,04h  
Init_1:  
MOV AL,BYTE PTR CS:[SI]  
OUT DX,AL  
INC SI  
LOOP Init_1  
RET  
Enter_Configuration_Mode ENDP
```

```
Exit_Configuration_Mode PROC NEAR  
MOV AX,0202h  
CALL Write_Configuration_Data
```

RET

Exit_Configuration_Mode ENDP

Check_Chip PROC NEAR

MOV AL,20h

CALL Read_Configuration_Data

CMP AL,87h

JNE Not_Initial

MOV AL,21h

CALL Read_Configuration_Data

CMP AL,12h

JNE Not_Initial

Need_Initial:

STC

RET

Not_Initial:

CLC

RET

Check_Chip ENDP

Read_Configuration_Data PROC NEAR

MOV DX,WORD PTR CS:[Cfg_Port+04h]

OUT DX,AL

```
MOV DX,WORD PTR CS:[Cfg_Port+06h]
IN AL,DX
RET
Read_Configuration_Data ENDP
```

```
Write_Configuration_Data PROC NEAR
MOV DX,WORD PTR CS:[Cfg_Port+04h]
OUT DX,AL
XCHG AL,AH
MOV DX,WORD PTR CS:[Cfg_Port+06h]
OUT DX,AL
RET
Write_Configuration_Data ENDP
```

```
Superio_Set_Reg proc near
push ax
MOV DX,WORD PTR CS:[Cfg_Port+04h]
mov al,cl
out dx,al
pop ax
inc dx
out dx,al
ret
Superio_Set_Reg endp.Set_Logic_Device proc near
```

```
Set_Logic_Device proc near
push ax
push cx
xchg al,cl
mov cl,07h
call Superio_Set_Reg
pop cx
pop ax
ret
Set_Logic_Device endp
```

```
;Select 02Eh->Index Port, 02Fh->Data Port
Cfg_Port DB 087h,001h,055h,055h
```

```
DW 02Eh,02Fh
```

END Main

Note: Interrupt level mapping

0Fh-Dh: not valid

0Ch: IRQ12

.

.

03h: IRQ3

02h: not valid

01h: IRQ1

00h: no interrupt selected

Appendix

B

I/O Information

B.1 I/O Address Map

Input/output (IO)	
[00000000 - 0000000F]	Direct memory access controller
[00000000 - 00000CF7]	PCI bus
[00000010 - 0000001F]	Motherboard resources
[00000020 - 00000021]	Programmable interrupt controller
[00000022 - 0000003F]	Motherboard resources
[00000040 - 00000043]	System timer
[00000044 - 0000005F]	Motherboard resources
[00000060 - 00000060]	Standard 101/102-Key or Microsoft Natural PS/2 Keyboard
[00000061 - 00000061]	System speaker
[00000062 - 00000063]	Motherboard resources
[00000064 - 00000064]	Standard 101/102-Key or Microsoft Natural PS/2 Keyboard
[00000065 - 0000006F]	Motherboard resources
[00000070 - 00000071]	System CMOS/real time clock
[00000072 - 0000007F]	Motherboard resources
[00000080 - 00000080]	Motherboard resources
[00000081 - 00000083]	Direct memory access controller
[00000084 - 00000086]	Motherboard resources
[00000087 - 00000087]	Direct memory access controller
[00000088 - 00000088]	Motherboard resources
[00000089 - 0000008B]	Direct memory access controller
[0000008C - 0000008E]	Motherboard resources
[0000008F - 0000008F]	Direct memory access controller
[00000090 - 0000009F]	Motherboard resources
[000000A0 - 000000A1]	Programmable interrupt controller
[000000A2 - 000000BF]	Motherboard resources
[000000C0 - 000000DF]	Direct memory access controller
[000000E0 - 000000EF]	Motherboard resources
[000000F0 - 000000FF]	Numeric data processor
[00000170 - 00000177]	Secondary IDE Channel
[000001F0 - 000001F7]	Primary IDE Channel
[00000274 - 00000277]	ISAPNP Read Data Port
[00000279 - 00000279]	ISAPNP Read Data Port
[000002F8 - 000002FF]	Communications Port (COM2)
[00000376 - 00000376]	Secondary IDE Channel
[00000378 - 0000037F]	Printer Port (LPT1)
[000003B0 - 000003B8]	Intel(R) HD Graphics
[000003C0 - 000003DF]	Intel(R) HD Graphics
[000003F6 - 000003F6]	Primary IDE Channel
[000003F8 - 000003FF]	Communications Port (COM1)
[00000400 - 0000047F]	System board
[000004D0 - 000004D1]	Motherboard resources
[00000500 - 0000057F]	System board
[00000778 - 0000077F]	Motherboard resources
[00000A00 - 00000A1F]	Motherboard resources
[00000A79 - 00000A79]	ISAPNP Read Data Port
[00000D00 - 0000FFFF]	PCI bus
[00001180 - 0000119F]	System board
[0000D000 - 0000D01F]	Intel(R) PRO/1000 PL Network Connection
[0000D000 - 0000DFFF]	Intel(R) 5 Series/3400 Series Chipset Family PCI Express Root Port 7 - 3B4E
[0000E000 - 0000E01F]	Intel(R) PRO/1000 PL Network Connection #2
[0000E000 - 0000EFFF]	Intel(R) 5 Series/3400 Series Chipset Family PCI Express Root Port 6 - 3B4C
[0000F000 - 0000F01F]	Intel(R) 5 Series/3400 Series Chipset Family SMBus Controller - 3B30
[0000F020 - 0000F02F]	Intel(R) 5 Series/3400 Series Chipset Family 2 port Serial ATA Storage Controller - 3B26
[0000F030 - 0000F03F]	Intel(R) 5 Series/3400 Series Chipset Family 2 port Serial ATA Storage Controller - 3B26
[0000F040 - 0000F043]	Intel(R) 5 Series/3400 Series Chipset Family 2 port Serial ATA Storage Controller - 3B26
[0000F050 - 0000F057]	Intel(R) 5 Series/3400 Series Chipset Family 2 port Serial ATA Storage Controller - 3B26
[0000F060 - 0000F063]	Intel(R) 5 Series/3400 Series Chipset Family 2 port Serial ATA Storage Controller - 3B26
[0000F070 - 0000F077]	Intel(R) 5 Series/3400 Series Chipset Family 2 port Serial ATA Storage Controller - 3B26
[0000F080 - 0000F08F]	Intel(R) 5 Series/3400 Series Chipset Family 4 port Serial ATA Storage Controller - 3B20
[0000F090 - 0000F09F]	Intel(R) 5 Series/3400 Series Chipset Family 4 port Serial ATA Storage Controller - 3B20
[0000F0E0 - 0000F0E7]	Intel(R) HD Graphics

B.2 Memory Address Map



B.3 IRQ Mapping Chart

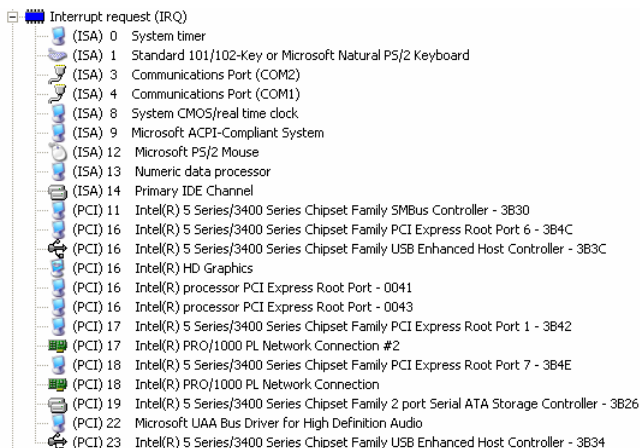

B.4 DMA Channel Assignments

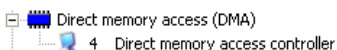

Appendix

C

Standard Firewall Platform Setting

C.1 Standard Firewall Platform Setting

Status LED	Disable	I/O PORT 48Fh set bit 4 to 1, I/O PORT 4B8h set bit 3 to 1
	Red LED ON	I/O PORT 48Fh set bit 4 to 1, I/O PORT 4B8h set bit 3 to 0
	Red LED Blink	I/O PORT 48Fh set bit 4 to 1, I/O PORT 4B8h set bit 3 to 0 I/O PORT 49Bh set bit 4 to 1
	Green LED ON	I/O PORT 48Fh set bit 4 to 0, I/O PORT 4B8h set bit 3 to 1
	Green LED Blink	I/O PORT 48Fh set bit 4 to 0, I/O PORT 4B8h set bit 3 to 1 I/O PORT 49Bh set bit 4 to 1
LAN Bypass	Disable	I/O PORT 48Dh set bit 7 to 1, I/O PORT 48Fh set bit 2 to 0
	Force Mode	I/O PORT 48Dh set bit 7 to 0, I/O PORT 48Fh set bit 2 to 0
	Watch Dog Mode	I/O PORT 48Dh set bit 7 to 1, I/O PORT 48Fh set bit 2 to 1
LCM Function	Disable	
	378/IRQ7	
Software Reset		Press Software Reset button I/O PORT: 4B8h bit 6 will be set 1

C.2 Status LED Sample Code

Status LED Sample code

[Disabled LED Function]

```
mov dx,48Fh          ;( IO_PORT = 48Fh)
in  al,dx
or  al,00010000b ;set bit 4 -->high
out dx,al
```

```
mov dx,4B8h          ;( IO_PORT = 4B8h)
in  al,dx
or  al,00001000b ;set bit 3 -->high
out dx,al
```

[RED LED ON]

```
mov dx,48Fh          ;( IO_PORT = 48Fh)
in  al,dx
or  al,00010000b ;set bit 4 -->high
out dx,al
```

```
mov dx,4B8h          ;( IO_PORT = 4B8h)
in  al,dx
and al,11110111b ;set bit 3 -->LOW
```

```
out dx,al
```

[RED LED BLINK]

```
mov dx,48Fh          ;( IO_PORT = 48Fh)
```

```
in al,dx
```

```
or al,00010000b ;set bit 4 -->high
```

```
out dx,al
```

```
mov dx,4B8h          ;( IO_PORT = 4B8h)
```

```
in al,dx
```

```
and al,11110111b ;set bit 3 -->low
```

```
out dx,al
```

```
mov dx,49Bh          ;( IO_PORT = 49Bh)
```

```
in al,dx
```

```
or al,00010000b ;set bit 4 -->high(control blink)
```

```
out dx,al
```

[GREEN LED ON]

```
mov dx,48Fh          ;( IO_PORT = 48Fh)
```

```
in al,dx
```

```
and al,11101111b ;set bit 4 -->low
```

```
out dx,al
```

```
mov dx,4B8h          ;( IO_PORT = 4B8h)
```

```
in  al,dx
or   al,00001000b ;set bit 3 -->high
out dx,al
```

[GRN LED BLINK]

```
mov dx,48Fh          ;( IO_PORT = 48Fh)
in  al,dx
and al,11101111b ;set bit 4 -->low
out dx,al
```

```
mov dx,4B8h          ;( IO_PORT = 4B8h)
in  al,dx
or   al,00001000b ;set bit 3 -->high
out dx,al
```

```
mov dx,49Bh          ;( IO_PORT = 49Bh)
in  al,dx
or   al,00010000b ;set bit 4 -->high(control blink)
out dx,al
```

C.3 LAN Bypass Mode Sample Code

LAN BYPASS MODE Sample code

[Disable Function]

```
mov dx,48dh          ;( IO_PORT = 48dh)
in  al,dx
or  al,01000000b ;set bit 7-->high
out dx,al
```

```
mov dx,48Fh         ;( IO_PORT = 48Fh)
in  al,dx
and al,11111011b ;set bit 2-->low
out dx,al
```

[Force Mode]

```
mov dx,48dh          ;( IO_PORT = 48dh)
in  al,dx
and al,10111111b ;set bit 7-->low
out dx,al
```

```
mov dx,48Fh         ;( IO_PORT = 48Fh)
in  al,dx
and al,11111011b ;set bit 2-->low
out dx,al
```

[Watch Dog Mode]

```
mov dx,48dh                ;( IO_PORT = 48dh)
```

```
in  al,dx
```

```
or  al,01000000b ;set bit 7-->high
```

```
out dx,al
```

```
mov dx,48Fh                ;( IO_PORT = 48Fh)
```

```
in  al,dx
```

```
or  al,00000100b ;set bit 2-->high
```

```
out dx,al
```

C.4 LCM Sample Code

```
void Display_Clear()
{
    outportb(0x378, 0x01);
    wait();
    outportb(0x37A, 0xC8);
    wait();
    outportb(0x37A, 0xCA);
    wait();
}

void Return_Home()
{
    outportb(0x378, 0x02);
    wait();
    outportb(0x37A, 0xC8);
    wait();
    outportb(0x37A, 0xCA);
    wait();
}
```

```
}
```

```
void Entry_mode_set()
```

```
{
```

```
    outportb(0x378, 0x06);
```

```
    wait();
```

```
    outportb(0x37A, 0xC8);
```

```
    wait();
```

```
    outportb(0x37A, 0xCA);
```

```
    wait();
```

```
}
```

```
void Display_Off()
```

```
{
```

```
    outportb(0x378, 0x08);
```

```
    wait();
```

```
    outportb(0x37A, 0xC8);
```

```
    wait();
```

```
    outportb(0x37A, 0xCA);
```

```
        wait();
    }

void Display_On_Cursor_Off()
{
    outportb(0x378, 0x0C);
    wait();
    outportb(0x37A, 0xC8);
    wait();
    outportb(0x37A, 0xCA);
    wait();
}

void Display_On_Cursor_On()
{
    outportb(0x378, 0x0E);
    wait();
    outportb(0x37A, 0xC8);
    wait();
}
```



```
        outportb(0x37A, 0xCA);

        wait();

    }

/*****
***/

// Set the interface data length.

// Number of display line and character font.

// For 5x7 dots and 2 lines display now.

/*****
***/

void Function_Set()

{

    outportb(0x378, 0x38);

    wait();

    outportb(0x37A, 0xC8);

    wait();

    outportb(0x37A, 0xCA);
```

```
    wait();  
}
```

```
void Write_Char( char x )  
{  
    outportb(0x378, x);  
    outportb(0x37A, 0xC0);  
    wait();  
    outportb(0x37A, 0xC2);  
    wait();  
}
```

```
void Change_Line()  
{  
    outportb(0x378, 0xC0);  
    wait();  
    outportb(0x37A, 0xC8);  
    wait();  
    outportb(0x37A, 0xCA);
```

```
        wait();
    }

void wait()
{
    for (int i = 0 ; i < 0x10 ; i++)
    {
        for (int j = 0 ; j < 0x80 ; j++)
        {
            outportb(0x0EB, 0Xff);
        }
    }
}
```

C.5 Console Redirection

Console redirection allows you to maintain a system from a remote location by re-directing keyboard input and text output through the serial port. This section will tell you how to use the console redirection.

1. Please insert console cable between on FWS-7800 and remote client system.

2. Setup BIOS in FWS-7800.

BIOS >> advanced BIOS features >> Baud Rate:
19200(Default)

BIOS >> advanced BIOS features >> Console Redirection:
Enable (Default)

Enabled	Attempt to redirect console via COM port
Disabled	Console redirection function disabled

3. Configure Console redirection on client system. This example is for Windows platform.

Step1 - Click the Start button, point to programs >> Accessories >> Communication, and click Hyper Terminal

Step2 - Enter any name for the new connection and select any icon

Step3 - Click OK

Step4 - From the connect to pull-down menu, select a COM port available on your client system and click OK

Step5 - Select Baud Rate >> 19200, Flow control >> None, Data bit >>8, Parity cheek >> None, Stop bit>>1

4. Power on FWS-7800 and it will display the BIOS information on the client system.