EmETXe-i2309

**COM Express® Compact
Type 6 CPU Module**

User's Manual
Version 1.0

Revision History

Version	Date	Description
1.0	Dec, 2014	Initial release

Table of Contents

Preface	iii
Copyright Notice	iii
Declaration of Conformity	iii
CE	iii
FCC Class A	iii
RoHS	iv
SVHC / REACH	iv
Warning	v
Replacing the Lithium Battery	v
Technical Support	v
Warranty	vi
Chapter 1 - Introduction	1
1.1 The Product	2
1.2 About This Manual	2
1.3 Specifications	3
1.4 Inside the Package	4
1.5 Ordering Information	4
1.5.1 Optional Accessories	4
Chapter 2 - Board Overview	7
2.1 What Is “COM Express®”?	8
2.2 Board Dimensions	9
2.3 Block Diagram	10
2.4 Connector Pin Definition	11
Chapter 3 - Installation & Maintenance	15
3.1 Installing the CPU Module on Carrier Board	16
Chapter 4 - BIOS	17
4.1. Main	19
4.2. Advanced	20
4.2.1. Boot Configuration	22
4.2.2. PCI Express Configuration	22
4.2.3. USB Configuration	22
4.2.4. Audio Configuration	23
4.2.5. LPSS & SCC Configuration	23
4.2.6. ISCT Configuration	24

- 4.2.7. Miscellaneous Configuration..... 24
- 4.2.8. Security Configuration 25
- 4.2.9. Video Configuration 25
- 4.2.10. Chipset Configuration 27
- 4.2.11. Thermal Configuration 27
- 4.2.12. System Component 28
- 4.2.13. SATA Configuration..... 29
- 4.2.14. Console Redirection 29
- 4.2.15. ACPI Table/Feature Control 30
- 4.2.16. SIO FINTEK71869E 31
- 4.3. Security 32
- 4.4. Power..... 33
 - 4.4.1 Advanced CPU Control 34
- 4.5. Boot..... 36
- 4.6. Exit 37
- Appendix 39**
 - Appendix A: Watchdog Timer (WDT) Setting 40
 - Appendix B. Digital I/O Setting (OEM Request)..... 42
 - Appendix C: I/O Port Address Map 44
 - Appendix D: Interrupt Request Lines (IRQ) 46
 - Appendix E: BIOS Memory Map 48

Copyright Notice

All Rights Reserved.

The information in this document is subject to change without prior notice in order to improve the reliability, design and function. It does not represent a commitment on the part of the manufacturer.

Under no circumstances will the manufacturer be liable for any direct, indirect, special, incidental, or consequential damages arising from the use or inability to use the product or documentation, even if advised of the possibility of such damages.

This document contains proprietary information protected by copyright. All rights are reserved. No part of this manual may be reproduced by any mechanical, electronic, or other means in any form without prior written permission of the manufacturer.

Declaration of Conformity CE

The CE symbol on your product indicates that it is in compliance with the directives of the Union European (EU). A Certificate of Compliance is available by contacting Technical Support.

This product has passed the CE test for environmental specifications when shielded cables are used for external wiring. We recommend the use of shielded cables. This kind of cable is available from ARBOR. Please contact your local supplier for ordering information.

This product has passed the CE test for environmental specifications. Test conditions for passing included the equipment being operated within an industrial enclosure. In order to protect the product from being damaged by ESD (Electrostatic Discharge) and EMI leakage, we strongly recommend the use of CE-compliant industrial enclosure products.

Warning

This is a class A product. In a domestic environment this product may cause radio interference in which case the user may be required to take adequate measures.

FCC Class A

This device complies with Part 15 of the FCC Rules. Operation is subject to the following two conditions:

- (1) This device may not cause harmful interference, and
- (2) This device must accept any interference received, including interference that may cause undesired operation.

NOTE:

This equipment has been tested and found to comply with the limits for a Class A digital device, pursuant to Part 15 of the FCC Rules. These limits are designed to provide reasonable protection against harmful interference when the equipment is operated in a commercial environment. This equipment generates, uses, and can radiate radio frequency energy and, if not installed and used in accordance with the instruction manual, may cause harmful interference to radio communications. Operation of this equipment in a residential area is likely to cause harmful interference in which case the user will be required to correct the interference at his own expense.

RoHS

ARBOR Technology Corp. certifies that all components in its products are in compliance and conform to the European Union's Restriction of Use of Hazardous Substances in Electrical and Electronic Equipment (RoHS) Directive 2002/95/EC.

The above mentioned directive was published on 2/13/2003. The main purpose of the directive is to prohibit the use of lead, mercury, cadmium, hexavalent chromium, polybrominated biphenyls (PBB), and polybrominated diphenyl ethers (PBDE) in electrical and electronic products. Member states of the EU are to enforce by 7/1/2006.

ARBOR Technology Corp. hereby states that the listed products do not contain unintentional additions of lead, mercury, hex chrome, PBB or PBDB that exceed a maximum concentration value of 0.1% by weight or for cadmium exceed 0.01% by weight, per homogenous material. Homogenous material is defined as a substance or mixture of substances with uniform composition (such as solders, resins, plating, etc.). Lead-free solder is used for all terminations (Sn(96-96.5%), Ag(3.0-3.5%) and Cu(0.5%)).

SVHC / REACH

To minimize the environmental impact and take more responsibility to the earth we live, Arbor hereby confirms all products comply with the restriction of SVHC (Substances of Very High Concern) in (EC) 1907/2006 (REACH --Registration, Evaluation, Authorization, and Restriction of Chemicals) regulated by the European Union.

All substances listed in SVHC < 0.1 % by weight (1000 ppm)

Warning

Single Board Computers and their components contain very delicate Integrated Circuits (IC). To protect the Single Board Computer and its components against damage from static electricity, you should always follow the following precautions when handling it :

1. Disconnect your Single Board Computer from the power source when you want to work on the inside.
2. Hold the board by the edges and try not to touch the IC chips, leads or circuitry.
3. Use a grounded wrist strap when handling computer components.
4. Place components on a grounded antistatic pad or on the bag that comes with the Single Board Computer, whenever components are separated from the system.

Replacing the Lithium Battery

Incorrect replacement of the lithium battery may lead to a risk of explosion.

The lithium battery must be replaced with an identical battery or a battery type recommended by the manufacturer.

Do not throw lithium batteries into the trash-can. It must be disposed of in accordance with local regulations concerning special waste.

Technical Support

If you have any technical difficulties, please consult the user's manual first at: <ftp://ftp.arbor.com.tw/pub/manual>

Please do not hesitate to call or e-mail our customer service when you still cannot find out the answer.

<http://www.arbor.com.tw>

E-mail:info@arbor.com.tw

Warranty

This product is warranted to be in good working order for a period of two years from the date of purchase. Should this product fail to be in good working order at any time during this period, we will, at our option, replace or repair it at no additional charge except as set forth in the following terms. This warranty does not apply to products damaged by misuse, modifications, accident or disaster.

Vendor assumes no liability for any damages, lost profits, lost savings or any other incidental or consequential damage resulting from the use, misuse of, or inability to use this product. Vendor will not be liable for any claim made by any other related party.

Vendors disclaim all other warranties, either expressed or implied, including but not limited to implied warranties of merchantability and fitness for a particular purpose, with respect to the hardware, the accompanying product's manual(s) and written materials, and any accompanying hardware. This limited warranty gives you specific legal rights.

Return authorization must be obtained from the vendor before returned merchandise will be accepted. Authorization can be obtained by calling or faxing the vendor and requesting a Return Merchandise Authorization (RMA) number. Returned goods should always be accompanied by a clear problem description.



Chapter 1

Introduction

1.1 The Product

The EmETXe-i2309 is a space-conscious CPU board of 95 mm x 95 mm to take up only small footprint in your system. By the architecture of Type 6, the board has two high-performance connectors to promise stable data passing rate. The soldered onboard Intel® Atom™ processor E3845, along with integrated Intel® HD Graphics Gen7 graphics chipset, bring Analog RGB, LVDS and DDI solution for most CRT monitors or LCD video panels.

For system configuration, the board is supported by Insyde UEFI BIOS. EmETXe-i2309 is an ideal choice for some demanding industrial control and data communications by its significant processing performance, low power consumption and these features:

- Soldered onboard Intel® Atom™ processor E3845
- Intel i210IT PCIe GbE controller
- Dual Channels 24-bit LVDS, Analog RGB, and 1 x DisplayPort
- **Extended Operating Temp.:** -20 ~ 70°C
- **Wide Range Operating Temp.:** -40 ~ 85°C (WT series)

1.2 About This Manual

This user's manual provides general information and installation instructions about the product. This user's manual is intended for experienced users and integrators with hardware knowledge of personal computers. If you are not sure about any description in this booklet. Please consult your vendor before further handling.

1.3 Specifications

System	
CPU	Soldered onboard Intel® Atom™ processor E3845 1.91GHz
Memory	1 x DDR3L SO-DIMM socket, supporting up to 8GB 1333MT/s SDRAM
BIOS	Insyde BIOS
Watchdog Timer	1~255 levels reset
I/O	
USB 2.0	8 x USB 2.0 ports
USB 3.0	1 x USB 3.0 port
Storage	2 x Serial ATA ports with 300MB/s HDD transfer rate 4GB/8GB/16GB eMMC 4.5 (OEM request)
Expansion Bus	7 x PCIe x1, LPC, SDIO
Ethernet Chipset	1 x Intel® i210IT PCIe GbE controller
Serial Port	1 x UART (RX/TX)
TPM	TPM supported (OEM request)
Audio	HD link
Display	
Graphics Chipset	Integrated Intel® Gen7 Graphics
Graphics Interface	Analog RGB, with resolution up to 2048x1536
	LCD: Dual Channels 24-bit LVDS, with resolution up to 1920x1200
	1 x DDI port
Mechanical & Environmental	
Power Requirement	DC 12V, 5VSB
Power Consumption	1.05A@12V with E3825 (Typical, with PBE-1702)
Operating Temp.	-20 ~ 70°C (-4 ~ 158°F) -40 ~ 85°C (-40 ~ 185°F, WT series)
Operating Humidity	10 ~ 95% @ 70°C (non-condensing) 10 ~ 95% @ 85°C (non-condensing, WT series)
Dimension (L x W)	95 x 95 mm (3.7" x 3.7")

1.4 Inside the Package

Before you begin installing your single board, please make sure that the following materials have been shipped:



1 x EmETXe-i2309 COM Express CPU Module



1 x Driver CD

1 x Quick Installation Guide

If any of the above items is damaged or missing, contact your vendor immediately.

1.5 Ordering Information

EmETXe-i2309-E3845	Intel® Atom™ processor E3845 COM Express® Compact Type 6 CPU module
EmETXe-i2309-WT-E3845 (BTO)*	Intel® Atom™ processor E3845 WT COM Express® Compact Type 6 CPU module

1.5.1 Optional Accessories

HS-2309-F2-NT*	Heat spreader without threaded standoffs 95x95x11mm, not compatible with WT series
CPF-0000-C1**	FAN, 4500RPM, 60x60x20mm
HS-0000-W4	Universal evaluation heatsink kit w/ thermal pad (125x95x22 mm, only used on a flat type heat spreader)
PBE-1702	COM Express® Type 6 evaluation carrier board with Super IO F71869ED in ATX form factor
CBK-04-1702-00	Cable kit 1 x SATA cable 2 x Serial port cables 1 x USB cable

*For Wide-Temperature series, it is suggested to use HS-2309-F2-NT in conjunction with HS-0000-W4. The user must cut the HS-0000-W4 thermal pad to the right size to fit the heat spreader.

**When installing CPF-0000-C1, It is suggested to use HS-2309-F2-NT in conjunction with HS-0000-W4 to attach the FAN.

Find Device Drivers on CD

The CPU module supports Windows 7 and 8. Find the necessary drivers on the CD that comes with your purchase. For different OS, the driver installation may vary slightly, but generally they are similar. **DO** install **Chipset**→**Graphic**→**Audio** before the rest to prevent errors.

Find the drivers on CD by the following paths:

Windows 8.1

Driver	Path
Chipset	\Chipset\SetupChipset_10.0.13_PC
Graphic	\Graphics\WIN8_32\15.33.22.3621
	\Graphics\WIN8_64\15.33.22.64.3621
Audio	\Audio\32bit_Win7_Win8_Win81_R275
	\Audio\64bit_Win7_Win8_Win81_R275
Ethernet	\Ethernet\Intel
GPIO	\GPIO\Kit 100882 20140211 windows 8.1 64\GPIO
TXE	\TXE\Installers
Serial IO	\Serial IO\SerialIO_Installer_Win8.1_64bit_WW23
MBI	\MBI\MBI Kit 58443 20140106_windows 8_8.132_64
WINUSB	\WINUSB

Windows 7

Driver	Path
Chipset	\Chipset\SetupChipset_10.0.13_PC
Graphic	\Graphics\WIN7_32\Intel_EMGD.WIN7_PC_Version_36_15_0_1073
	\Graphics\WIN7_64\Intel_EMGD.WIN7_PC_Version_37_15_0_1073
Audio	\Audio\32bit_Win7_Win8_Win81_R275
	\Audio\64bit_Win7_Win8_Win81_R275
Ethernet	\Ethernet\Intel
TXE	\TXE\Installers
GPIO	\GPIO\windows 7 32_64\Intel Atom E3800 Win7 IO Drivers_Gold_v1.0 package 501232_20140211
USB3.0	\USB3.0\Intel(R) USB 3.0 eXtensible Host Controller_Win7_32bit_64bit_R3.0.0.33
Serial IO	\Serial IO\Intel Processor IO Drivers_Win7_32bit_64bit_Gold_v2.0
WINUSB	\WINUSB

This page is intentionally left blank.



Chapter 2

Board Overview

2.1 What Is “COM Express®”?

With more and more demands on small and embedded industrial boards, a multi-functional COM (Computer-on-Module) surfaces as a great solution.

COM Express® supports seven pin-out types applying to Basic and Extended form factors:

Module Type 1 and 10 support single connector with two rows (220 pins).

Module Type 2, 3, 4, 5 and 6 support two connectors with four rows (440 pins).

EmETXe-i2309 is a Type-6 module.

Difference between Standard Type 6 and EmETXe-i2309 is listed as below:

Module Type	Standard Type 6	EmETXe-i2309
Connectors	2	2
Connector Rows	A, B, C, D	A, B, C, D
PCIe Lanes (Max)	24	7
LAN (Max)	1	1
Serial Ports (Max)	2	1
Digital Display I/F (Max)	3	1
USB 3.0 Ports (Max)	4	1

Row AB provides pins for PCI Express, SATA, LVDS, LCD channel, LPC bus, system and power management, VGA, LAN, and power and ground interfaces.

Row CD provides SDVO and legacy PCI and IDE signals next to additional PCI Express, LAN and power and ground signals. The COM are targeted at following applications:

- Retail & Advertising
- Medical
- Test & Measurement
- Gaming & Entertainment
- Industrial & Automation
- Military & Government
- Security

2.2 Board Dimensions

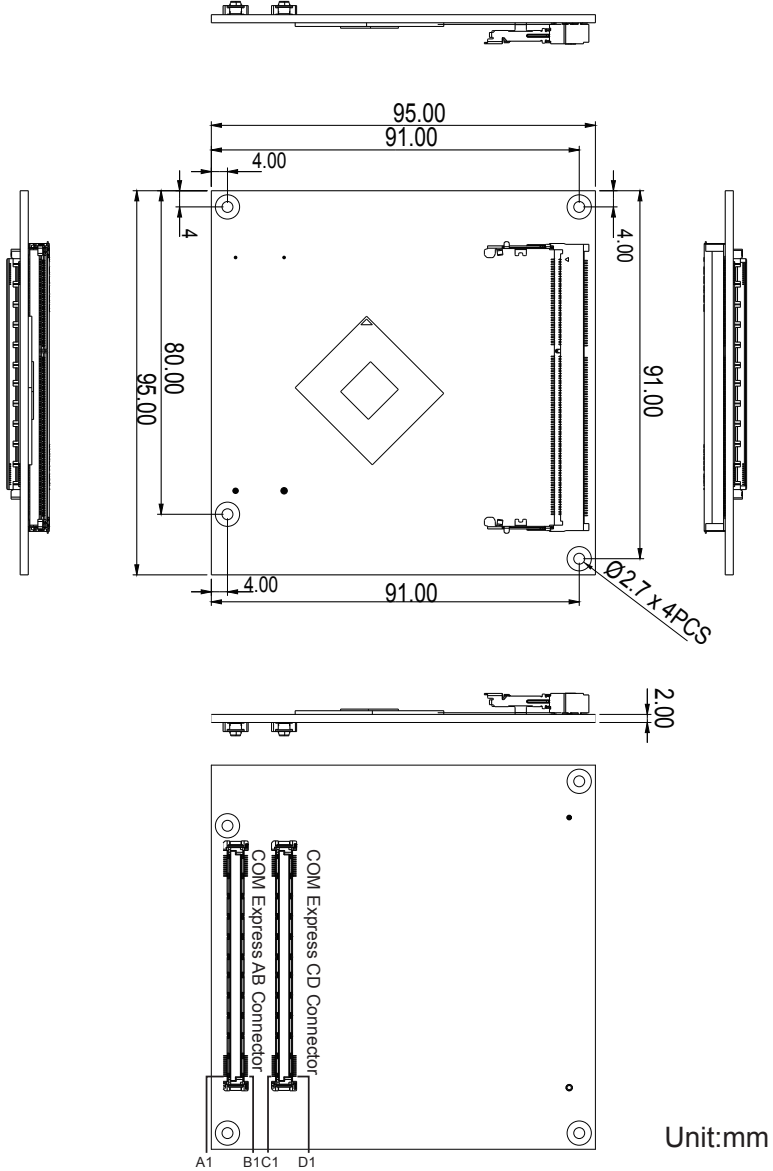

2.3 Block Diagram

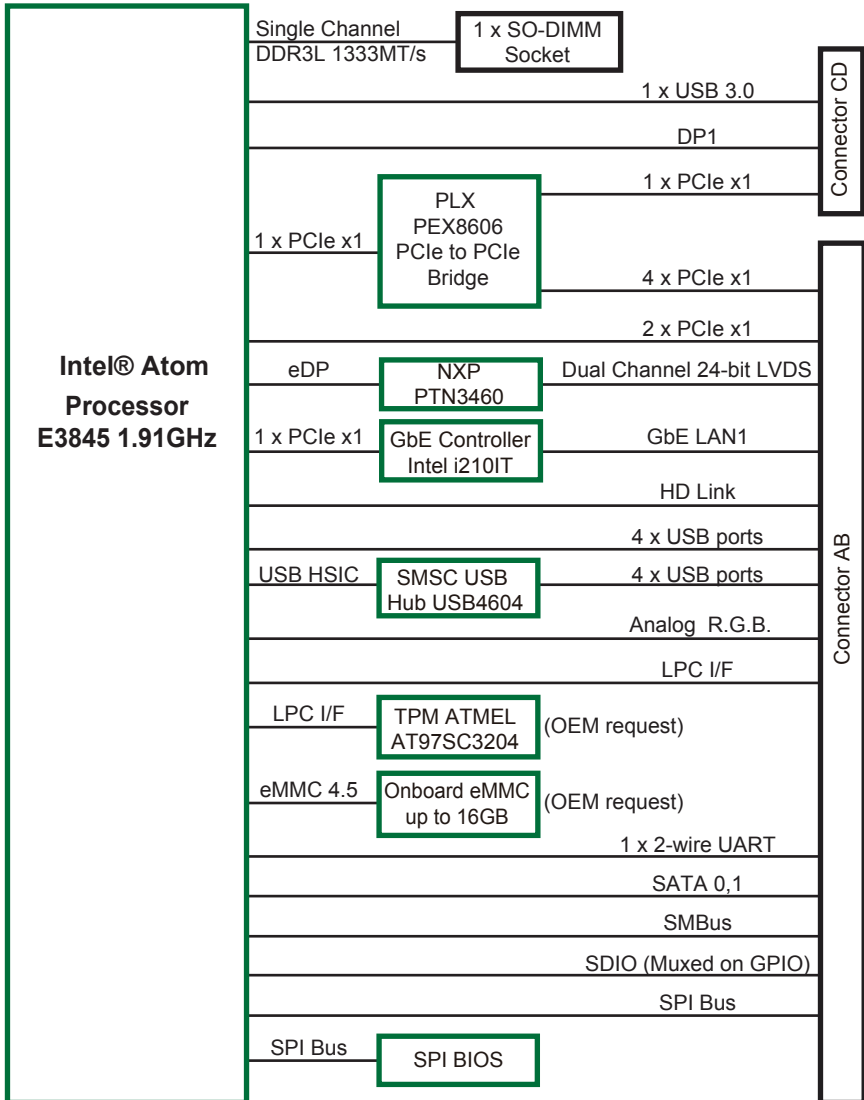

2.4 Connector Pin Definition

Being a most commonly-used Type 6, the EmETXe-i2309 features two board-to-board connectors on bottom side.

Top Side

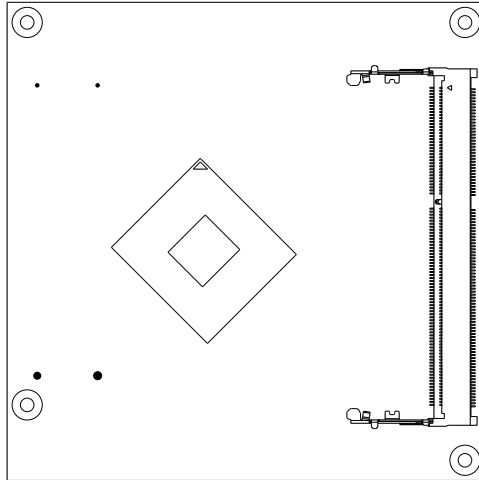

Bottom Side

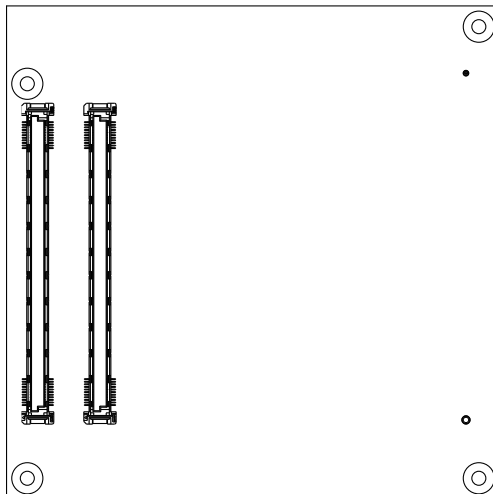

COM Express AB Connector (bottom side)

B1	GND (FIXED)	GND (FIXED)	A1	B56	PCIE_RX4-	PCIE_TX4-	A56
B2	GBE0_ACT#	GBE0_MDI3-	A2	B57	SD_WP or DIO6*	GND	A57
B3	LPC_FRAME#	GBE0_MDI3+	A3	B58	PCIE_RX3+	PCIE_TX3+	A58
B4	LPC_AD0	GBE0_LINK100#	A4	B59	PCIE_RX3-	PCIE_TX3-	A59
B5	LPC_AD1	GBE0_LINK1000#	A5	B60	GND	GND	A60
B6	LPC_AD2	GBE0_MDI2-	A6	B61	PCIE_RX2+	PCIE_TX2+	A61
B7	LPC_AD3	GBE0_MDI2+	A7	B62	PCIE_RX2-	PCIE_TX2-	A62
B8	LPC_DRQ0#(N/C)	GBE0_LINK#(N/C)	A8	B63	SD_CD# or DIO7*	SD_DATA1 or DIO1*	A63
B9	LPC_DRQ1#(N/C)	GBE0_MDI1-	A9	B64	PCIE_RX1+	PCIE_TX1+	A64
B10	LPC_CLK	GBE0_MDI1+	A10	B65	PCIE_RX1-	PCIE_TX1-	A65
B11	GND (FIXED)	GND (FIXED)	A11	B66	WAKE0#	GND	A66
B12	PWRBTN#	GBE0_MDI0-	A12	B67	WAKE1#	SD_DATA2 or DIO2*	A67
B13	SMB_CK	GBE0_MDI0+	A13	B68	PCIE_RX0+	PCIE_TX0+	A68
B14	SMB_DAT	GBE0_CTREF(N/C)	A14	B69	PCIE_RX0-	PCIE_TX0-	A69
B15	SMB_ALERT#	SUS_S3#	A15	B70	GND	GND	A70
B16	SATA1_TX+	SATA0_TX+	A16	B71	LVDS_B0+	LVDS_A0+	A71
B17	SATA1_TX-	SATA0_TX-	A17	B72	LVDS_B0-	LVDS_A0-	A72
B18	SUS_STAT#	SUS_S4#	A18	B73	LVDS_B1+	LVDS_A1+	A73
B19	SATA1_RX+	SATA0_RX+	A19	B74	LVDS_B1-	LVDS_A1-	A74
B20	SATA1_RX-	SATA0_RX-	A20	B75	LVDS_B2+	LVDS_A2+	A75
B21	GND (FIXED)	GND (FIXED)	A21	B76	LVDS_B2-	LVDS_A2-	A76
B22	SATA3_TX+(N/C)	SATA2_TX+(N/C)	A22	B77	LVDS_B3+	LVDS_VDD_EN	A77
B23	SATA3_TX-(N/C)	SATA2_TX-(N/C)	A23	B78	LVDS_B3-	LVDS_A3+	A78
B24	PWR_OK	SUS_S5#	A24	B79	LVDS_BKLT_EN	LVDS_A3-	A79
B25	SATA3_RX+(N/C)	SATA2_RX+(N/C)	A25	B80	GND	GND	A80
B26	SATA3_RX-(N/C)	SATA2_RX-(N/C)	A26	B81	LVDS_B_CK+	LVDS_A_CK+	A81
B27	WDT	BATLOW#	A27	B82	LVDS_B_CK-	LVDS_A_CK-	A82
B28	AC_SDIN2(N/C)	ATA_ACT#	A28	B83	CKLVDS_BKLT_CTRL	LVDS_I2C_CK	A83
B29	AC_SDIN1	AC_SYNC	A29	B84	VCC_5V_SBY	LVDS_I2C_DAT	A84
B30	AC_SDINO	AC_RST#	A30	B85	VCC_5V_SBY	SD_DATA3 or DIO3*	A85
B31	GND	GND	A31	B86	VCC_5V_SBY	RSVD(N/C)	A86
B32	SPKR	AC_BITCLK	A32	B87	VCC_5V_SBY	RSVD(N/C)	A87
B33	I2C_CK	AC_SDOU	A33	B88	BIOS_DIS1#	PCIE0_CK_REF+	A88
B34	I2C_DAT	BIOS_DISABLE0#	A34	B89	VGA_RED	PCIE0_CK_REF-	A89
B35	THR#	THR#	A35	B90	GND	GND	A90
B36	USB7-	USB6-	A36	B91	VGA_GRN	SPL_POWER	A91
B37	USB7+	USB6+	A37	B92	VGA_BLU	SPL_MISO	A92
B38	USB_4_5_OC#	USB_6_7_OC#	A38	B93	VGA_HSYNC	SD_CLK or DIO4*	A93
B39	USB5-	USB4-	A39	B94	VGA_VSYNC	SPL_CLK	A94
B40	USB5+	USB4+	A40	B95	VGA_I2C_CK	SPL_MOSI	A95
B41	GND	GND	A41	B96	VGA_I2C_DAT	TPM_PP	A96
B42	USB3-	USB2-	A42	B97	SPL_CS#	TYPE10#(N/C)	A97
B43	USB3+	USB2+	A43	B98	RSVD(N/C)	SERR0_TX	A98
B44	USB_0_1_OC#	USB_2_3_OC#	A44	B99	RSVD(N/C)	SERR0_RX	A99
B45	USB1-	USB0-	A45	B100	GND	GND	A100
B46	USB1+	USB0+	A46	B101	FAN_PWMOUT	SERR1_TX(N/C)	A101
B47	EXCD1_PERST#	VCC_RTC	A47	B102	FAN_TACHIN(N/C)	SERR1_RX(N/C)	A102
B48	EXCD1_CPPE#	EXCD0_PERST#	A48	B103	SLEEP#	LID#	A103
B49	SYS_RESET#	EXCD0_CPPE#	A49	B104	VCC_12V	VCC_12V	A104
B50	CB_RESET#	LPC_SERIRQ	A50	B105	VCC_12V	VCC_12V	A105
B51	GND	GND	A51	B106	VCC_12V	VCC_12V	A106
B52	PCIE_RX5+	PCIE_TX5+	A52	B107	VCC_12V	VCC_12V	A107
B53	PCIE_RX5-	PCIE_TX5-	A53	B108	VCC_12V	VCC_12V	A108
B54	SD_CMD or DIO5*	SD_DATA0 or DIO0*	A54	B109	VCC_12V	VCC_12V	A109
B55	PCIE_RX4+	PCIE_TX4+	A55	B110	GND	GND	A110

* GPIO(OEM request) and SDIO share the same pins, including A54, A63, A67, A85, A93, B54, B57, and B63.

COM Express CD Connector (bottom side)

D1	GND (FIXED)	GND (FIXED)	C1	D56	PEG_TX1-(N/C)	PEG_RX1-(N/C)	C56
D2	GND	GND	C2	D57	TYPE2#	TYPE1#(N/C)	C57
D3	USB_SSTX0-	USB_SSRX0-	C3	D58	PEG_TX2+(N/C)	PEG_RX2+(N/C)	C58
D4	USB_SSTX0+	USB_SSRX0+	C4	D59	PEG_TX2-(N/C)	PEG_RX2-(N/C)	C59
D5	GND	GND	C5	D60	GND (FIXED)	GND (FIXED)	C60
D6	USB_SSTX1-(N/C)	USB_SSRX1-(N/C)	C6	D61	PEG_TX3+(N/C)	PEG_RX3+(N/C)	C61
D7	USB_SSTX1+(N/C)	USB_SSRX1+(N/C)	C7	D62	PEG_TX3-(N/C)	PEG_RX3-(N/C)	C62
D8	GND	GND	C8	D63	RSVD	RSVD	C63
D9	USB_SSTX2-(N/C)	USB_SSRX2-(N/C)	C9	D64	RSVD	RSVD	C64
D10	USB_SSTX2+(N/C)	USB_SSRX2+(N/C)	C10	D65	PEG_TX4+(N/C)	PEG_RX4+(N/C)	C65
D11	GND (FIXED)	GND (FIXED)	C11	D66	PEG_TX4-(N/C)	PEG_RX4-(N/C)	C66
D12	USB_SSTX3-(N/C)	USB_SSRX3-(N/C)	C12	D67	RSVD	RSVD	C67
D13	USB_SSTX3+(N/C)	USB_SSRX3+(N/C)	C13	D68	PEG_TX5+(N/C)	PEG_RX5+(N/C)	C68
D14	GND	GND	C14	D69	PEG_TX5-(N/C)	PEG_RX5-(N/C)	C69
D15	DDI1_CTRLCLK_AUX+	DDI1_PAIR6+(N/C)	C15	D70	GND (FIXED)	GND (FIXED)	C70
D16	DDI1_CTRLCLK_AUX-	DDI1_PAIR6-(N/C)	C16	D71	PEG_TX6+(N/C)	PEG_RX6+(N/C)	C71
D17	RSVD	RSVD	C17	D72	PEG_TX6-(N/C)	PEG_RX6-(N/C)	C72
D18	RSVD	RSVD	C18	D73	GND	GND	C73
D19	PCIE_TX6+	PCIE_RX6+	C19	D74	PEG_TX7+(N/C)	PEG_RX7+(N/C)	C74
D20	PCIE_TX6-	PCIE_RX6-	C20	D75	PEG_TX7-(N/C)	PEG_RX7-(N/C)	C75
D21	GND(FIXED)	GND(FIXED)	C21	D76	GND	GND	C76
D22	PCIE_TX7+(N/C)	PCIE_RX7+(N/C)	C22	D77	RSVD	RSVD	C77
D23	PCIE_TX7-(N/C)	PCIE_RX7-(N/C)	C23	D78	PEG_TX8+(N/C)	PEG_RX8+(N/C)	C78
D24	RSVD	DDI1_HPD	C24	D79	PEG_TX8-(N/C)	PEG_RX8-(N/C)	C79
D25	RSVD	DDI1_PAIR4+(N/C)	C25	D80	GND (FIXED)	GND (FIXED)	C80
D26	DDI1_PAIR0+	DDI1_PAIR4-(N/C)	C26	D81	PEG_TX9+(N/C)	PEG_RX9+(N/C)	C81
D27	DDI1_PAIR0-	RSVD	C27	D82	PEG_TX9-(N/C)	PEG_RX9-(N/C)	C82
D28	RSVD	RSVD	C28	D83	RSVD	RSVD	C83
D29	DDI1_PAIR1+	DDI1_PAIR5+(N/C)	C29	D84	GND	GND	C84
D30	DDI1_PAIR1-	DDI1_PAIR5-(N/C)	C30	D85	PEG_TX10+(N/C)	PEG_RX10+(N/C)	C85
D31	GND(FIXED)	GND (FIXED)	C31	D86	PEG_TX10-(N/C)	PEG_RX10-(N/C)	C86
D32	DDI1_PAIR2+	DDI2_CTRLCLK_AUX+	C32	D87	GND	GND	C87
D33	DDI1_PAIR2-	DDI2_CTRLCLK_AUX-	C33	D88	PEG_TX11+(N/C)	PEG_RX11+(N/C)	C88
D34	DDI1_DDC_AUX_SEL	DDI2_DDC_AUX_SEL	C34	D89	PEG_TX11-(N/C)	PEG_RX11-(N/C)	C89
D35	RSVD	RSVD	C35	D90	GND (FIXED)	GND (FIXED)	C90
D36	DDI1_PAIR3+	DDI3_CTRLCLK_AUX+(N/C)	C36	D91	PEG_TX12+(N/C)	PEG_RX12+(N/C)	C91
D37	DDI1_PAIR3-	DDI3_CTRLCLK_AUX-(N/C)	C37	D92	PEG_TX12-(N/C)	PEG_RX12-(N/C)	C92
D38	RSVD	DDI3_DDC_AUX_SEL(N/C)	C38	D93	GND	GND	C93
D39	DDI1_PAIR0+	DDI3_PAIR0+(N/C)	C39	D94	PEG_TX13+(N/C)	PEG_RX13+(N/C)	C94
D40	DDI1_PAIR0-	DDI3_PAIR0-(N/C)	C40	D95	PEG_TX13-(N/C)	PEG_RX13-(N/C)	C95
D41	GND(FIXED)	GND(FIXED)	C41	D96	GND	GND	C96
D42	DDI1_PAIR1+	DDI3_PAIR1+(N/C)	C42	D97	RSVD	RSVD	C97
D43	DDI1_PAIR1-	DDI3_PAIR1-(N/C)	C43	D98	PEG_TX14+(N/C)	PEG_RX14+(N/C)	C98
D44	DDI2_HPD(N/C)	DDI3_HPD(N/C)	C44	D99	PEG_TX14-(N/C)	PEG_RX14-(N/C)	C99
D45	RSVD	RSVD	C45	D100	GND (FIXED)	GND (FIXED)	C100
D46	DDI2_PAIR2+(N/C)	DDI3_PAIR2+(N/C)	C46	D101	PEG_TX15+(N/C)	PEG_RX15+(N/C)	C101
D47	DDI2_PAIR2-(N/C)	DDI3_PAIR2-(N/C)	C47	D102	PEG_TX15-(N/C)	PEG_RX15-(N/C)	C102
D48	RSVD	RSVD	C48	D103	GND	GND	C103
D49	DDI2_PAIR3+(N/C)	DDI3_PAIR3+(N/C)	C49	D104	VCC_12V	VCC_12V	C104
D50	DDI2_PAIR3-(N/C)	DDI3_PAIR3-(N/C)	C50	D105	VCC_12V	VCC_12V	C105
D51	GND (FIXED)	GND (FIXED)	C51	D106	VCC_12V	VCC_12V	C106
D52	PEG_TX0+(N/C)	PEG_RX0+(N/C)	C52	D107	VCC_12V	VCC_12V	C107
D53	PEG_TX0-(N/C)	PEG_RX0-(N/C)	C53	D108	VCC_12V	VCC_12V	C108
D54	PEG_LANE_RV#(N/C)	TYPE0#(N/C)	C54	D109	VCC_12V	VCC_12V	C109
D55	PEG_TX1+	PEG_RX1+(N/C)	C55	D110	GND (FIXED)	GND (FIXED)	C110

This page is intentionally left blank.



Chapter 3

Installation & Maintenance

3.1 Installing the CPU Module on Carrier Board

1. Find the COM Express connectors on carrier board PBE-1702, which is available in Section [1.5.1 Optional Accessories on page 4](#).
2. Embed EmETXe-i2309 into PBE-1702 via COM Express connectors as below; that is, COM Express AB to AB and CD to CD.

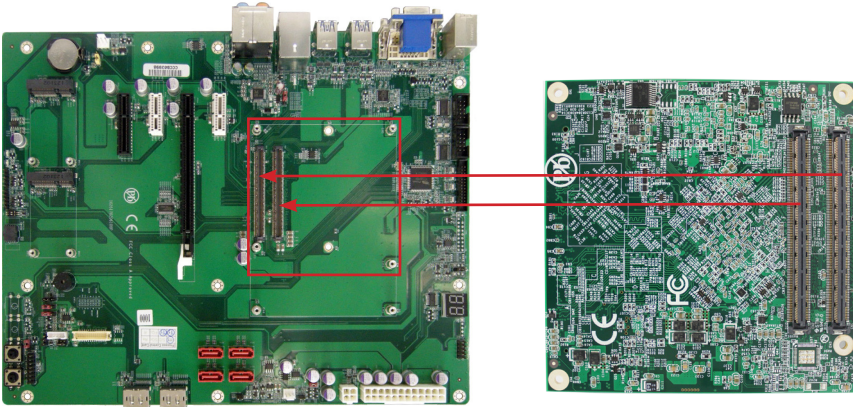



Chapter 4

BIOS

BIOS

The BIOS Setup utility is featured by Insyde BIOS to configure the system settings stored in the system's BIOS ROM. Insyde BIOS is activated once the computer powers on.

After entering the utility, use the left/right arrow keys to navigate between the top menus and use the down arrow key to access one.

Menu	Description
Main	See 4.1. Main on page 19 .
Advanced	See 4.2. Advanced on page 20 .
Security	See 4.3. Security on page 32 .
Power	See 4.4. Power on page 33 .
Boot	See 4.5. Boot on page 36 .
Exit	See 4.6. Exit on page 37 .

NOTE: For system stability and performance, this BIOS utility is constantly improved. The screenshots demonstrated and descriptions hereinafter are for reference only and may not exactly meet what is presented onscreen.

4.1. Main

The **Main** menu displays some BIOS info and features the settings of **System Date** and **System Time**.

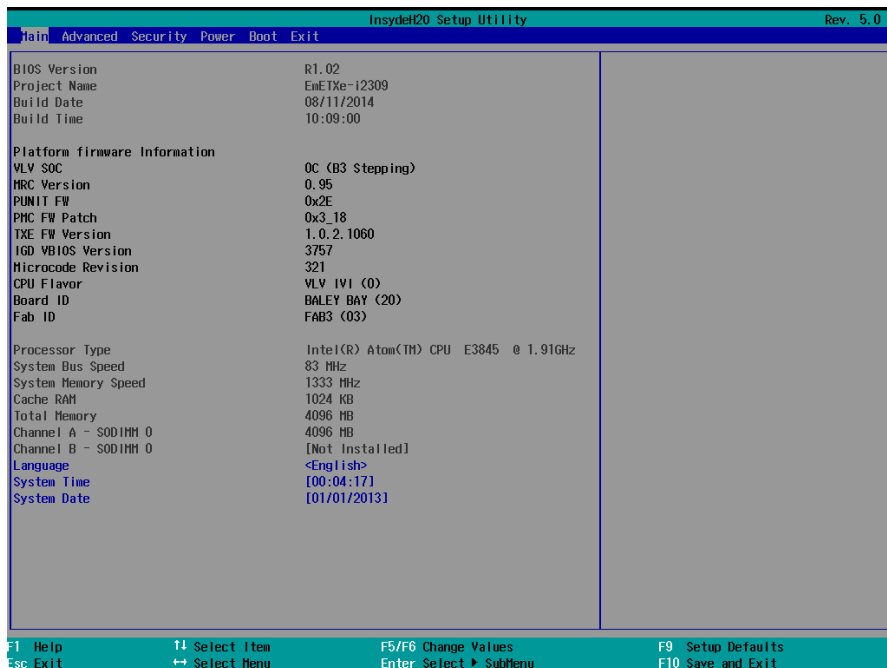

The BIOS info displayed is:

Info Item	Description
BIOS Version	Delivers the computer's BIOS version.
Project name	Delivers the name of the project
Build Date and Time	Delivers the date and time when the BIOS Setup utility was created/updated.
Platform firmware Information	Delivers the Platform firmware Information

The featured settings are:

Setting	Description
Language	Select the current default language used by the InsydeH20
System Time	Sets system time.
System Date	Sets system date.

4.2. Advanced

The **Advanced** menu controls the system’s CPU, IDE, Super IO, AHCI and USB. It also helps users monitor hardware health.

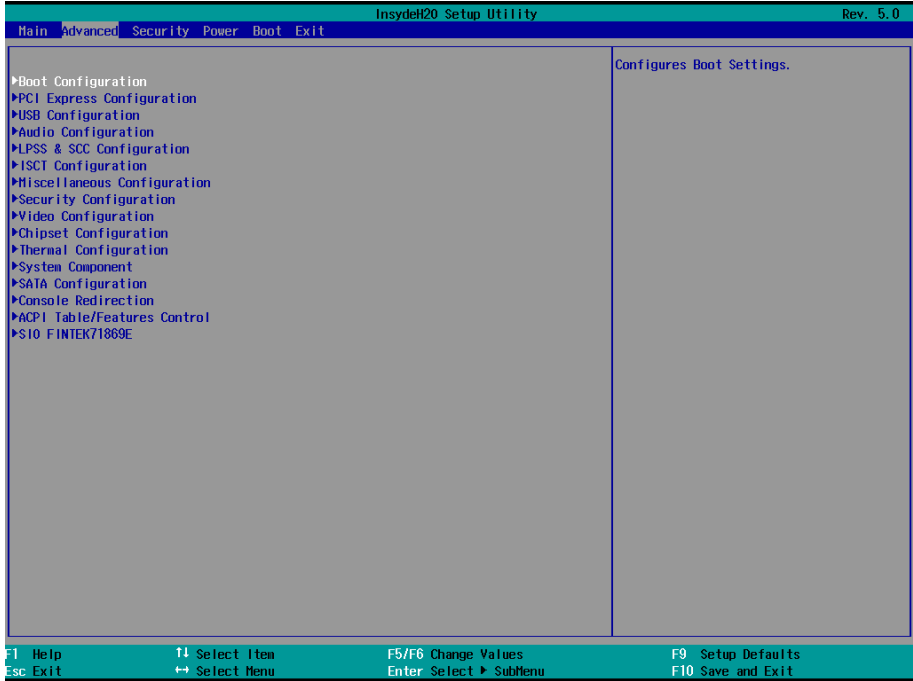

The featured submenus are:

Submenu	Description
Boot Configuration	See 4.2.1. Boot Configuration on page 22 .
PCI Express Configuration	See 4.2.2. PCI Express Configuration on page 22 .
USB Configuration	See 4.2.3. USB Configuration on page 22 .
Audio Configuration	See 4.2.4. Audio Configuration on page 23 .
LPSS & SCC Configuration	See 4.2.5. LPSS & SCC Configuration on page 23 .
ISCT Configuration	See 4.2.6. ISCT Configuration on page 24 .
Miscellaneous Configuration	See 4.2.7. Miscellaneous Configuration on page 24 .
Security Configuration	See 4.2.8. Security Configuration on page 25 .
Video Configuration	See 4.2.9. Video Configuration on page 25 .
Chipset Configuration	See 4.2.10. Chipset Configuration on page 27 .
Thermal Configuration	See 4.2.11. Thermal Configuration on page 27 .
System Component	See 4.2.12. System Component on page 28 .
SATA Configuration	See 4.2.13. SATA Configuration on page 29 .
Console Redirection	See 4.2.14. Console Redirection on page 29 .
ACPI Table/Feature Control	See 4.2.15. ACPI Table/Feature Control on page 30 .
SIO FINTEK71869E	See 4.2.16. SIO FINTEK71869E on page 31 .

4.2.1. Boot Configuration

Setting	Description
Numlock	Select Power-on state for Num lock

4.2.2. PCI Express Configuration

Configures PCI Express by the following settings:

Setting	Description
PCI Express Root Port 1/2/3/4	<ul style="list-style-type: none"> ▶ PCI Express Root Port Enables/disables this PCIe port. ▶ PCIe Speed Options are: Auto, Gen 1, Gen 2 Auto is the default. ▶ ASPM Support Options are: Disable : disables ASPM L0s : force all links to L0s state L1 : force all links to L1 state L0sL1 : force all links to L0s+L1 state Auto : BIOS auto configure

4.2.3. USB Configuration

Select this submenu to view the status of the USB ports and configure USB features.

The featured settings are:

Setting	Description
XHCI Pre-Boot Mode Support	Enables/Disables XHCI Pre-Boot mode support
xHCI Mode	Set the mode of operation of xHCI controller Options are Disabled/Enabled/Auto/Smart Auto(default)
XHCI Controller	Enables/Disables XHCI controller
USB2 Link Power Management	Enables/Disables USB2 Link Power Management.
XHCI Streams	Enables/disables XHCI Stream
USB OTG Support	Enables/disables USB OTG Support
USB VBUS	Turn ON/OFF USB VBUS. Turn ON in HOST mode, and turn OFF in OTG device mode.
USB RMH Mode	Enables/Disables PCH USB Rate Matching Hubs mode
USB Per-Port Control	Enables/Disables USB Per-port control

4.2.4. Audio Configuration

The featured settings are:

Setting	Description
LPE Audio Support	Enables/Disables LPE Audio mode Support
Audio Controller	Enables/Disables Azalia Controller
Azalia VCi Enable	Enables/Disables Virtual Channel 1 of Audio Controller
Azalia Docking Support Enable	Enables/Disables Azalia Docking Support of Audio Controller
Azalia PME Enable	Enables/Disables Power Management capability of Audio Controller
Azalia HDMI Codec	Enables/Disables Internal HDMI codec for Azalia

4.2.5. LPSS & SCC Configuration

The featured settings are:

Setting	Description
LPSS & SCC Device Mode	Set the mode of LPSS & SCC Device Options are ACPI mode(default)/PCI mode
OS Selection	Set the mode of OS Selection Options are Windows(default)/Android
SCC eMMC Boot Controller	Set the mode of eMMC Boot mode Options are Disable/ Auto Detect(Default)/ eMMC 4.41/ eMMC 4.5
eMMC Secure Erase	Enables/disables eMMC Secure Erase
SCC SDIO Support	Enables/disables SCC SDIO Support
SCC SD Card Supprt	Enables/disables SCC SD Card Supprt
SDR25 Capability Support for SDCard	Enables/disables SDR25 Capability Support for SDCard
DDR50 Capability Support for SDCard	Enables/disables DDR50 Capability Support for SDCard
LPSS DMA #1/2 Support	Enables/disables LPSS DMA #1/2 Support
LPSS I2C #1/2/3/4/5/6/7 Support	Enables/disables LPSS I2C #1/2/3/4/5/6/7 Support
LPSS HSUART #1/2	Enables/disables LPSS HSUART #1/2
LPSS PWM #1/2	Enables/disables LPSS PWM #1/2
LPSS SPI Support	Enables/disables LPSS SPI Support
I2C Touch Device Address	Set the I2C Touch Device Address Options are Auto(default)/0x4B/0x4A

NOTE: Windows 7 does not include any driver support for eMMC devices. If you select Windows 7 as your OS selection in BIOS, the eMMC device is disabled and grayed out.

4.2.6. ISCT Configuration

Setting	Description / Available Options
ISCT Configuration	Enables/Disables ISCT Configuration
WLAN Card Presence	
NGFF Card Inserted	Set "YES" if Next Generation Form Factor (NGFF) Card is inserted
UHPAM Card Inserted	Set "YES" if UHPAM Card is inserted.

4.2.7. Miscellaneous Configuration

The featured settings are:

Setting	Description / Available Options
HPET - HPET support	Enables/Disables HPET support in Windows XP
State After G3	Set the state of System when power is re-applied after a Power failure (G3 state) Options are S0 State(default)/S5 State
Clock Spread Spectrum	Enables/Disables Clock Spread Spectrum
Exl	Enables/Disables Exl
Bios Lock	Enables/Disables BIOS SPI region write protect
PCI MMIO Size	Set the Size of PCI MMIO Options are 2G(default)/0.75G/1G/1.25G/1.5G
PCI Express Dynamic Clock Gating	Enables/Disables PCI Express Dynamic Clock Gating
Force Legacy Free	Enables/Disables Force Legacy Free (Force Disable KBC)
Serial IRQ	Enables/Disables Serial IRQ
Serial IRQ Mode	Set the Mode of Serial IRQ Options are Quiet Mode(default)/Continuous Mode

4.2.8. Security Configuration

The featured settings are:

Submenu/Setting	Description
SPI Descriptor Override	Enables/Disables SPI Descriptor Override
TXE	Enables/Disables TXE
TXE HMRFP0	Enables/Disables TXE HMRFP0
TXE Firmware Update	Enables/Disables Firmware Update
TXE EOP Message	Enables/Disables Sending EOP Message Before OS
TXE Unconfiguration Perform	Enables/Disables TXE Temporary Disable function

4.2.9. Video Configuration

Configure video settings

The featured setting is:

4.2.9.1 Video Configuration

Setting	Description
Logo & SCU Resolution	Set Logo & SCU Resolution. Options are Auto/640 x480/800 x 600/1024 x 768

4.2.9.2 VBT Hook Configuration

Setting	Description
Configure CRT as	Set the option of CRT. Options are Default / CRT / No Device
CRT EDID Support	Enables/Disables CRT EDID Support
Configure DDI0 as	Set the option of DDI0. Options are Default/DisplayPort/ HDMI/DVI /DisplayPort with HDMI/ DVI Compatible / No Device
Configure DDI1 as	Set the option of DDI1. Options are Default/ LVDS/ DisplayPort/ HDMI/DVI /DisplayPort with HDMI/DVI Compatible / No Device
Configure eDP Panel Number as	Set the option of VBIOS eDP Panel Number. Options are 1,2,3,4,5,6,7,8,9,10,11,12,13,14,15,16.
LFP EDID Support	Enables/Disables LFP EDID Support
EFP EDID Support	Enables/Disables EFP EDID Support

4.2.9.3 PTN3460 (eDP to LVDS) Configuration

Setting	Description
PTN3460 Output Format	Set the Output Format of PTN3460. Options are (00) VESA (24bpp) / (01) VESA or JEIDA (18bpp) / (10) JEIDA (24bpp) / (11) JEIDA (24bpp)
PTN3460 Channel Control	Set the Channel mode of PTN3460. Options are Single/Dual.
PTN3460 EDID Table	Set the EDID Table of PTN3460.

4.2.9.4 GOP Configuration

Setting	Description
GOP Brightness Level	Set the Brightness Level of GOP.
GOP Driver	Enables/Disables GOP Driver

4.2.9.5 IGD Configuration

Setting	Description
Integrated Graphics Device	Enables/disables Integrated Graphics Device.
Primary Display	Set IGD or PCI graphic device as the Primary Display. Options are Auto/IGD/PCie.
RC6 (Render Standby)	Enables/Disables Render standby support.
PAVC	Enables/disables Protected Audio Video control
Power Management lock	Enables/disables Power management lock.
DOP CG	Enables/disables DOP Clock gating.
GTT Size	Set the GTT Size Options are 1MB/2MB
Aperture Size	Set the Aperture size Options are 128MB/256MB/512MB
IGD-DVMT Pre-Allocated	Set the DVMT5.0 Pre-Allocated (Fixed) Graphics Memory size used by the IGD.
IGD-DVMT total Gfx Mem	Set the size of DVMT 5.0 used by IGD
IGD Turbo	Enables/disables IGD Turbo
IGD Thermal	Enables/disables IGD Thermal
Spread Spectrum clock	Enables/disables Spread Spectrum clock

4.2.9.6 IGD- LCD Control

Setting	Description
Force Lid Status	Set mode of as the Primary Display. Options are ON (default) / OFF / Auto.
BIA	Set the mode of BIA. Options are Auto (default) /Disabled / Level 1 /Level 2 /Level 3 /Level 4 /Level 5.
ALS Support	Enables/Disables ALS support.
IGD Flat Panel	Set resolution of IGD Flat Panel.
IGD Boot Type	Set the Boot Type of IGD
Panel Scaling	Set the Scaling of Panel Options are Auto(default) / Centering / Stretching.
GMCH BLC Control	Set the mode of GMCH BLC Control Options are Auto(default) / PWM-Inverted / GMBus-Inverted / PWM-Normal / GMBus-Normal

4.2.10. Chipset Configuration

Setting	Description
ISP Enable/Disable	Enables/Disables ISP PCI device.
ISP PCI Device Selection	Set the mode of ISP PCI device. Options are Disabled(default) / ISP PCI Device as B0D2F0 (Windows startup)/ ISP PCI Device as B0D3F0 (Linux startup).

4.2.11. Thermal Configuration

Setting	Description
Critical Trip Point	Set the value of temperature of the ACPI critical Trip point When this point is reached, the OS will shut down the system
Passive Trip Point	Set the value of temperature of the ACPI Passive Trip point When this point is reached, the OS will begin to throttling the processor.
Active Trip Points	Set the value of temperature of the ACPI Active Trip point

4.2.12. System Component

Setting	Description
Power&Performance(PNP) Setting	Set the PNP Setting mode. Options are Disabled / Auto Detect / Ax Stepping / Bx Stepping When Auto detect mode is selected, system will load the PNP table against stepping.
CFIO PNP Setting	Enables/Disables CFIO PNP Setting mode. When the mode is enabled, CFIO unused pins will be in tri-state for power saving.
LPC Pin PNP Setting	Enables/Disables LPC Pin PNP Setting.
FSA ON	Set the FSA ON/OFF mode.
Enable WITT	Enables/Disables Windows Inter-Integrated Circuit (I2C) Testing Tool (WITT).
Enable UTS (Uart Test Suite)	Enables/Disables Uart Test Suite.
Lakemore Configuration	
Memory Allocation Size	Set the amount of memory to be reserved for Lakemore. Options are 0 KiB / 128 KiB / 1000 KiB / 8000 KiB / 16000 KiB.
PDM/Dfx Setting	Set the PDM/Dfx Setting mode. Options are PDM On / Perf Mode / Power Save / Debug Reserved
PDM Msg Output	Set the PDM Msg Output mode. Options are Disable / Main Memory / IO - TBD.
Enable DB2 Table	Enables/Disables DB2 Table.
PM Weights	Enables/Disables PM Weights.
Disable Codec ALC-262	Enables/Disables Codec ALC-262.

4.2.13. SATA Configuration

Select this submenu to configure the SATA controller and HD.

Setting	Description
SATA Controller(s)	Enables/disables the present SATA controller. ▶ Enabled is the default.
SATA Test Mode	Enables/disables the SATA test mode.
Configures SATA Mode	Set how to run the SATA drives. ▶ Options available are AHCI (default) and IDE .
SATA Port 0 Hot Plug Capability	Enables/disables hot-pluggable feature for the SATA port. ▶ Enabled is the default.
SATA Port 1 Hot Plug Capability	
SATA Port 0 Connect to an ODD	Enables/disables the SATA port connect to an ODD If enabled, when you connect an ODD to a SATA port. The software auto detection for media insert and tray will be enabled.
SATA Port 1 Connect to an ODD	▶ Disabled is the default.
Serial ATA Port 0	Delivers the SATA port Media information and Security Mode.
Serial ATA Port 1	

4.2.14. Console Redirection

Setting	Description
Console Serial Redirection	Enables/disables the Console Serial Redirection.
Information Wait Time	Set the Information Wait Time. Options are 0 Sec / 2 Sec / 5 Sec / 10 Sec / 30 Sec.
Serial Port	Enables/disables the present SATA controller.
Terminal Type	Set the Terminal Type: Options are ANSI : Extended ASCII char set. VT100 : ASCII char set. VT100+ : Extends VT100 to support color, functional keys, etc. VT-UTF8 : Uses UTF8 encoding to map unicode chars onto 1 or more bytes ANSI is the default.
Baud Rate	Set the Baud Rate Options are 1200 / 2400 / 4800 / 9600 / 14400 / 19200 / 28800 / 38400 / 57600 / 115200 (default).
Data Bits	Set the Data Bits Options are 7 Bits / 8 Bits (default)

<p>Parity</p>	<p>A parity bit can be sent with the data bits to detect some transmission errors. Even: parity bit is 0 if the num of 1's in the data bits is even. Odd: parity bit is 0 if num of 1's in the data bits is odd. Mark: parity bit is always 1. Space: Parity bit is always 0. Mark and space parity do not allow for error detection. They can be used as an additional data bit. ▶ None is the default.</p>
<p>Stop Bits</p>	<p>Stop bits indicate the end of a serial data packet. (A start bit indicates the beginning). The standard setting is 1 stop bit. Communication with slow devices may require more than 1 stop bit. Options are 1 Bit(default) / 2 Bit</p>
<p>Flow Control</p>	<p>Flow control can prevent data loss from buffer overflow. When sending data, if the receiving buffers are full, a 'stop' signal can be sent to stop the data flow. Once the buffers are empty, a 'start' signal can be sent to restart the flow. Hardware flow control uses two wires to send start/stop signals. Software flow control uses start/stop ASCII chars, which slows down the data flow and can be problematic if binary data is being sent. Options are None(default) / Hardware RTS / CTS.</p>
<p>C.R After Post</p>	<p>Enables/disables C.R After Post</p>
<p>ACPI SPCR Table</p>	<p>Enables/disables ACPI SPCR Table.</p>

4.2.15. ACPI Table/Feature Control

Setting	Description
<p>FACP - RTC S4 Wakeup</p>	<p>This function will be available only when ACPI is enabled. Enables/disables S4 Wakup from RTC.</p>
<p>APIC - IO APIC Mode</p>	<p>This item is valid only for WIN2K and WINXP. Also, a fresh install of the OS must occur when APIC mode is desired. Enables/disables the APIC mode</p>
<p>DSDT - ACPI S3</p>	<p>Enables/disables ACPI S3 state</p>
<p>DSDT - ACPI S4</p>	<p>Enables/disables ACPI S4 state</p>
<p>BGRT - ACPI BGRT</p>	<p>Enables/disables ACPI BGRT Table</p>

4.2.16. SIO FINTEK71869E

Configures SIO by the following settings:

Setting	Description
Power Loss mode	Set the state of Power Loss mode Options are Always On(default)/Always Off
Serial Port A/B/C/D	<ul style="list-style-type: none">▶ Serial Port Enables/disables the Serial port.▶ Base I/O Address Setup the Base I/O Address of the Serial Port.▶ Interrupt Setup the Interrupt of the Serial Port

4.3. Security

The **Security** menu sets up the password for the system’s administrator account. Once the administrator password is set up, this BIOS Setup utility is limited to access and will ask for the password each time any access is attempted.

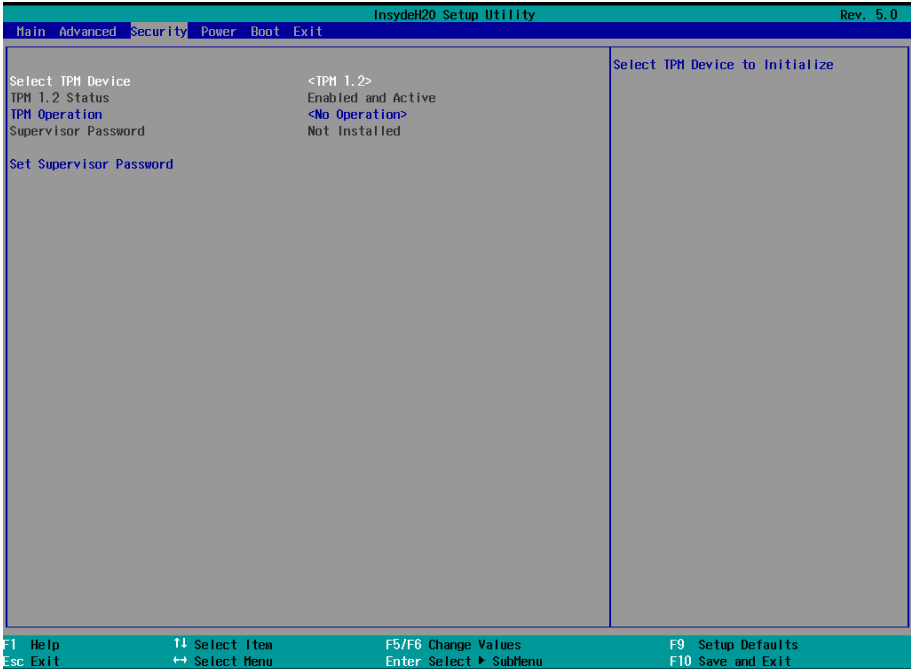

The featured setting is:

Setting	Description
Select TPM Device	Select TPM device to initialize if a TPM device is installed.
Set Supervisor Password	To set up an administrator password: 1. Select Set Supervisor Password . An Create New Password dialog then pops up onscreen. 2. Enter your desired password that is no less than 3 characters and no more than 20 characters. 3. Hit [Enter] key to submit.

4.4. Power

The **Power** menu sets up the power option of system

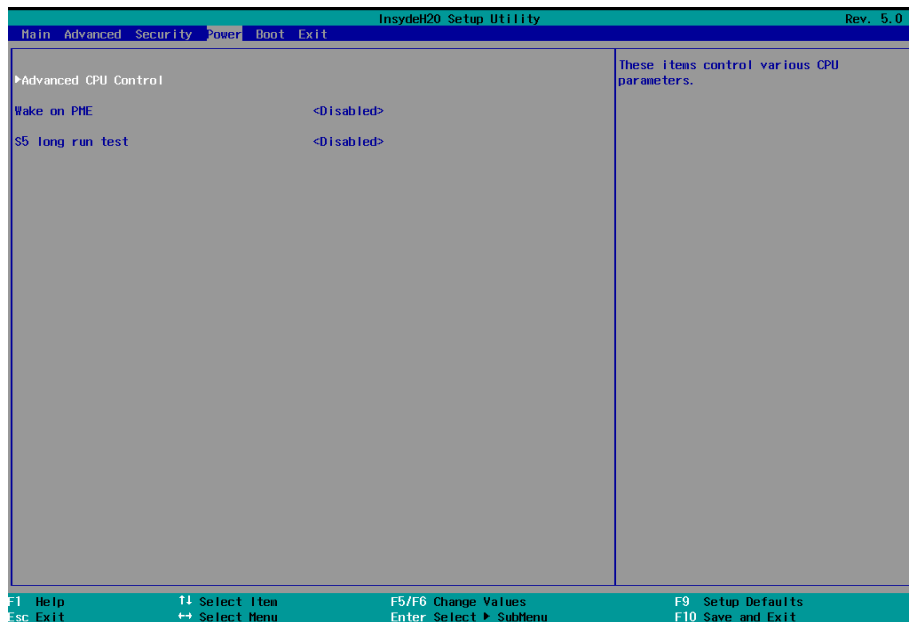

The featured setting is:

Setting	Description
Advanced CPU Control	See 4.4.1 Advanced CPU Control on page 34
Wake on PME	Enables or disables Wake on PME. Determines the action taken when the system power is off and a PCI Power Management Enable wake up event occurs.
S5 Long run test	If enabled, force the system to enable RTC S5 wake up, even if OS disable it. Support pwrtest to do RTC S5 wakeup. Options are Enabled/Disabled.

4.4.1 Advanced CPU Control

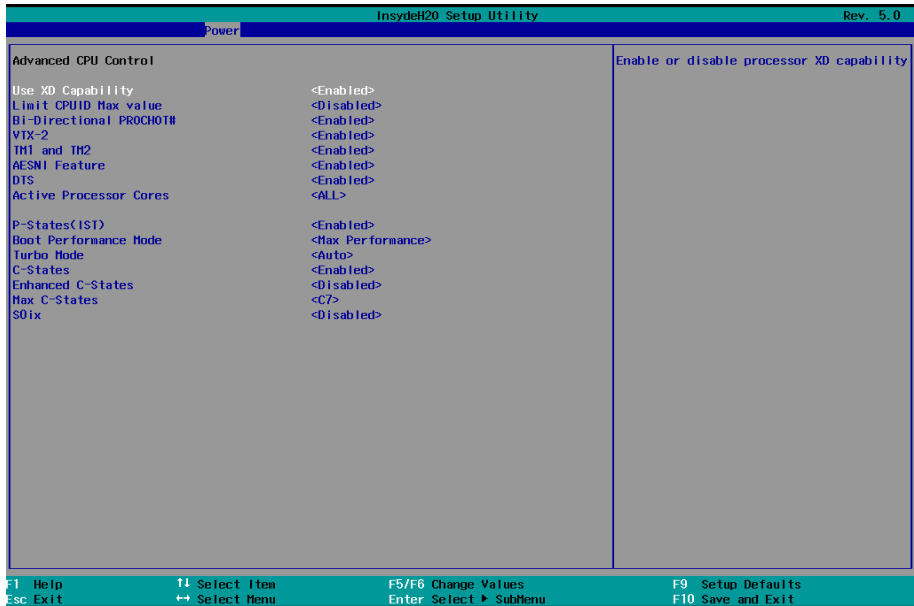

Setting	Description
Use XD Capability	Enables or disables processor XD capability.
Limit CPUID Max value	Sets whether the processor should limit the maximum CPUID input value to 03h when the operating system queries it upon startup. <ul style="list-style-type: none"> ▶ Select Enabled to allow a processor with Intel® Hyper-Threading technology to work with an operating system that doesn't support it. ▶ Disabled is the default.
Bi-Directional PROCHOT#	When a processor thermal sensor trips(either core), the PROCHOT# will be driven. If Bi-Directional is enable, external agents can drive PROCHOT# to throttle.
VTX-2	Enables/disables the CPU's VTX-2 function.
TM1 and TM2	Enable/disables TM1/TM2
AESNI Feature	Enable/disables AESNI
DTS	Enable/disables CPU Digital Thermal Sensor function.
Active Processor Cores	Set the Number of cores to enable in each processor package. Options are ALL/1
P-States(IST)	Enables/disables processor performance states (P-States)

Boot Performance Mode	Select the performance state that BIOS will set before OS hand-off
Turbo Mode	Enables/disables processor Turbo mode (EMTTM enabled is required)
C-States	Enables/disables processor idle power saving states (C-states)
Enhanced C-States	Enables/disables P-state transitions to occur in combination with C-states.
Max C-States	Set the Max CPC state C7/C6/C1
S0ix	Enables/disables the platform to configure S0ix support.

4.5. Boot

The **Boot** menu configures how to boot up the system such as the configuration of boot device priority.

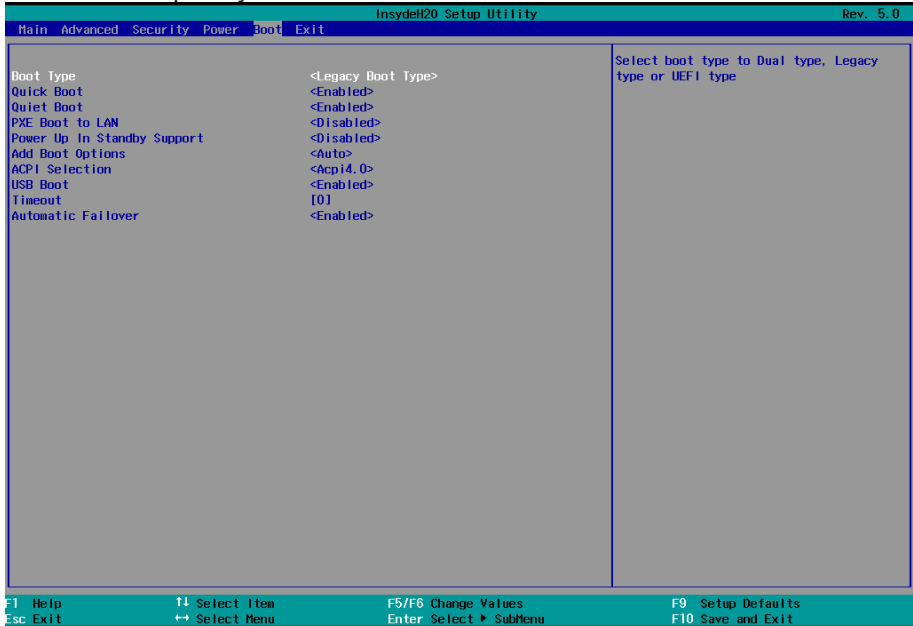

The featured settings are:

Setting	Description
Quick Boot	Allow InsydeH20 to Skip certain tests while booting . This will decrease the time need to boot the system.
Quiet Boot	Disables or enables booting in text mode.
PXE boot to LAN	Disables or enables PXE boot to LAN.
Power Up In Standby Support	Disable or enable Power Up In Standby Support.
Add Boot Option	Position in Boot Order for Shell, Network and Removables. Options are First, Last, and Auto.
APCI Selection	Select boot to Acpi 3.0/Acpi 1.0B Options are Acpi 1.0B/Acpi 3.0/Acpi 4.0/Acpi 5.0
USB Boot	Disables or enables booting to USB boot devices.
Timeout	Set the waiting seconds before booting the default boot selection
Automatic Failover	Enables/disables the Automatic Failover.

4.6. Exit

The **Save & Exit** menu features a handful of commands to launch actions from the BIOS Setup utility regarding saving changes, quitting the utility and recovering defaults.

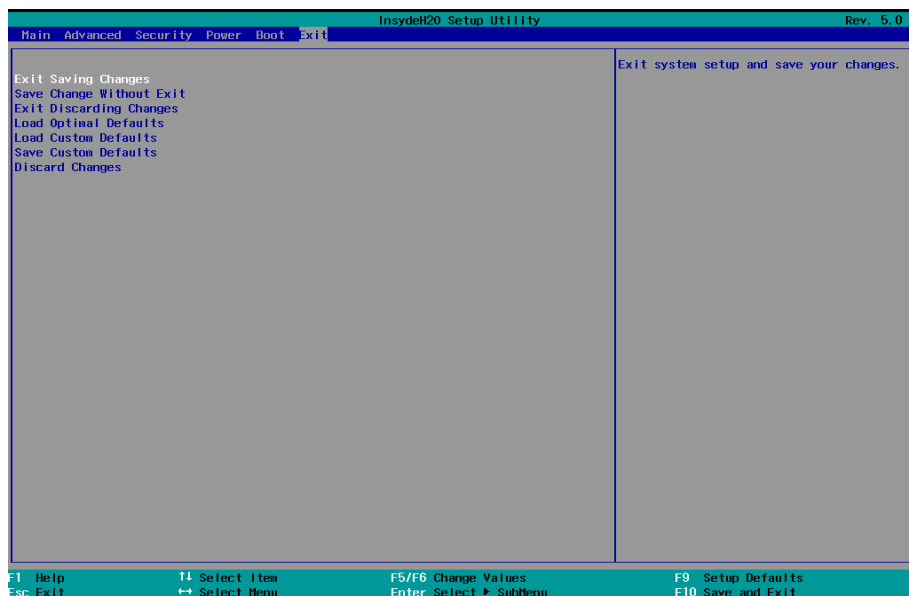

The features settings are:

Setting	Description
Exit Saving Changes	Saves the changes and quits the BIOS Setup utility.
Save Changes Without Exit	Save Changes but does not quit the BIOS.
Exit Discard Changes	Quits the BIOS Setup utility without saving the change(s).
Load Optimal Defaults	Restores all settings to defaults. ▶ This is a command to launch an action from the BIOS Setup utility rather than a setting.
Load Custom Default	Load custom default values
Save Custom Default	Save current setting as custom default
Discard Changes	Discard all changes without Exit.

This page is intentionally left blank.



Appendix

Appendix A: Watchdog Timer (WDT) Setting

WDT is widely used for industry application to monitor the activity of CPU. Application software depends on its requirement to trigger WDT with adequate timer setting. Before WDT time out, the functional normal system will reload the WDT. The WDT never time out for a normal system. The WDT will not be reloaded by an abnormal system, then WDT will time out and reset the system automatically to avoid abnormal operation.

This board supports 255 levels watchdog timer by software programming I/O ports. Below are the source codes written in C, please take them as WDT application example.

```
#include "math.h"
#include "stdio.h"
#include "dos.h"

int SMB_PORT_AD    = 0x2000;
int SMB_DEVICE_ADD = 0x6E;          /* 75111R's Add = 6eh or 9ch */

int main(void)
{
    int    iCount = 5;

    WDT_Start(iCount);

    while(1)
    {
        iCount = WDT_Count();
        printf("\r Counts : %d ",iCount);
        sleep(1);
    }

    return 0;
}

void WDT_Start(int iCount)
{
    int iData;

    /* Configuration and Control Register - Enable WDTOUT10# output */
    iData = SMB_Byte_READ(SMB_PORT_AD,SMB_DEVICE_ADD,0x01);
    iData = iData | 0x20;
    SMB_Byte_WRITE(SMB_PORT_AD,SMB_DEVICE_ADD,0x01,iData);

    /* Watchdog Timer Control Register */
    SMB_Byte_WRITE(SMB_PORT_AD,SMB_DEVICE_ADD,0x36,0x28);

    /* WDTOUT10 Control Register - Enable WDTOUT10 Output Timer */
```



```
        SMB_Byte_WRITE(SMB_PORT_AD, SMB_DEVICE_ADD, 0x35, (0x80|iCount));
    }

void WDT_Stop(void)
{
    /* Disable WDT timer, stop countdown */
    SMB_Byte_WRITE(SMB_PORT_AD, SMB_DEVICE_ADD, 0x35, 0x00);
}

void WDT_Clear(int iCount)
{
    /* Reset WDT Timeout Value */
    SMB_Byte_WRITE(SMB_PORT_AD, SMB_DEVICE_ADD, 0x35, (0x80|iCount));
}

int WDT_Count(void)
{
    int iData;

    iData = SMB_Byte_READ(SMB_PORT_AD, SMB_DEVICE_ADD, 0x35) & 0xFF7F;

    return iData;
}
```

Appendix B. Digital I/O Setting (OEM Request)

Digital I/O can read from or write to a line or an entire digital port, which is a collection of lines. This mechanism helps users achieve various applications such as industrial automation, customized circuit, and laboratory testing. Take the source code below that is written in C for the digital I/O application example.

Sample Codes:

```
#include "math.h"
#include "stdio.h"
#include "dos.h"

#define DELAY_TIME 10

int SMB_PORT_AD = 0x2000;
int SMB_DEVICE_ADD = 0x6E; /* 75111R's
Add = 6eh or 9ch */

unsigned char SMB_Byte_READ(int SMPORT, int DeviceID, int iREG_INDEX);
void SMB_Byte_WRITE(int SMPORT, int DeviceID, int oREG_INDEX, int oREG_DATA);

void main()
{
    int DataIn;

    SetDIOMode(0x0F);

    SetDIOData(0x0A);
    delay(2000);

    DataIn = GetDIOStatus();
    printf("\ Input : %2x \n",DataIn);
    delay(2000);

    SetDIOData(0x05);
    delay(2000);

    DataIn = GetDIOStatus();
    printf("\ Input : %2x \n",DataIn);
    delay(2000);
}

void SetDIOMode(int iMode)
{
    int iTemp;

    iTemp = iMode & 0x00FF;

    /* DIO 0 ~ 7 Mode */
    SMB_Byte_WRITE(SMB_PORT_AD,SMB_DEVICE_ADD,0x10,iTemp);
    delay(DELAY_TIME);
}
```

```
void SetDIOData(int iData)
{
    int iTemp;

    iTemp = iData & 0x00FF;

    /* DIO 0 ~ 7 Data */
    SMB_Byte_WRITE(SMB_PORT_AD, SMB_DEVICE_ADD, 0x11, iTemp);
    delay(DELAY_TIME);
}

int GetDIODStatus()
{
    int iStatus;

    iStatus = SMB_Byte_READ(SMB_PORT_AD, SMB_DEVICE_ADD, 0x12);
    /* DIO 0 ~ 7 Status */
    delay(DELAY_TIME);

    return iStatus;
}
```

Appendix C: I/O Port Address Map

Each peripheral device in the system is assigned a set of I/O port addresses which also becomes the identity of the device.

The following table lists the I/O port addresses used.

Address	Device Description
0x000003F8-0x000003FF	Communications Port (COM1)
0x000003E8-0x000003EF	Communications Port (COM2)
0x000002F8-0x000002FF	Communications Port (COM3)
0x00000378-0x0000037F	ECP Printer Port (LPT1)
0x00000778-0x0000077F	ECP Printer Port (LPT1)
0x00001000-0x00001FFF	Intel(R) Atom(TM)/Celeron(R)/Pentium(R) Processor PCI Express - Root Port 4 - 0F4E
0x00002000-0x0000201F	Intel(R) Atom(TM)/Celeron(R)/Pentium(R) Processor Platform Control Unit - SMBus Port - 0F12
0x00002050-0x00002057	Intel(R) HD Graphics
0x000003B0-0x000003BB	Intel(R) HD Graphics
0x000003C0-0x000003DF	Intel(R) HD Graphics
0x00000060-0x00000060	Microsoft PS/2 Mouse
0x00000064-0x00000064	Microsoft PS/2 Mouse
0x0000002E-0x0000002F	Motherboard resources
0x0000004E-0x0000004F	Motherboard resources
0x00000061-0x00000061	Motherboard resources
0x00000063-0x00000063	Motherboard resources
0x00000065-0x00000065	Motherboard resources
0x00000067-0x00000067	Motherboard resources
0x00000070-0x00000070	Motherboard resources
0x00000080-0x0000008F	Motherboard resources
0x00000092-0x00000092	Motherboard resources
0x000000B2-0x000000B3	Motherboard resources
0x00000680-0x0000069F	Motherboard resources
0x00000400-0x0000047F	Motherboard resources
0x00000500-0x000005FE	Motherboard resources
0x00000000-0x0000006F	PCI Express Root Complex

Address	Device Description
0x00000078-0x00000CF7	PCI Express Root Complex
0x00000D00-0x0000FFFF	PCI Express Root Complex
0x00000020-0x00000021	Programmable interrupt controller
0x00000024-0x00000025	Programmable interrupt controller
0x00000028-0x00000029	Programmable interrupt controller
0x0000002C-0x0000002D	Programmable interrupt controller
0x00000030-0x00000031	Programmable interrupt controller
0x00000034-0x00000035	Programmable interrupt controller
0x00000038-0x00000039	Programmable interrupt controller
0x0000003C-0x0000003D	Programmable interrupt controller
0x000000A0-0x000000A1	Programmable interrupt controller
0x000000A4-0x000000A5	Programmable interrupt controller
0x000000A8-0x000000A9	Programmable interrupt controller
0x000000AC-0x000000AD	Programmable interrupt controller
0x000000B0-0x000000B1	Programmable interrupt controller
0x000000B4-0x000000B5	Programmable interrupt controller
0x00002048-0x0000204F	Standard AHCI 1.0 Serial ATA Controller
0x0000205C-0x0000205F	Standard AHCI 1.0 Serial ATA Controller
0x00002040-0x00002047	Standard AHCI 1.0 Serial ATA Controller
0x00002058-0x0000205B	Standard AHCI 1.0 Serial ATA Controller
0x00002020-0x0000203F	Standard AHCI 1.0 Serial ATA Controller
0x000000B8-0x000000B9	Programmable interrupt controller
0x000000BC-0x000000BD	Programmable interrupt controller
0x000004D0-0x000004D1	Programmable interrupt controller
0x00000060-0x00000060	Standard PS/2 Keyboard
0x00000064-0x00000064	Standard PS/2 Keyboard
0x00000070-0x00000070	System CMOS/real time clock
0x00000040-0x00000043	System timer
0x00000050-0x00000053	System timer

Appendix D: Interrupt Request Lines (IRQ)

Peripheral devices use interrupt request lines to notify CPU for the service required. The following table shows the IRQ used by the devices on board.

Level	Function
IRQ 0	System timer
IRQ 1	Standard PS/2 Keyboard
IRQ 3	Communications Port (COM3)
IRQ 4	Communications Port (COM1)
IRQ 5	Communications Port (COM2)
IRQ 8	High Precision Event Timer
IRQ 11	Intel(R) Atom(TM)/Celeron(R)/Pentium(R) Processor Platform Control Unit - SMBus Port - 0F12
IRQ 11	Intel(R) Atom(TM)/Celeron(R)/Pentium(R) Processor Trusted Execution Engine Interface - 0F18
IRQ 12	Microsoft PS/2 Mouse
IRQ 16	Intel(R) Atom(TM)/Celeron(R)/Pentium(R) Processor PCI Express - Root Port 1 - 0F48
IRQ 17	Intel(R) Atom(TM)/Celeron(R)/Pentium(R) Processor PCI Express - Root Port 2 - 0F4A
IRQ 17	PCI standard PCI-to-PCI bridge
IRQ 18	Intel(R) Atom(TM)/Celeron(R)/Pentium(R) Processor PCI Express - Root Port 3 - 0F4C
IRQ 18	PCI standard PCI-to-PCI bridge
IRQ 18	PCI standard PCI-to-PCI bridge
IRQ 18	SDA Standard Compliant SD Host Controller
IRQ 19	Intel(R) Atom(TM)/Celeron(R)/Pentium(R) Processor PCI Express - Root Port 4 - 0F4E
IRQ 19	PCI standard PCI-to-PCI bridge
IRQ 19	PCI standard PCI-to-PCI bridge
IRQ 19	PCI standard PCI-to-PCI bridge
IRQ 22	High Definition Audio Controller
IRQ 23	SDA Standard Compliant SD Host Controller
IRQ 46	Intel SD Host Controller
IRQ 48	Intel(R) Atom(TM) Processor GPIO Controller

Level	Function
IRQ 49	Intel(R) Atom(TM) Processor GPIO Controller
IRQ 50	Intel(R) Atom(TM) Processor GPIO Controller
IRQ 81~511	Microsoft ACPI-Compliant System
IRQ 4294967287	Intel(R) I210 Gigabit Network Connection
IRQ 4294967288	Intel(R) I210 Gigabit Network Connection
IRQ 4294967289	Intel(R) I210 Gigabit Network Connection
IRQ 4294967290	Intel(R) I210 Gigabit Network Connection
IRQ 4294967291	Intel(R) I210 Gigabit Network Connection
IRQ 4294967292	Intel(R) I210 Gigabit Network Connection
IRQ 4294967293	Intel® USB 3.0 eXtensible Host Controller - 0100 (Microsoft)
IRQ 4294967294	Intel(R) HD Graphics

Appendix E: BIOS Memory Map

Address	Device Description
0x90810000-0x90813FFF	High Definition Audio Controller
0xFED00000-0xFED003FF	High Precision Event Timer
0x90900000-0x90900FFF	Intel SD Host Controller
0xFF000000-0xFFFFFFFF	Intel(R) 82802 Firmware Hub Device
0xFED0C000-0xFED0FFFF	Intel(R) Atom(TM) Processor GPIO Controller
0xFED0D000-0xFED0DFFF	Intel(R) Atom(TM) Processor GPIO Controller
0xFED0E000-0xFED0EFFF	Intel(R) Atom(TM) Processor GPIO Controller
0x90500000-0x9051FFFF	Intel(R) Atom(TM)/Celeron(R)/Pentium(R) Processor PCI Express - Root Port 3 - 0F4C
0x90400000-0x904FFFFF	Intel(R) Atom(TM)/Celeron(R)/Pentium(R) Processor PCI Express - Root Port 4 - 0F4E
0x90815000-0x9081501F	Intel(R) Atom(TM)/Celeron(R)/Pentium(R) Processor Platform Control Unit - SMBus Port - 0F12
0x90700000-0x907FFFFF	Intel(R) Atom(TM)/Celeron(R)/Pentium(R) Processor Trusted Execution Engine Interface - 0F18
0x90600000-0x906FFFFF	Intel(R) Atom(TM)/Celeron(R)/Pentium(R) Processor Trusted Execution Engine Interface - 0F18
0x90000000-0x903FFFFF	Intel(R) HD Graphics
0x80000000-0x8FFFFFFF	Intel(R) HD Graphics
0xA0000-0xBFFFF	Intel(R) HD Graphics
0x90400000-0x904FFFFF	Intel(R) I210 Gigabit Network Connection
0x90480000-0x90483FFF	Intel(R) I210 Gigabit Network Connection
0x90800000-0x9080FFFF	Intel® USB 3.0 eXtensible Host Controller - 0100 (Microsoft)
0xE0000000-0xEFFFFFFF	Motherboard resources
0xFED01000-0xFED01FFF	Motherboard resources
0xFED03000-0xFED03FFF	Motherboard resources
0xFED04000-0xFED04FFF	Motherboard resources
0xFED0C000-0xFED0FFFF	Motherboard resources
0xFED08000-0xFED08FFF	Motherboard resources
0xFED1C000-0xFED1CFFF	Motherboard resources
0xFEE00000-0xFEEFFFFFFF	Motherboard resources
0xFE000000-0xFEFFFFFFF	Motherboard resources
0xFED40000-0xFED44FFF	Motherboard resources
0x80000000-0x8FFFFFFF	PCI Express Root Complex
0xA0000-0xBFFFF	PCI Express Root Complex

Address	Device Description
0xC0000-0xDFFFF	PCI Express Root Complex
0xE0000-0xFFFFF	PCI Express Root Complex
0x90500000-0x9051FFFF	PCI standard PCI-to-PCI bridge
0x90817000-0x90817FFF	SDA Standard Compliant SD Host Controller
0x90816000-0x90816FFF	SDA Standard Compliant SD Host Controller
0x9081A000-0x9081AFFF	SDA Standard Compliant SD Host Controller
0x90819000-0x90819FFF	SDA Standard Compliant SD Host Controller
0xFED40000-0xFED44FFF	Trusted Platform Module 1.2
