ARTS-2870

Marine PC with Intel® Core™ i5-4402E

User's Manual

Version 1.0

P/N: 4012287000100P

2014.12



Revision History

Version	Release Time	Description
1.0	Dec 2014	Initial release

Preface	iii
Copyright Notice	iii
Declaration of Conformity	iii
CE	iii
FCC Class A.....	iii
RoHS	iv
SVHC / REACH	iv
Important Safety Instructions	v
Warning	v
Replacing Lithium Battery.....	vi
Technical Support	vi
Warranty	vii
Chapter 1 - Introduction	1
1.1. Product Highlights	2
1.2. About this Manual	2
1.3. Specifications	3
1.5. Ordering Information.....	5
1.5.1. Optional Accessories	5
1.5.2. Configure-to-Order Service.....	5
Chapter 2 - Getting Started	7
2.1. Dimensions.....	8
2.2. Take A Tour	9
2.3. Driver Installation Notes	11
Chapter 3 - System Configuration	13
3.1. Board Layout	14
3.1.1. CPU Boards	14
3.1.2. Carrier Board	16
3.2. Jumpers and Connectors	18
3.2.1. Jumpers	18
Chapter 4 - Installation and Maintenance	45
4.1. Install Hardware.....	46
4.1.1. Open the Computer	46
4.1.2. Install SATA SSD	47
4.1.3. Install Memory Module on CPU Module	49
4.2. Mount the Computer	50
4.3. Wire DC-in Power Source.....	52

Chapter 5 - BIOS 53

- 5.1. BIOS 56
 - 5.1.1. Main 56
 - 5.1.2. Advanced 57
 - 5.1.3. Chipset 67
 - 5.1.4. Boot 72
 - 5.1.5. Security 74
 - 5.1.6. Save & Exit 75

Appendices 77

- Appendix A: WiFi-AT2350 Hardware Installation 78
- Appendix B: Install mSATA Storage 83

Copyright Notice

All Rights Reserved.

The information in this document is subject to change without prior notice in order to improve the reliability, design and function. It does not represent a commitment on the part of the manufacturer.

Under no circumstances will the manufacturer be liable for any direct, indirect, special, incidental, or consequential damages arising from the use or inability to use the product or documentation, even if advised of the possibility of such damages.

This document contains proprietary information protected by copyright. All rights are reserved. No part of this document may be reproduced by any mechanical, electronic, or other means in any form without prior written permission of the manufacturer.

Declaration of Conformity

CE

The CE symbol on the computer indicates that it is in compliance with the directives of the Union European (EU). A Certificate of Compliance is available by contacting Technical Support.

This product has passed the CE test for environmental specifications when shielded cables are used for external wiring. We recommend the use of shielded cables. This kind of cable is available from ARBOR. Please contact your local supplier for ordering information.

Warning

This is a class A product. In a domestic environment this product may cause radio interference in which case the user may be required to take adequate measures.

FCC Class A

This device complies with Part 15 of the FCC Rules. Operation is subject to the following two conditions:

- (1) This device may not cause harmful interference, and
- (2) This device must accept any interference received, including interference that may cause undesired operation.

NOTE:

This equipment has been tested and found to comply with the limits for a Class A digital device, pursuant to Part 15 of the FCC Rules. These limits are designed to provide reasonable protection against harmful interference when the equipment is operated in a commercial environment. This equipment generates, uses, and can radiate radio frequency energy and, if not installed and used in accordance with the instruction manual, may cause harmful interference to radio communications. Operation of this equipment in a residential area is likely to cause harmful interference in which case the user will be required to correct the interference at his own expense.

RoHS

ARBOR Technology Corp. certifies that all components in its products are in compliance and conform to the European Union's Restriction of Use of Hazardous Substances in Electrical and Electronic Equipment (RoHS) Directive 2002/95/EC.

The above mentioned directive was published on 2/13/2003. The main purpose of the directive is to prohibit the use of lead, mercury, cadmium, hexavalent chromium, polybrominated biphenyls (PBB), and polybrominated diphenyl ethers (PBDE) in electrical and electronic products. Member states of the EU are to enforce by 7/1/2006.

ARBOR Technology Corp. hereby states that the listed products do not contain unintentional additions of lead, mercury, hex chrome, PBB or PBDB that exceed a maximum concentration value of 0.1% by weight or for cadmium exceed 0.01% by weight, per homogenous material. Homogenous material is defined as a substance or mixture of substances with uniform composition (such as solders, resins, plating, etc.). Lead-free solder is used for all terminations (Sn(96-96.5%), Ag(3.0-3.5%) and Cu(0.5%)).

SVHC / REACH

To minimize the environmental impact and take more responsibility to the earth we live, Arbor hereby confirms all products comply with the restriction of SVHC (Substances of Very High Concern) in (EC) 1907/2006 (REACH --Registration, Evaluation, Authorization, and Restriction of Chemicals) regulated by the European Union.

All substances listed in SVHC < 0.1 % by weight (1000 ppm)

Important Safety Instructions

Read these safety instructions carefully

1. Read all cautions and warnings on the equipment.
2. Place this equipment on a reliable surface when installing. Dropping it or letting it fall may cause damage
3. Make sure the correct voltage is connected to the equipment.
4. For pluggable equipment, the socket outlet should be near the equipment and should be easily accessible.
5. Keep this equipment away from humidity.
6. The openings on the enclosure are for air convection and protect the equipment from overheating. **DO NOT COVER THE OPENINGS.**
7. Position the power cord so that people cannot step on it. Do not place anything over the power cord.
8. Never pour any liquid into opening. This may cause fire or electrical shock.
9. Never open the equipment. For safety reasons, the equipment should be opened only by qualified service personnel.
10. If one of the following situations arises, get the equipment checked by service personnel:
 - a. The power cord or plug is damaged.
 - b. Liquid has penetrated into the equipment.
 - c. The equipment has been exposed to moisture.
 - d. The equipment does not work well, or you cannot get it to work according to the user's manual.
 - e. The equipment has been dropped or damaged.
 - f. The equipment has obvious signs of breakage.
11. Keep this User's Manual for later reference.

Product Heat



The computer generates heat during operation. Contact the computer's chassis with your body could cause discomfort or even a skin burn.

Warning

The Box PC and its components contain very delicately Integrated Circuits (IC). To protect the Box PC and its components against damage caused by static electricity, you should always follow the precautions below when handling it:

1. Disconnect your Box PC from the power source when you want to work on the inside.
2. Use a grounded wrist strap when handling computer components.
3. Place components on a grounded antistatic pad or on the bag that came with the Box PC, whenever components are separated from the system.

Replacing Lithium Battery

Incorrect replacement of the lithium battery may lead to a risk of explosion.

The lithium battery must be replaced with an identical battery or a battery type recommended by the manufacturer.

Do not throw lithium batteries into the trash can. It must be disposed of in accordance with local regulations concerning special waste.

Technical Support

If you have any technical difficulties, please consult the user's manual first at:
<ftp://ftp.arbor.com.tw/pub/manual>

Please do not hesitate to call or e-mail our customer service when you still cannot find out the answer.

<http://www.arbor.com.tw>

E-mail:info@arbor.com.tw

Warranty

This product is warranted to be in good working order for a period of one year from the date of purchase. Should this product fail to be in good working order at any time during this period, we will, at our option, replace or repair it at no additional charge except as set forth in the following terms. This warranty does not apply to products damaged by misuse, modifications, accident or disaster.

Vendor assumes no liability for any damages, lost profits, lost savings or any other incidental or consequential damage resulting from the use, misuse of, or inability to use this product. Vendor will not be liable for any claim made by any other related party.

Vendors disclaim all other warranties, either expressed or implied, including but not limited to implied warranties of merchantability and fitness for a particular purpose, with respect to the hardware, the accompanying product's manual(s) and written materials, and any accompanying hardware. This limited warranty gives you specific legal rights.

Return authorization must be obtained from the vendor before returned merchandise will be accepted. Authorization can be obtained by calling or faxing the vendor and requesting a Return Merchandise Authorization (RMA) number. Returned goods should always be accompanied by a clear problem description.

This page is intentionally left blank.

Chapter 1

Introduction

1.1. Product Highlights

- **Fanless and rugged design**
- Isolated NMEA 0183
- Isolated RS-232/485 and DIO
- Support power on/off delay control
- Compliant with IEC-60945, IACS E10, DNV 2.4
- Support 3 Video outputs
- Support RAID 0/1



1.2. About this Manual

This manual is meant for the experienced users and integrators with hardware knowledge of personal computers. If you are not sure about the description herein, consult your vendor before further handling.

We recommend that you keep one copy of this manual for the quick reference for any necessary maintenance in the future. Thank you for choosing ARBOR products.

1.3. Specifications

System	
CPU	Soldered onboard Intel® Core™ i5-4402E 1.6GHz
Chipset	Intel® PCH QM87
Graphic	Integrated Intel® HD Graphics 4600
Memory	1 x 204-pin SO-DIMM sockets, supporting DDR3L 1333/1600 MHz, up to 8GB SDRAM
Storage	2 x Serial ATA ports with 300MB/s HDD transfer rate
	2 x Serial ATA ports with 600MB/s HDD transfer rate
Ethernet	1x Intel® i217LM GbE PHY (iAMT 9.0 supported)
	3 x Intel® i210IT GbE controllers
Watchdog Timer	1 ~ 255 levels reset
I/O Ports	
Serial Port	<ul style="list-style-type: none"> • 2 x RS-232/422/485 port with DB-9 connectors, rear side, 2 KV isolated protection • 8 x NMEA 0183 ports, rear side, 2 KV isolated protection
USB Port	<ul style="list-style-type: none"> • 2 x USB 3.0 ports type A connector, front side • 4 x USB 2.0 ports type A connector, rear side
LAN Port	4 x RJ-45 ports for Gigabit Ethernet
Video Port	1 x VGA DB-15 female connector for Analog RGB 2 x DVI-D female connector for Digital Video output
Digital I/O	1 x 8-bit digital I/O (4 in/4 out) with 10-pin terminal block , 2KV isolated protection
Audio	1 x Line-out with 3.5mm jack 1 x MIC-in with 3.5mm jack
Expansion Bus	<ul style="list-style-type: none"> • 1 x Mini-PCIe slot (half-size) • 1 x mSATA slot for internal mSATA SSD
Storage	
Type	<ul style="list-style-type: none"> • 2 x 2.5" drive bays for SATA SSD (1 x outside accessible SSD), support RAID 0/1 • 1 x mSATA
Qualification	
Certification	CE, FCC Class A Compliant with IEC-60945, IACS E10, DNV 2.4

Introduction

Environment	
Operating Temp.	-25 ~ 55°C (-13 ~ 131°F), ambient w/ air flow
Storage Temp.	-40~80°C (-40 ~ 185°F)
Relative Humidity	10 ~ 95% @ 55°C (non-condensing)
Vibration	<ul style="list-style-type: none">• 0.7 @ DNV 2.4 (Class A), sine wave, 2-100 Hz, 1 Oct./min., 1.5 hr per axis• 1 g @ DNV 2.4, random wave, 3-100 Hz, 2.5 hr per axis• 2.1 g @ DNV 2.4 (Class C), sine wave, 2-50 Hz, 1 Oct./min., 1.5 hr per axis
Shock	50 g @ IEC 60068-2-27, half sine wave, 11 ms
Mechanical	
Construction	Aluminum alloy
Mounting	Support wall-mount
Weight	5.7 Kg (12.56 lb)
Dimensions (W x D x H)	270.4 x 240 x 110 mm (10.65" x 9.45" x 4.33")
Power Requirement	
Power Input	DC 24V input, 2KV isolated protection
Power Consumption	Max. 60W

1.4. Inside the Package

Upon opening the package, carefully inspect the contents. If any of the items is missing or appears damaged, contact your local dealer or distributor. The package should contain the following items:



ARTS-2870

Fanless Marine PC



One Driver CD
One User's Manual

1.5. Ordering Information

ARTS-2870	Marine Barebone System w/ Intel® Core™ i5-4402E , w/o memory and storage
------------------	---

1.5.1. Optional Accessories





The following items are normally optional, but some vendors may include them as a standard package, or some vendors may not carry all the items.

PAC-P120W-FSP 120W AC/DC adapter kit



1.5.2. Configure-to-Order Service

Make the computer more tailored to your needs by selecting one or more components from the list below to be fabricated to the computer.

SSD-25032	Memoright 2.5" 32GB SATAII SSD kit	
MM-3CL-2G	DDR3L-1600 2GB SDRAM	
MM-3CL-4G	DDR3L-1600 4GB SDRAM	
MM-3CL-8G	DDR3L-1600 8GB SDRAM	
WiFi-AT2350	Atheros AR9462 WiFi module w/ 20cm & 30cm internal wiring	
ANT-D11	1 x WiFi Dual-band 2.4G/5G antenna	

This page is intentionally left blank.

Chapter 2

Getting Started

2.1. Dimensions

The following illustration shows the dimensions of the computer, with the measurements in width, depth, and height called out.

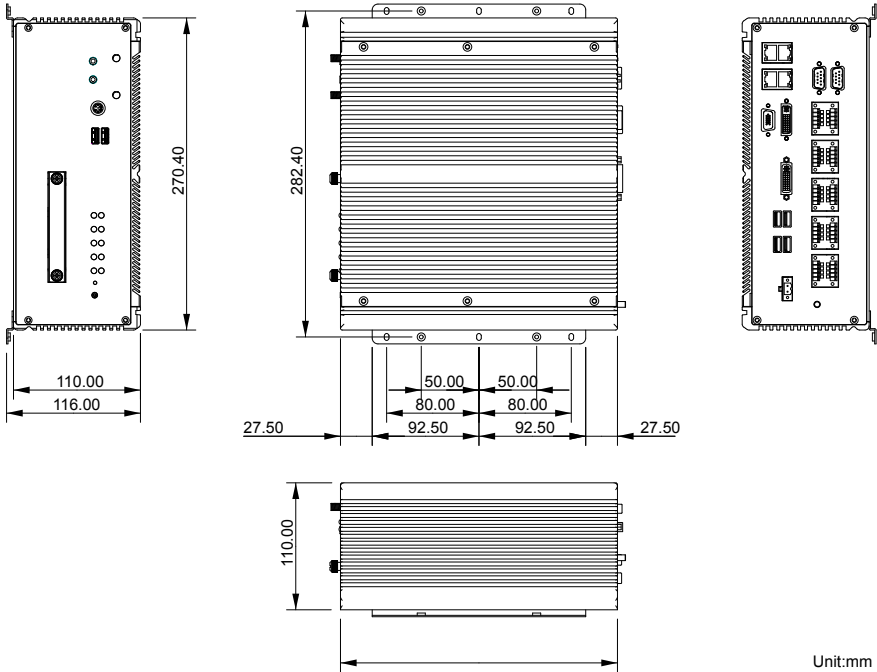

2.2. Take A Tour

The computer has some I/O ports, status LED light and controls on the front and rear panel. The following illustrations show all the components called out .

Front View

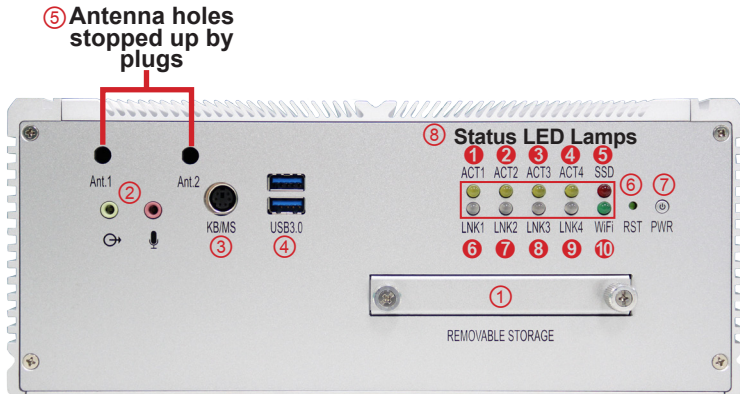

- I/O

No.	Description	No.	Description
①	SSD tray 1	⑤	Antenna holes stopped up by plugs
②	Line-out (Green) / Mic-in (Pink)	⑥	Reset button (accessible with a pin)
③	PS/2 KB/MS port	⑦	Power button
④	USB 3.0 port	⑧	LED indicator

- Status LED Lamps:

No.	LED Color	Description
①	Green	This LED lights green when LAN1 port is connected to 100M bit/s network equipment.
	Orange	This LED lights orange when LAN1 port is connected to 1000M bit/s network equipment.
②	Green	This LED lights green when LAN2 port is connected to 100M bit/s network equipment.
	Orange	This LED lights orange when LAN2 port is connected to 1000M bit/s network equipment.

3	Green	This LED lights green when LAN3 port is connected to 100M bit/s network equipment.
	Orange	This LED lights orange when LAN3 port is connected to 1000M bit/s network equipment.
4	Green	This LED lights green when LAN4 port is connected to 100M bit/s network equipment.
	Orange	This LED lights orange when LAN4 port is connected to 1000M bit/s network equipment.
5	Red	This LED lights red when SSD is being accessed.
6	Yellow	This LED lights yellow when LAN1 port is streaming data.
7	Yellow	This LED lights yellow when LAN2 port is streaming data.
8	Yellow	This LED lights yellow when LAN3 port is streaming data.
9	Yellow	This LED lights yellow when LAN4 port is streaming data.
10	Green	This LED lights green when WiFi is On.

Rear View

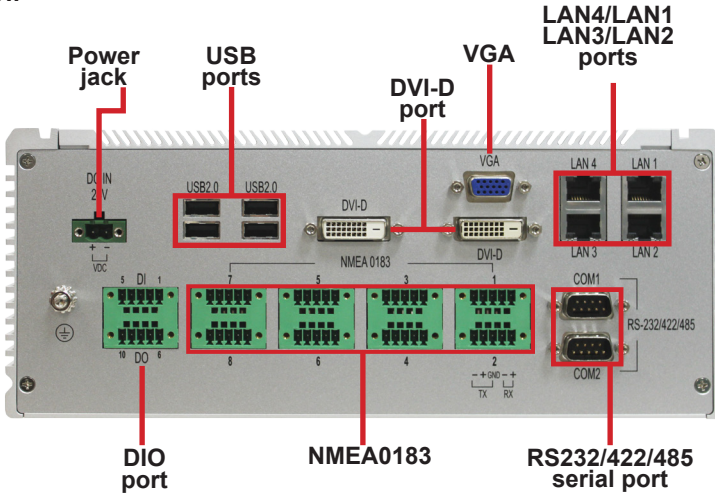

2.3. Driver Installation Notes

The computer supports the operating systems of Windows 7. Find the necessary device drivers on the CD that comes with your purchase. DO follow the sequence below to install the drivers to prevent errors:

Chipset→VGA→Audio→Ethernet→ME

Paths to find device drivers on CD:

Windows 7	
Device	Driver Path
Chipset	\\Chipset\ (infirst_autol_V9.4.0.1026.exe)
VGA	32bit: \\VGA\32Bit\ (Win32_15338.exe)
	64bit: \\VGA\64Bit\ (Win64_15338.exe)
Audio	32bit: \\Audio\Win7_8_Vista\ (32bit_Win7_Win8_Win81_R273.exe)
	64bit: \\Audio\Win7_8_Vista\ (64bit_Win7_Win8_Win81_R273.exe)
Ethernet	32bit: \\Ethernet\Win7-32bit\ (PROWin32.exe)
	64bit: \\Ethernet\Win7-64bit\ (PROWinx64.exe)
Intel® Management Engine	\\ME\ (Setup.exe)
USB3.0	\\USB3.0\Win7\ (Setup.exe)

Windows 8.1	
Device	Driver Path
Chipset	\\Chipset\ (infirst_autol_V9.4.0.1026.exe)
VGA	32Bit : \\VGA\32Bit\ (Win32_15338.exe)
	64Bit: \\VGA\64Bit\ (Win64_15338.exe)
Audio	32Bit : \\Audio\Win7_8_Vista\ (32bit_Win7_Win8_Win81_R273.exe)
	64Bit: \\Audio\Win7_8_Vista\ (64bit_Win7_Win8_Win81_R273.exe)
Ethernet	32Bit : \\Ethernet\Win81-32bit\ (PROWin32.exe)
	64Bit: \\Ethernet\Win81-64bit\ (PROWinx64.exe)
Intel® Management Engine	\\ME\ (Setup.exe)
USB3.0	\\USB3.0\ (Setup.exe)

This page is intentionally left blank.

Chapter 3

System Configuration

3.1. Board Layout

The engine of the computer is constructed by a CPU board and a carrier board. Following in this section you will be guided through the CPU boards and carrier board of the computers.

3.1.1. CPU Boards

The CPU board for ARTS-2870 is EmETXe-i87M0-i5-4402E.

The CPU board for ARTS-2870 is EmETXe-i87M0-i5-4402E, with Intel® Core™ i5-4402E.

Top View

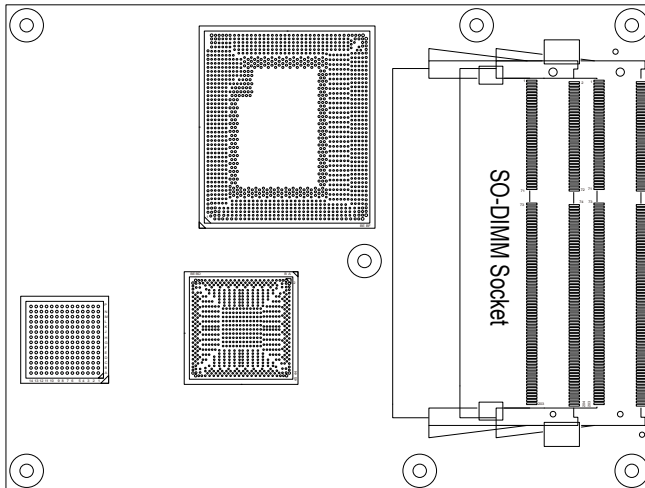

Bottom View

COM Express® AB Connector
COM Express® CD Connector

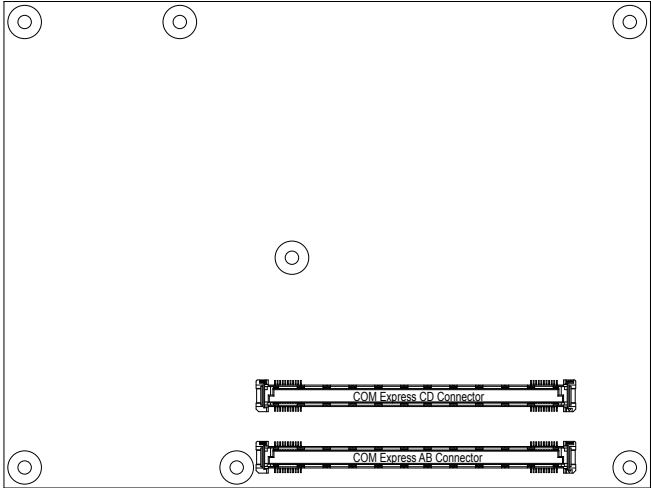

3.1.2. Carrier Board

PBC-1917 is the carrier board.

PBC-1917: Board Top

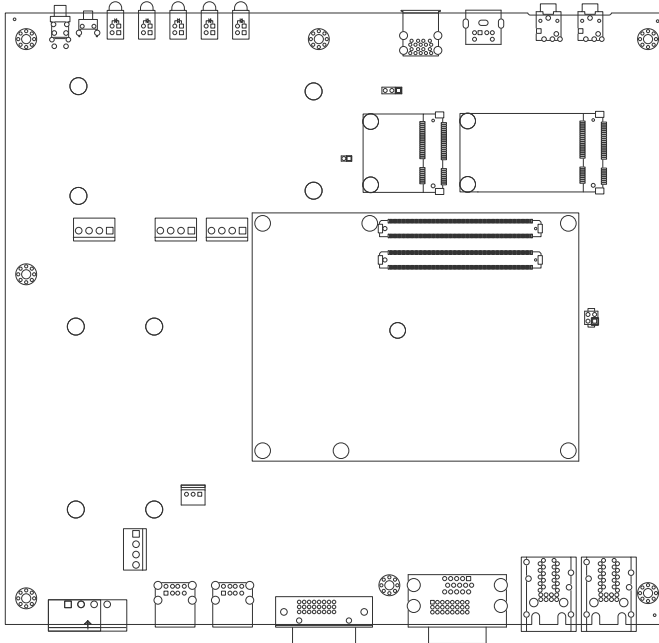

PBC-1917: Board Bottom

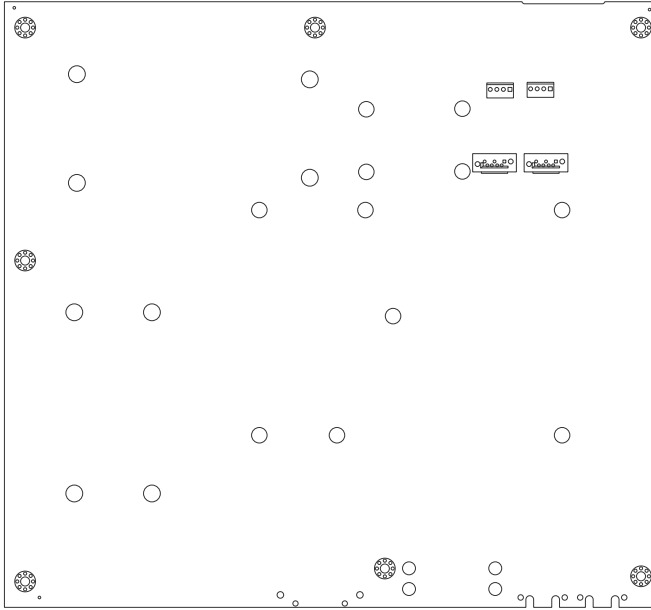

SCBD-147U: Board Top

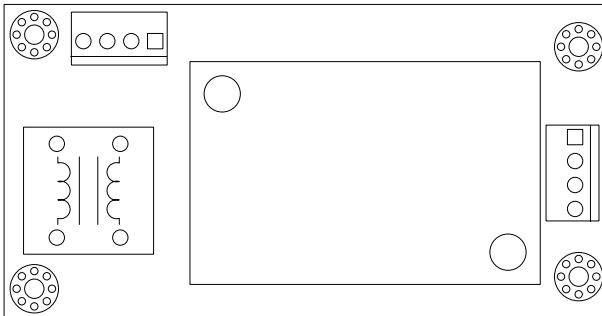

3.2. Jumpers and Connectors

The carrier board PBC-1917 comes with some connectors to join devices and some jumpers to alter the computer's hardware configuration. The following in this chapter will explicate each of these components.

3.2.1. Jumpers

JRTC1

Function: CMOS Setting

Jumper Type: Onboard 2.54mm-pitch 1x3-pin header



Setting: Short pin 1 and pin 2 to keep CMOS.
(The default setting.)



Short pin 2 and pin 3 to clear CMOS.



Board Top

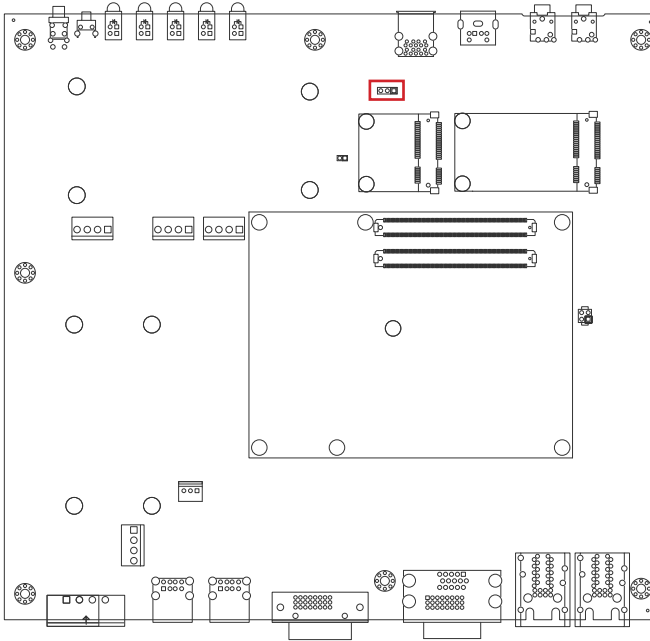

3.2.2. Connectors

JPH2

Function: Power/Reset pin-header

Connector Type: Onboard 2.54mm-pitch 2x2-pin header



Pin	Description
1	SYS_RESET#
2	GND
3	PIC_PWSIN#
4	GND

Board Top

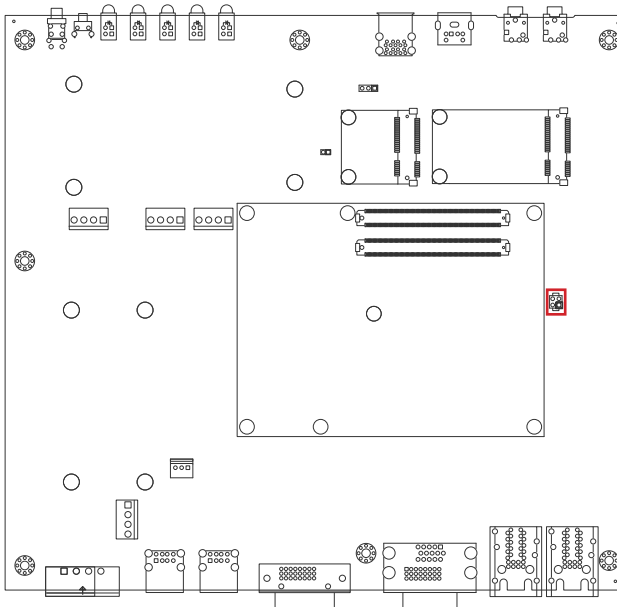

JVOUT1

Description: Power connector

Connector Type: Onboard 3.96mm-pitch 4-pin wafer connector

Pin	Description
1	ADPIN
2	ADPIN
3	ADP-GND
4	ADP-GND

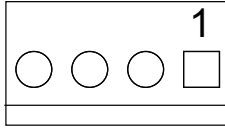

Board Top

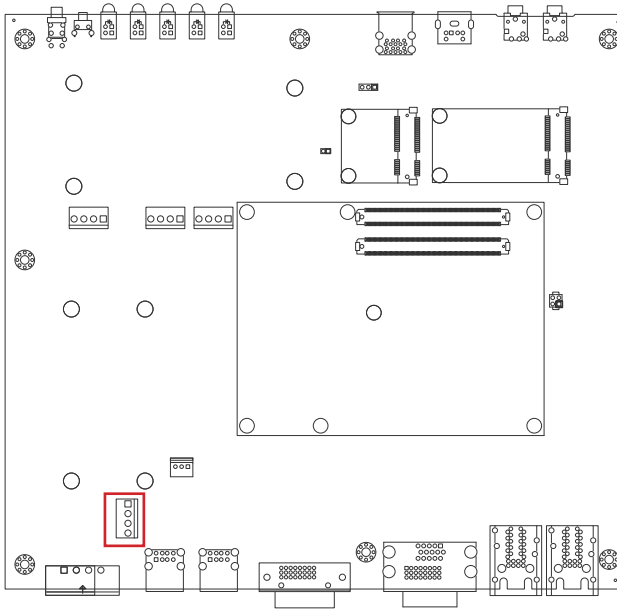

JVOUT2

Description: Power connector

Connector Type: Onboard 3.96mm-pitch 4-pin wafer connector

Pin	Description
1	DCIN_VCC
2	DCIN_VCC
3	P-GND
4	P-GND

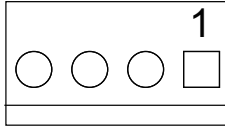

Board Top

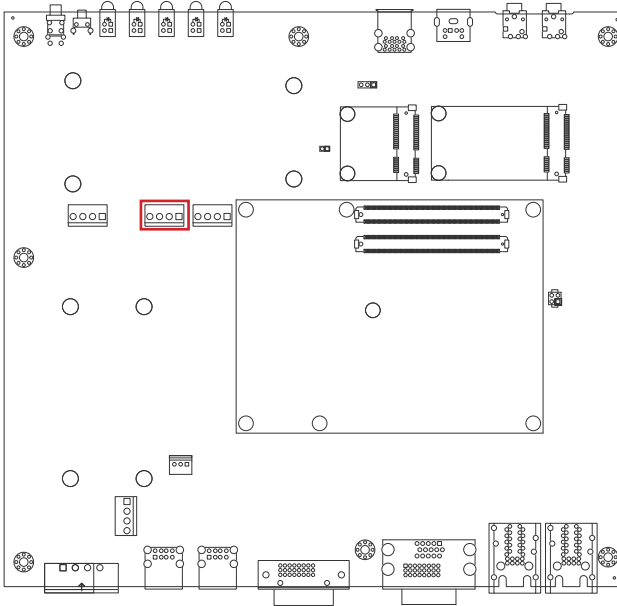

JPWRIN2

Description: Power connector

Connector Type: Onboard 3.96mm-pitch 4-pin wafer connector

Pin	Description
1	DCIN
2	DCIN
3	P-GND
4	P-GND

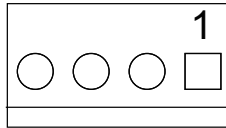

Board Top

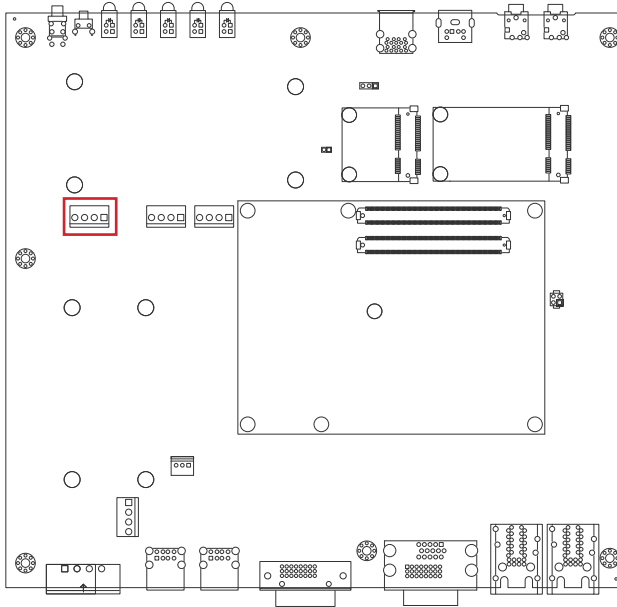

JPWRIN3

Description: Power connector

Connector Type: Onboard 3.96mm-pitch 4-pin wafer connector

Pin	Description
1	12VSB
2	12VSB
3	GND
4	GND

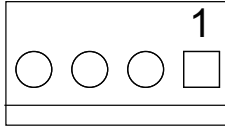

Board Top

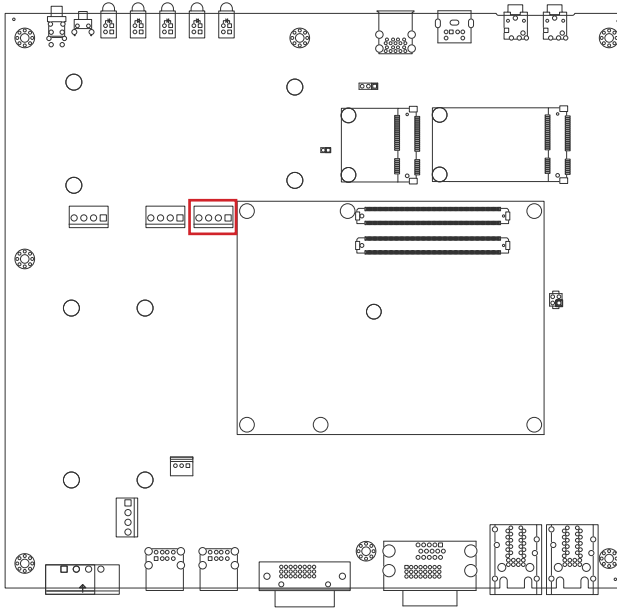

SATA1 & SATA2

Description: Serial ATA connectors for storage devices

Connector Type: 7-pin serial ATA connector

Pin	Description
1	GND
2	TX+
3	TX-
4	GND
5	RX-
6	RX+
7	GND

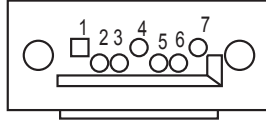

Board Bottom

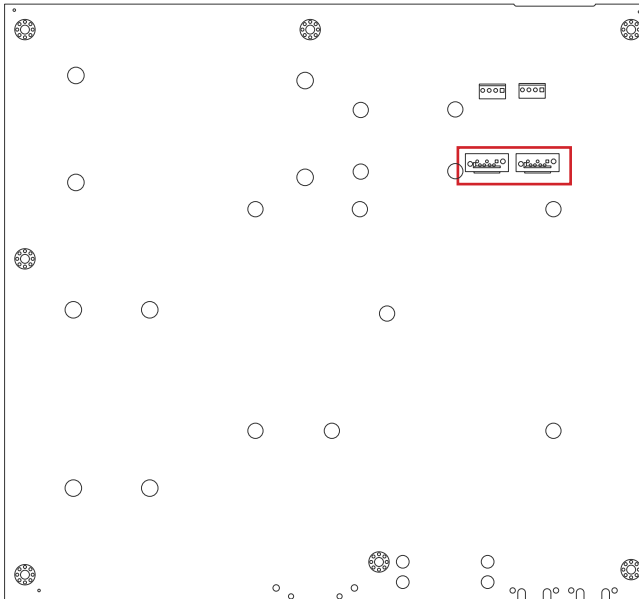

JSPWR1 & JSPWR2

Description: SATA1 And SATA2 Power connector

Connector Type: Onboard 3.96mm-pitch 4-pin wafer connector

Pin	Description
1	VCC5
2	GND
3	GND
4	VCC12

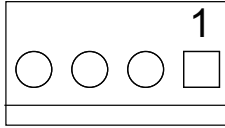

Board Bottom

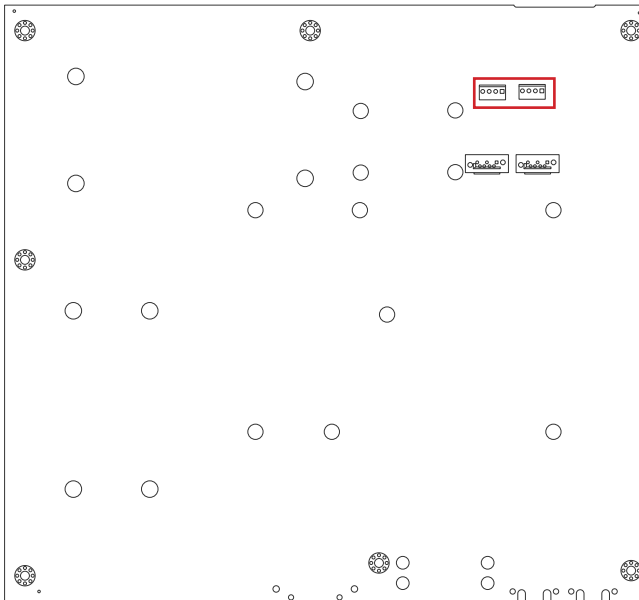

MC1

Description: PCI Express Mini-card socket

Connector Type: Onboard 0.8mm-pitch 52-pin edge card connector

The pin assignments conform to the industry standard.

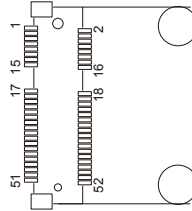

Board Top

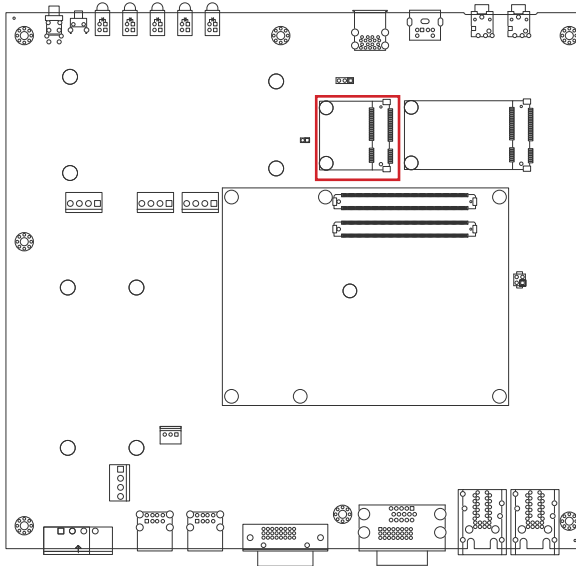

MSATA1

Description: mSATA socket

Connector Type: Onboard 0.8mm pitch 52-pin edge card connector

The pin assignments conform to the industry standard.



Board Top

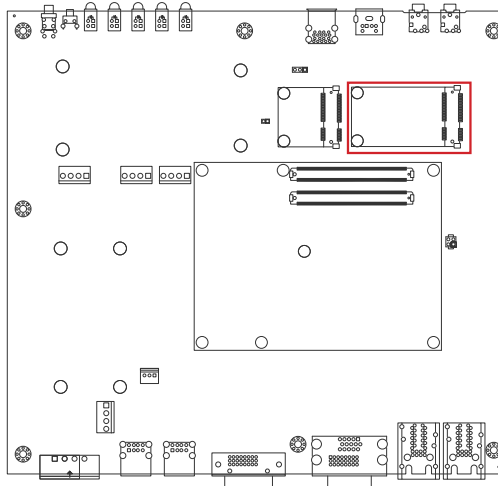

CN8

Function: Double-stacked USB 2.0/3.0 ports

Connector Type: USB 2.0/3.0 Type-A connectors

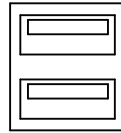

The pin assignments conform to the industry standard.

Board Top

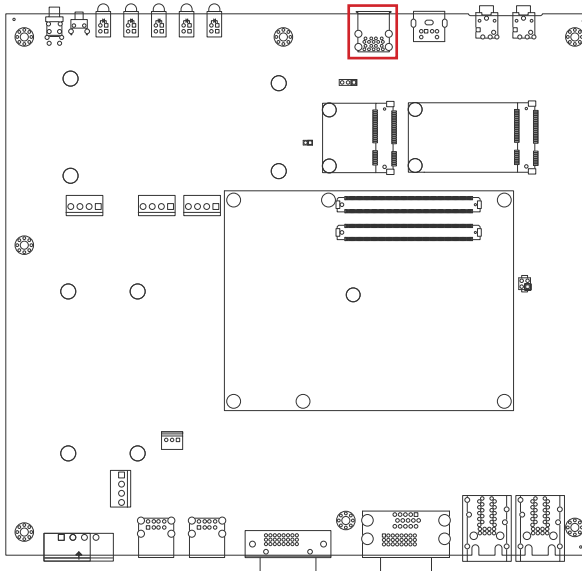

JKM1

Function: Keyboard/Mouse PS/2 Port

Connector Type: 6-pin Mini-DIN

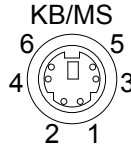

The pin assignments conform to the industry standard.

Board Top

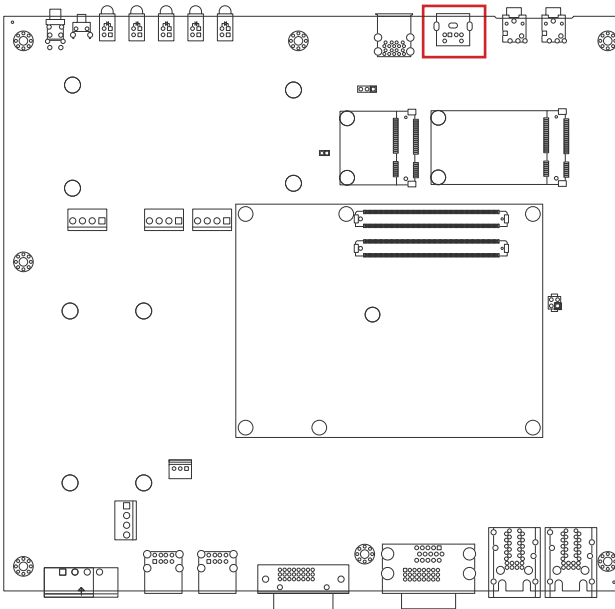

MIC1

Description: Mic-in Port

Connector Type: Pink 3.5mm audio jack



Front Panel

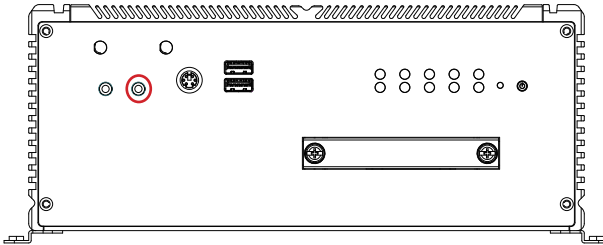

JLOUT11

Description: Line-out Port

Connector Type: Green 3.5mm audio jack



Front Panel

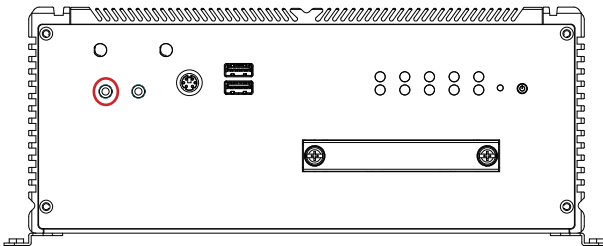

CN4 & CN5

Function: 2 x Ethernet 10/100/1000 Mbps Connectors

Connector type: RJ-45 stacked connector with LED

Pin	Description	Pin	Description
1	MDI0+	5	MDI2+
2	MDI0-	6	MDI2-
3	MDI1+	7	MDI3+
4	MDI10-	8	MDI3-

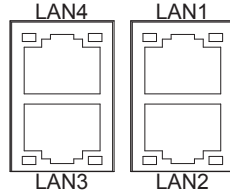

Board Top

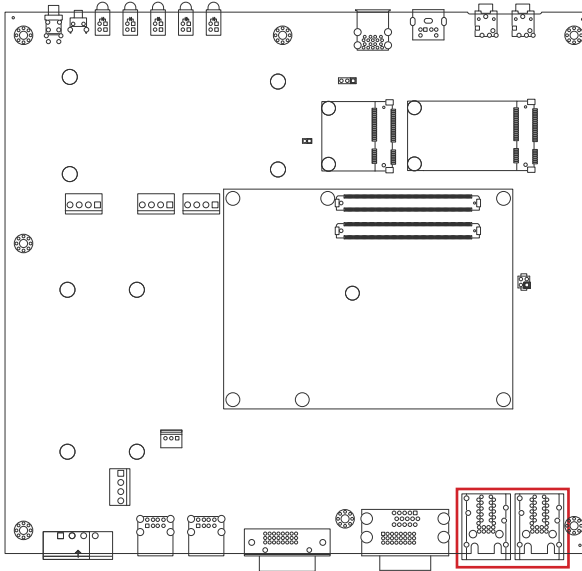

CN3

Function: Analog RGB & DVI-D Connector

Connector type: Analog RGB (D-Sub 15-pin female type) + DVI-D (DVI-D female connector)



Analog RGB Connector

The pin assignments conform to the industry standard.

DVI-D Connector

The pin assignments conform to the industry standard.

Board Top

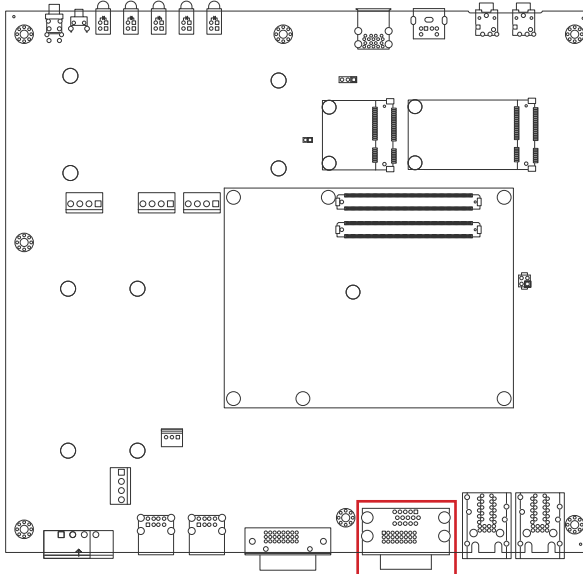

CN3

Function: DVI-D Connector

Connector type: DVI-D (DVI-D female connector)

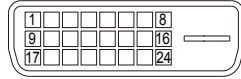

The pin assignments conform to the industry standard.

Board Top

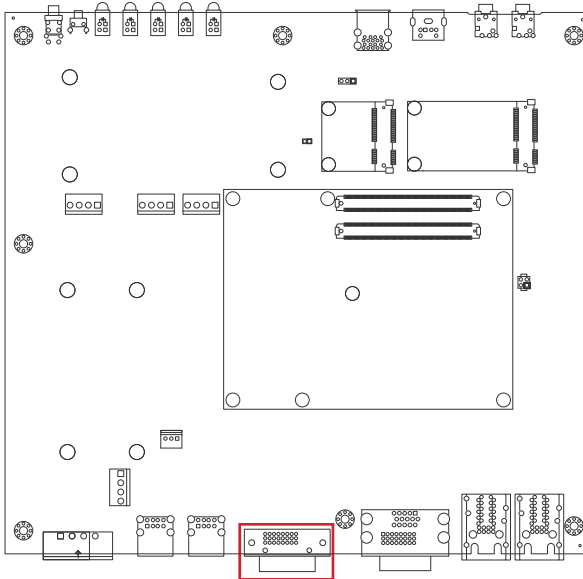

CN6 & CN7

Function: Double-stacked USB ports

Connector Type: USB 2.0 Type-A connectors

The pin assignments conform to the industry standard.

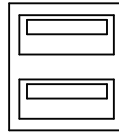

Board Top

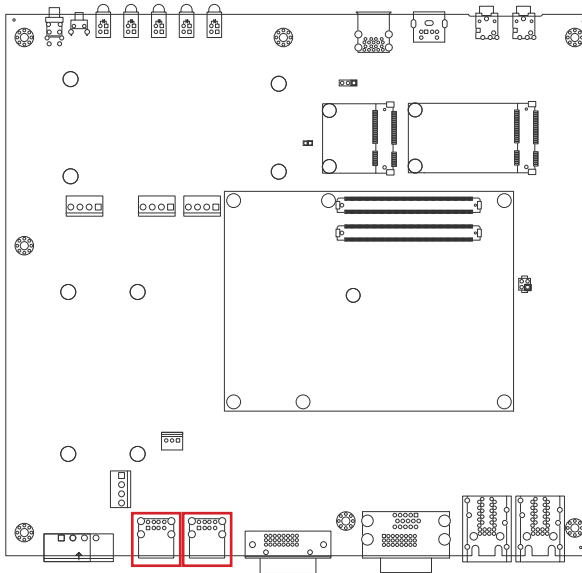

JPWRIN4

Function: Power Input Connector

Connector Type: 5.0mm pitch 2-pin terminal block

Pin	Description
1	ADPIN 24V
2	ADP-GND

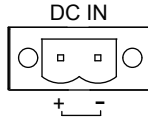

Board Top

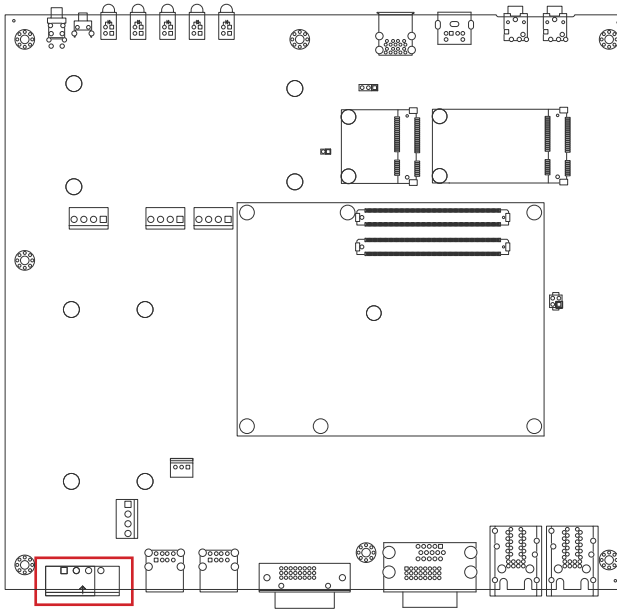

System Configuration

CN1

Function: Double-stacked RS-232/422/485 COM Port for COM1 (A) & COM2 (B)

Connector Type: External 9-pin D-sub male connector

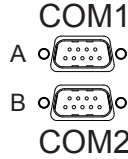

COM1 RS232 Mode			COM2 RS232 Mode		
Pin	Description	Pin Description	Pin	Description	Pin Description
A1	DCD1#	A2 RXD1	B1	DCD2#	B2 RXD2
A3	TXD1	A4 DTR1#	B3	TXD2	B4 DTR2#
A5	GND	A6 DSR1#	B5	GND	B6 DSR2#
A7	RTS1#	A8 CTS1#	B7	RTS2#	B8 CTS2#
A9	RI1#		B9	RI2#	

COM1 RS422/485 Mode			COM2 RS422/485 Mode		
Pin	Description	Pin Description	Pin	Description	Pin Description
A1	RS422_TX- RS485_A or D-	A2 RS422_TX+ RS485_B or D+	B1	RS422_TX- RS485_A or D-	B2 RS422_TX+ RS485_B or D+
A3	RS422_RX+	A4 RS422_RX-	B3	RS422_RX+	B4 RS422_RX-
A5	GND	A6 N/C	B5	GND	B6 N/C

Rear Panel

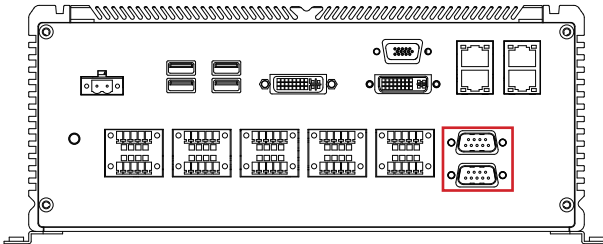

CN2

Description: NMEA0183 connector for COM3 (A) & COM4 (B)

Connector Type:

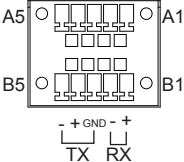

Pin	Description	Pin	Description
A1	RX+	B1	RX+
A2	RX-	B2	RX-
A3	GND	B3	GND
A4	TX+	B4	TX+
A5	TX-	B5	TX-

Rear Panel

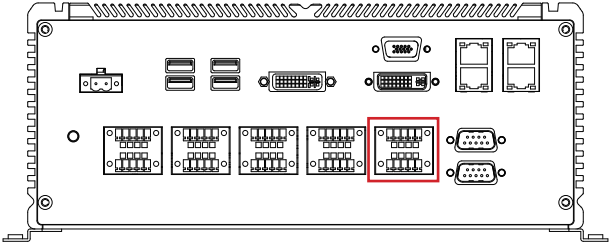

CN3

Description: NMEA0183 connector for COM5 (A) & COM6 (B)

Connector Type:

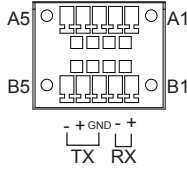

Pin	Description	Pin	Description
A1	RX+	B1	RX+
A2	RX-	B2	RX-
A3	GND	B3	GND
A5	TX+	B4	TX+
A5	TX-	B5	TX-

Rear Panel

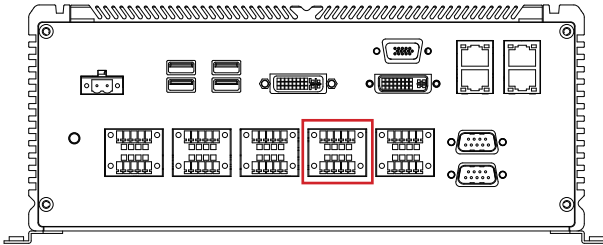

CN4

Description: NMEA0183 connector for COM7 (A) & COM8 (B)

Connector Type: 5x2 Terminal block

Pin	Description	Pin	Description
A1	RX+	B1	RX+
A2	RX-	B2	RX-
A3	GND	B3	GND
A5	TX+	B4	TX+
A5	TX-	B5	TX-

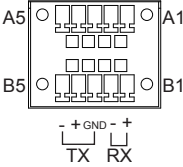

Rear Panel

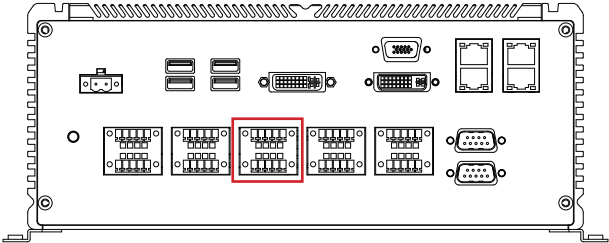

CN5

Description: NMEA0183 connector for COM9 (A) & COM10 (B)

Connector Type: 5x2 Terminal block

Pin	Description	Pin	Description
A1	RX+	B1	RX+
A2	RX-	B2	RX-
A3	GND	B3	GND
A5	TX+	B4	TX+
A5	TX-	B5	TX-

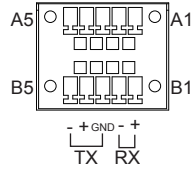

Rear Panel

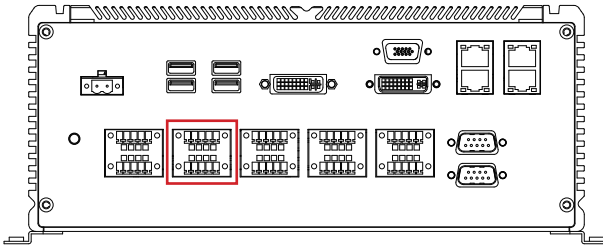

JDIO1

Description: DIGITAL SINGAL INPUT AND OUTPUT

Connector Type: 5x2 Terminal block (4-in, 4-out)

Pin	Description	Pin	Description
1	DIO_IN1	6	DIO_OUT1
2	DIO_IN2	7	DIO_OUT2
3	DIO_IN3	8	DIO_OUT3
4	DIO_IN4	9	DIO_OUT4
5	GND	10	GND

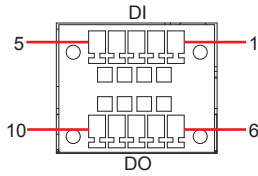

Rear Panel

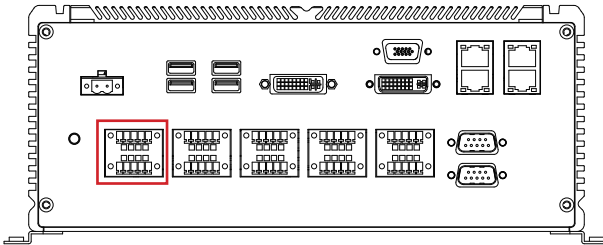

SCBD-147U:

JVIN3

Description: Power connector

Connector Type: Onboard 3.96mm-pitch 4-pin wafer connector

Pin	Description
1	DCIN_VCC
2	DCIN_VCC
3	P-GND
4	P-GND

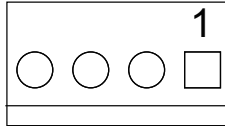

Board Top

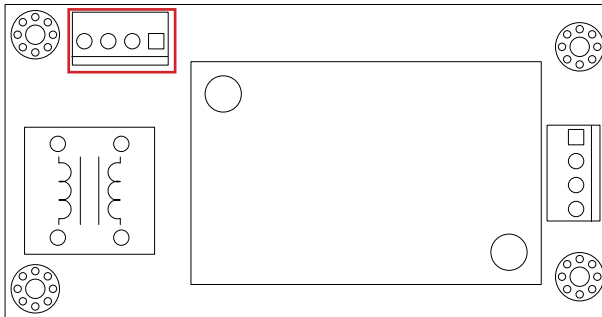

JPWRIN3

Description: Power connector

Connector Type: Onboard 3.96mm-pitch 4-pin wafer connector

Pin	Description
1	12VSB
2	12VSB
3	GND
4	GND

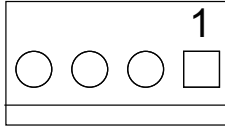

Board Top

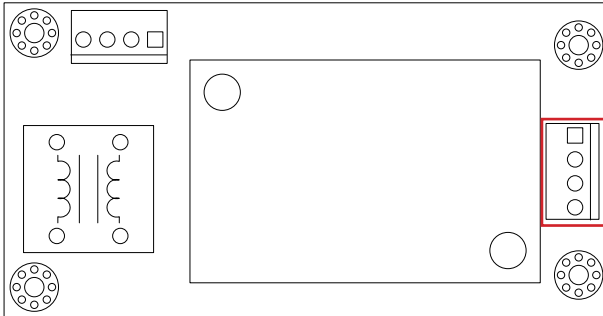

This page is intentionally left blank.

Chapter 4

Installation and Maintenance

4.1. Install Hardware

The computer is constructed based on modular design to make it easy for users to add hardware or to maintain the computer. The following sections will guide you to the simple hardware installations for the computer.

4.1.1. Open the Computer

All jumpers, connectors, and PCI Express Mini-card sockets are built on the carrier board. To access these components, the computer's top cover has to go. Follow through the steps below to remove the top cover from the computer.

1. Place the computer on a flat surface. Loosen and remove the 6 screws from the top cover as marked in the illustration below.



2. Dismount the top cover.

The inside of the computer comes to view.

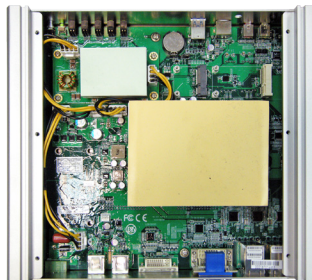

- ▶ To adjust jumpers or connect/disconnect devices to/from the carrier board, see [3.2.1. Jumpers](#) on page [18](#) and [3.2.2. Connectors](#) on page [19](#).

4.1.2. Install SATA SSD

The ARTS-2870 supports two 2.5-inch SSD storage devices. To install a 2.5" SSD to the computer, follow through the guide below:

1. On the front panel of the computer, find the two drawer-like brackets, each has two screws to fix it.



2. Loosen the screws and pull out the bracket.

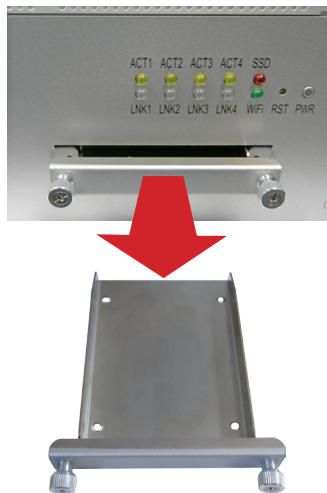

- Slide a 2.5-inch SSD into the bracket.



- Fix the assemblage with four flush head screws.

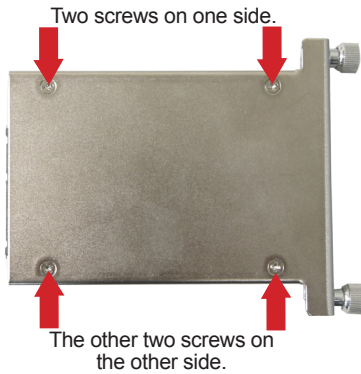

- Plug the bracket (with the SSD) back to the computer, and fasten screws.

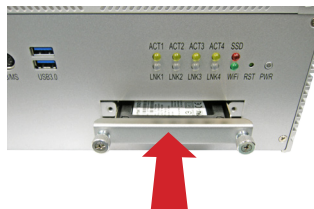

4.1.3. Install Memory Module on CPU Module

1. Open the computer as [4.1.1. Open the Computer](#)
2. Loose the 6 screws on the heat sink and remove the heat sink. Caution: Screws are under the heat spreading gel. Remove the spreading gel to unfasten the screws.

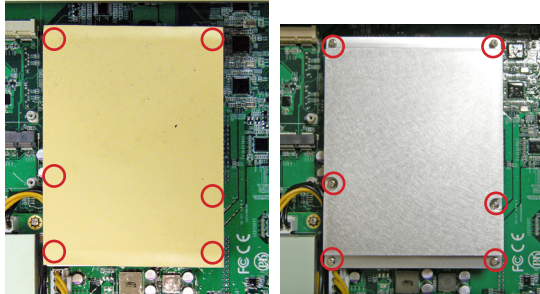

3. Locate the Memory module slot and insert the memory module.

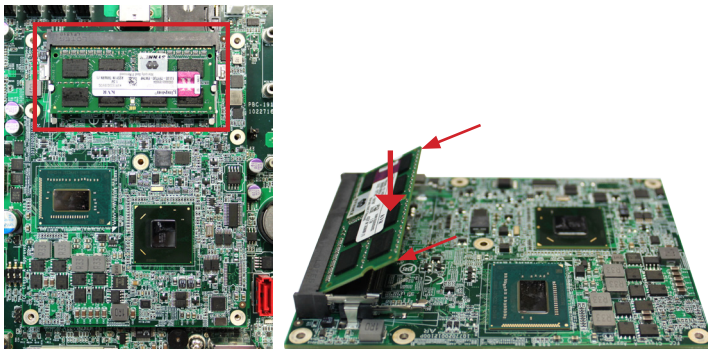

4. Put the heat sink back and fix it by fastening the 6 screws.
5. Assemble the Top cover.

4.2. Mount the Computer

Integrate the computer to where it works by mounting it to a wall in the surroundings. Such integration relies on a wall-mount kit, which comes with the computer. Follow through the guide below to assemble the kit to the computer:

1. Place the computer on a flat surface, with the bottom facing up. Find the screw holes at its bottom as marked in the red circles in the illustration below:

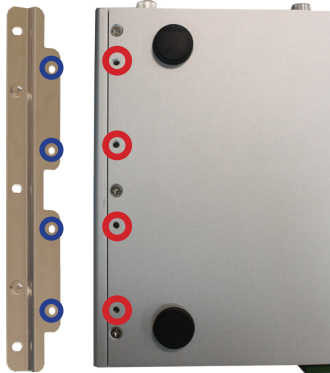

2. Have the two wall-mount brackets. Use the screws included in the wall-mount kit to assemble the brackets to the computer's bottom. (See the illustration above).



3. Use the other screw holes and cutouts on both wall-mount brackets to mount the computer to a wall. (See the green circles in the illustration below).



4.3. Wire DC-in Power Source

 **Warning** Only trained and qualified personnel are allowed to install or replace this equipment.

Follow the instructions below for connecting the computer to a DC-input power source.

DC power Input wiring pin definition is as follow,

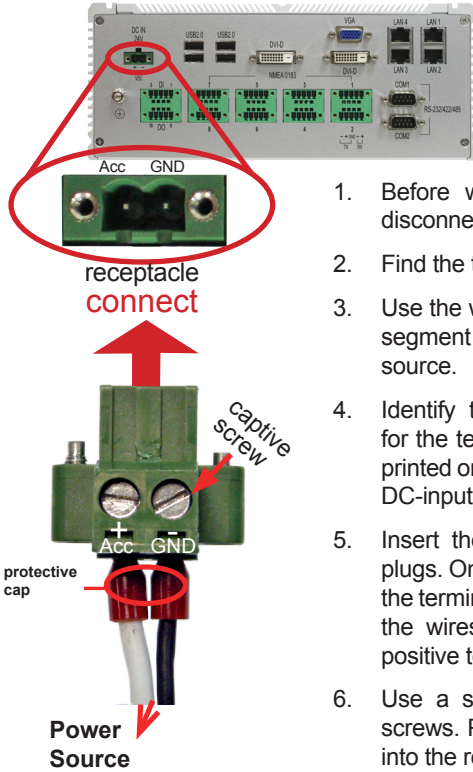

1. Before wiring, make sure the power source is disconnected.
2. Find the terminal block in the accessory box.
3. Use the wire-stripping tool to strip a short insulation segment from the output wires of the DC power source.
4. Identify the positive and negative feed positions for the terminal block connection. See the symbols printed on the rear panel indicating the polarities and DC-input power range in voltage.
5. Insert the exposed wires into the terminal block plugs. Only wires with insulation should extend from the terminal block plugs. Note the polarities between the wires and the terminal block plugs must be positive to positive and negative to negative.
6. Use a slotted screwdriver to tighten the captive screws. Plug the terminal block firmly, which wired, into the receptacle on the rear panel.

Chapter 5

BIOS

BIOS

The BIOS Setup utility for the computer is featured by American Megatrends Inc to configure the system settings stored in the system's BIOS ROM. The BIOS is activated once the computer powers on. When the computer is off, the battery on the main board supplies power to BIOS RAM.

To enter the BIOS Setup utility, keep hitting the "Delete" key upon powering on the computer.

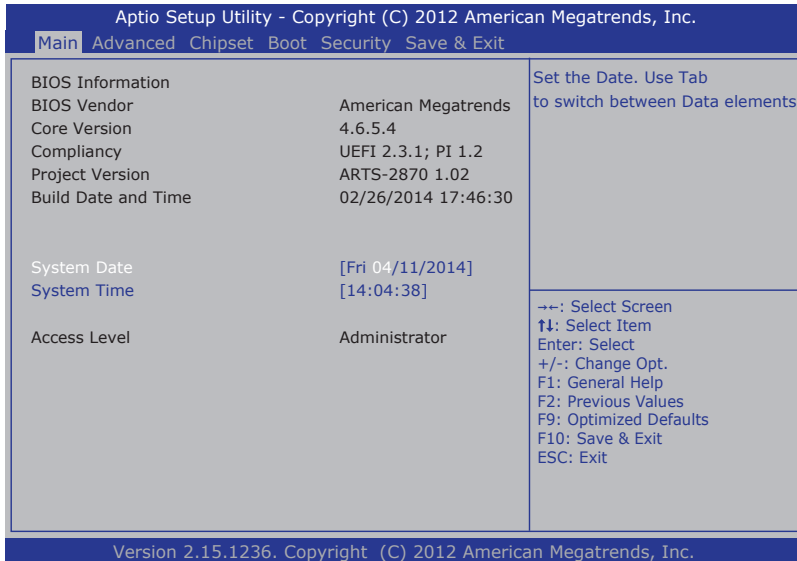

The BIOS Setup utility features the following menus:

Menu	Description
Main	See 5.1.1. Main on page 56 .
Advanced	See 5.1.2. Advanced on page 57 .
Chipset	See 5.1.3. Chipset on page 67 .
Boot	See 5.1.4. Boot on page 72
Security	See 5.1.5. Security on page 74
Save & Exit	See 5.1.6. Save & Exit on page 75

Key Commands

The BIOS Setup utility relies on a keyboard to receive user's instructions. Hit the following keys to navigate within the utility and configure the utility.

Keystroke	Function
← →	Moves left/right between the top menus.
↓ ↑	Moves up/down between highlight items.
Enter	Selects an highlighted item/field.
Esc	<ul style="list-style-type: none"> ▶ On the top menus: Use Esc to quit the utility without saving changes to CMOS. (The screen will prompt a message asking you to select OK or Cancel to exit discarding changes. ▶ On the submenus: Use Esc to quit current screen and return to the top menu.
Page Up / +	Increases current value to the next higher value or switches between available options.
Page Down / -	Decreases current value to the next lower value or switches between available options.
F1	Opens the Help of the BIOS Setup utility.
F10	Exits the utility saving the changes that have been made. (The screen then prompts a message asking you to select OK or Cancel to exit saving changes.)

Note: Pay attention to the "WARNING" that shows at the left pane onscreen when making any change to the BIOS settings.

This BIOS Setup utility is updated from time to time to improve system performance and hence the screenshots hereinafter may not fully comply with what you actually have onscreen.

5.1. BIOS

This section will guide you to the BIOS Setup utility .

5.1.1. Main

The **Main** menu features the settings of **System Date** and **System Time** and also displays some BIOS info and system info.

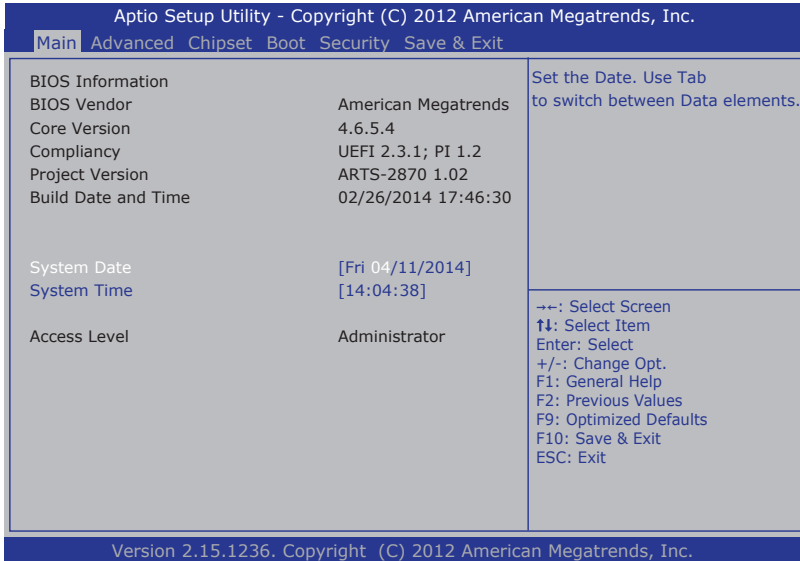

The BIOS info displayed are:

Group	Info	Description
BIOS Information	BIOS Vendor	Delivers the provider of this BIOS Setup utility.
	Core Version	Delivers the version of the core.
	Compliancy	Delivers the UEFI support.
	Project Version	Delivers the version of Project
	BIOS Version	Delivers the system's BIOS version.
	Build Date and Time	Delivers the date and time while the BIOS Setup utility was created/updated.
Access Level	Delivers the level that the BIOS is being accessed at the moment. (Only Administrator Level is available.)	

The featured settings are:

Setting	Description
System Time	Sets system time.
System Date	Sets system date.

5.1.2. Advanced

Access the **Advanced** menu to manage the computer’s system configuration including the Super IO chip.

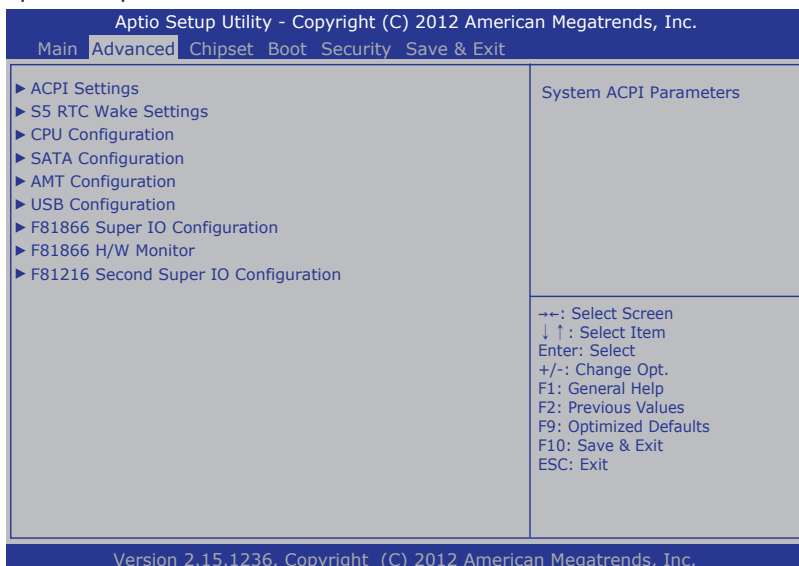

The featured settings and submenus are:

Setting	Description
ACPI Settings	See 5.1.2.1. ACPI Settings on page 58.
S5 RTC Wake Settings	See 5.1.2.2. S5 RTC Wake Settings on page 58.
CPU Configuration	See 5.1.2.3. CPU Configuration on page 59.
SATA Configuration	See 5.1.2.4. SATA Configuration on page 60.
AMT Configuration	See 5.1.2.5. AMT Configuration on page 61.
USB Configuration	See 5.1.2.6. USB Configuration on page 63.
F81866 Super IO Configuration	See 5.1.2.7. F71869E Super IO Configuration on page 64.
F81866 H/W Monitor	See 5.1.2.8. F81866 H/W Monitor on page 65.
F81216 Second Super IO Configuration	See 5.1.2.10. F81216 Second Super IO Configuration on page 66.

5.1.2.1. ACPI Settings

Access this submenu to configure the system’s ACPI (Advanced Configuration and Power Interface). The featured settings are:

The featured settings are:

Setting	Description
Enable Hibernation	<p>Enables/disables the system to/from hibernation (OS/S4 Sleep State).</p> <ul style="list-style-type: none"> ▶ This option is fixed. ▶ Enabled is the default.
ACPI Sleep State	<p>Sets the highest ACPI Sleep State that system enters when the suspend button is hit.</p> <ul style="list-style-type: none"> ▶ This option is fixed. ▶ Suspend Disabled is the default.

5.1.2.2. S5 RTC Wake Settings

Access this submenu to enable/disable the system to wake up on a specified time.

The featured setting is:

Setting	Description								
Wake System with Fixed Time	<p>Sets if to awake the system at a defined moment.</p> <ul style="list-style-type: none"> ▶ Options available are Enabled and Disabled (default). ▶ Enable this feature to awake the system at a defined moment in time. When enabled, the following settings become available: 								
	<table border="1"> <thead> <tr> <th>Setting</th> <th>Description</th> </tr> </thead> <tbody> <tr> <td>Wake up hour</td> <td> <p>Defines the (hour) time to awake the system.</p> <ul style="list-style-type: none"> ▶ 0 to 23 configurable. </td> </tr> <tr> <td>Wake up minute</td> <td> <p>Defines the (minute) time to awake the system.</p> <ul style="list-style-type: none"> ▶ 0 to 59 configurable. </td> </tr> <tr> <td>Wake up second</td> <td> <p>Defines the (second) time to awake the system.</p> <ul style="list-style-type: none"> ▶ 0 to 59 configurable. </td> </tr> </tbody> </table>	Setting	Description	Wake up hour	<p>Defines the (hour) time to awake the system.</p> <ul style="list-style-type: none"> ▶ 0 to 23 configurable. 	Wake up minute	<p>Defines the (minute) time to awake the system.</p> <ul style="list-style-type: none"> ▶ 0 to 59 configurable. 	Wake up second	<p>Defines the (second) time to awake the system.</p> <ul style="list-style-type: none"> ▶ 0 to 59 configurable.
	Setting	Description							
	Wake up hour	<p>Defines the (hour) time to awake the system.</p> <ul style="list-style-type: none"> ▶ 0 to 23 configurable. 							
Wake up minute	<p>Defines the (minute) time to awake the system.</p> <ul style="list-style-type: none"> ▶ 0 to 59 configurable. 								
Wake up second	<p>Defines the (second) time to awake the system.</p> <ul style="list-style-type: none"> ▶ 0 to 59 configurable. 								
Wake up minute	<p>Defines the (minute) time to awake the system.</p> <ul style="list-style-type: none"> ▶ 0 to 59 configurable. 								
Wake up second	<p>Defines the (second) time to awake the system.</p> <ul style="list-style-type: none"> ▶ 0 to 59 configurable. 								
Wake System with Dynamic Time	<p>Sets if to awake the system some time in the future.</p> <ul style="list-style-type: none"> ▶ Options available are Enabled and Disabled (default). ▶ Enable this feature to awake the system some time from now. When enabled, the following setting becomes available: 								
	<table border="1"> <thead> <tr> <th>Setting</th> <th>Description</th> </tr> </thead> <tbody> <tr> <td>Wake up minute increase</td> <td> <p>Defines how long from now to awake the system.</p> <ul style="list-style-type: none"> ▶ 1 to 5 minutes configurable. </td> </tr> </tbody> </table>	Setting	Description	Wake up minute increase	<p>Defines how long from now to awake the system.</p> <ul style="list-style-type: none"> ▶ 1 to 5 minutes configurable. 				
Setting	Description								
Wake up minute increase	<p>Defines how long from now to awake the system.</p> <ul style="list-style-type: none"> ▶ 1 to 5 minutes configurable. 								

5.1.2.3. CPU Configuration

Select **CPU Configuration** to run a report of the CPU's details including the hardware version, software version, model name, processor speed, microcode revision, max./min. processor speeds, the amount of processor core(s), and CPU caches. See the depiction below:

The screenshot shows the Aptio Setup Utility interface. At the top, it says "Aptio Setup Utility - Copyright (C) 2012 American Megatrends, Inc." Below this is a navigation bar with tabs: "Main", "Advanced", "Chipset", "Boot", "Security", and "Save & Exit". The "Advanced" tab is selected. The main area is titled "CPU Configuration" and lists the following details:

- Intel(R) Core(TM) i5-4402E CPU @ 1.60GHz
- CPU Signature: 306c3
- Processor Family: 6
- Microcode Patch: 16
- FSB Speed: 100 MHz
- Max CPU Speed: 1600 MHz
- Min CPU Speed: 800 MHz
- CPU Speed: 2600 MHz
- Processor Cores: 2
- Intel HT Technology: Supported
- Intel VT-x Technology: Supported
- Intel SMX Technology: Supported
- 64-bit: Supported
- EIST Technology: Supported
- CPU C3 State: Supported
- CPU C6 State: Supported
- CPU C7 State: Supported
- L1 Data Cache: 32 kB x 2
- L1 Code Cache: 32 kB x 2
- L2 Cache: 256 kB x 2
- L3 Cache: 3072 kB

On the right side of the CPU Configuration menu, there is a legend for navigation:

- ++ : Select Screen
- ↓ ↑ : Select Item
- Enter: Select
- +/-: Change Opt.
- F1: General Help
- F2: Previous Values
- F9: Optimized Defaults
- F10: Save & Exit
- ESC: Exit

At the bottom of the screen, it says "Version 2.15.1236. Copyright (C) 2012 American Megatrends, Inc."

Use this submenu to enable/disable the CPU Turbo mode.

Submenu	Description
Turbo Mode	Enables/disables the CPU Turbo Mode. ▶ Enabled is the default.

5.1.2.4. SATA Configuration

SATA Configuration delivers SATA device(s) information and configures SATA device(s).

The featured settings are:

Setting	Description
SATA Controller(s)	Enables/disables SATA device(s). ▶ Enabled is the default.
SATA Mode Selection	Configures how SATA controller(s) operate. ▶ Options available are IDE (default), AHCI and RAID .
SATA Controller Speed	Configures Maximum Speed of SATA ▶ Options available are Default (default), Gen1 , Gen2 and Gen3 .
Serial ATA Port 0	Delivers the name and capacity of SATA device
Port 0	Enables/disables SATA port 0. ▶ Enabled is the default.
SATA Device Type	Configures the Device Type of SATA port 0. ▶ Options available are Hard Disk Drive (default), and Solid State Drive .
Serial ATA Port 1	Delivers the name and capacity of SATA device
Port 1	Enables/disables SATA port 1. ▶ Enabled is the default.
SATA Device Type	Configures the Device Type of SATA port 0. ▶ Options available are Hard Disk Drive (default), and Solid State Drive .
Serial ATA Port 2	Delivers the name and capacity of SATA device
Port 2	Enables/disables SATA port 2. ▶ Enabled is the default.
SATA Device Type	Configures the Device Type of SATA port 0. ▶ Options available are Hard Disk Drive (default), and Solid State Drive .

5.1.2.5. AMT Configuration

Intel® Active Management Technology (Intel® AMT) is a hardware-based solution that uses out-of-band communication for basic management of client systems, which allows a system administrator to monitor and manage the computers and other network equipment by remote control even if the hard drive is crashed, the system is turned off or the operating system is locked.

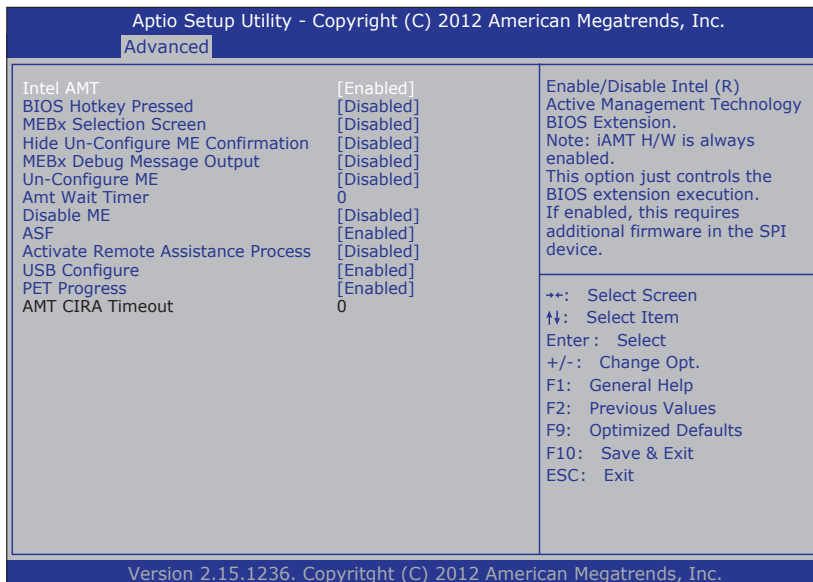

The featured settings are:

Setting	Description
Intel AMT	Enables/disables Intel® Active Management Technology BIOS extensions. ▶ Enabled is the default. Note. iAMT hardware is always enabled. This setting only controls BIOS extension execution. When enabled, additional firmware is required in the SPI device.
BIOS Hotkey Pressed	Enables/disables BIOS Hotkey Press function ▶ Disabled is the default.
MEBx Selection Screen	Enables/disables MEBx Selection Screen function. ▶ Disabled is the default.

Hide Un-Configure ME Confirmation	<p>Enables/disables Hide Un-Configure ME without password Configuration Prompt function.</p> <ul style="list-style-type: none"> ▶ Disabled is the default.
MEBx Debug Message Output	<p>Enables/disables MEBx Debug Message Output function.</p> <ul style="list-style-type: none"> ▶ Disabled is the default.
Un-Configure ME	<p>Enables/disables Un-Configure ME without password function.</p> <ul style="list-style-type: none"> ▶ Disabled is the default.
Amt Wait Timer	<p>Set time to wait before sending ASF_GET_BOOT_OPTIONS.</p>
Disable ME	<p>Set ME to soft Temporary Disabled function</p>
ASF	<p>Enables/disables Alert Specification Format, a DMTF (Distributed Management Task Force) standard for remote monitoring, management and control of computer system in both OS-present and OS-absent environments.</p> <ul style="list-style-type: none"> ▶ Enabled is the default.
Activate Remote Assistance Process	<p>Enables/disables CIRA (Client-Initiated Remote Access) boot.</p> <ul style="list-style-type: none"> ▶ Disabled is the default.
USB Configure	<p>Enables/disables USB Configure function.</p> <ul style="list-style-type: none"> ▶ Disabled is the default.
PET Progress	<p>Enables/disables PET events progress to receive PET event or not.</p>
AMT CIRA Timeout	<p>Customizes the time-out for the establishment of MPS connection.</p> <ul style="list-style-type: none"> ▶ This setting is only available when Activate Remote Assistance Process is enabled. ▶ Set it to 0 to use the default time-out value of 60 seconds. ▶ Set it to 255 to have MEBx wait until the connection succeeds. ▶ CIRA means “Client Initiated Remote Access”.

5.1.2.6. USB Configuration

Access this submenu to view the USB device(s) enabled in the system. It also configures USB-related features.

The featured settings are:

Setting	Description / Available Options								
Legacy USB Support	Enables/disables legacy USB support including USB flash drives and USB hard drives. Options available are <ul style="list-style-type: none"> ▶ Enabled: To enable legacy USB support. ▶ Disabled: To keep USB devices available only for EFI specification, ▶ Auto: To disable legacy support if no USB devices are connected. 								
USB3.0 Support	Enables/disables USB 3.0 controller support. ▶ Enabled is the default.								
XHCI Hand-off	This is a workaround for OSeS without XHCI hand-off support. The XHCI ownership change should be claimed by XHCI driver. The optional settings are: Enabled / Disabled .								
EHCI Hand-off	This is a workaround for OSeS without EHCI hand-off support. The EHCI ownership change should be claimed by EHCI driver. The optional settings are: Disabled / Enabled .								
USB Mass Storage Driver Support	Enables/disables USB Mass Storage Driver Support. The optional settings are: Disabled / Enabled .								
USB hardware delay and time-out	This is a submenu to configure the features of USB hardware delay and time-out. The featured settings are:								
	<table border="1"> <thead> <tr> <th>Setting</th> <th>Description</th> </tr> </thead> <tbody> <tr> <td>USB Transfer time-out</td> <td>Use this item to set the time-out value for control, bulk, and interrupt transfers. ▶ Options available are: 1 sec, 5 sec, 10 sec, 20 sec</td> </tr> <tr> <td>Device reset time-out</td> <td>Use this item to set USB mass storage device start unit command time-out. ▶ Options available are: 10 sec, 20 sec, 30 sec, 40 sec</td> </tr> <tr> <td>Device power-up delay</td> <td>Use this item to set maximum time the device will take before it properly reports itself to the host controller. 'Auto' uses default value: for a root port it is 100 ms, for a hub port the delay is taken from hub descriptor. ▶ Options available are: Auto: Default Manual: Select Manual you can set value for the following sub-item: 'Device Power-up delay in seconds', the delay range in from 1 to 40 seconds, in one second increments.</td> </tr> </tbody> </table>	Setting	Description	USB Transfer time-out	Use this item to set the time-out value for control, bulk, and interrupt transfers. ▶ Options available are: 1 sec, 5 sec, 10 sec, 20 sec	Device reset time-out	Use this item to set USB mass storage device start unit command time-out. ▶ Options available are: 10 sec, 20 sec, 30 sec, 40 sec	Device power-up delay	Use this item to set maximum time the device will take before it properly reports itself to the host controller. 'Auto' uses default value: for a root port it is 100 ms, for a hub port the delay is taken from hub descriptor. ▶ Options available are: Auto: Default Manual: Select Manual you can set value for the following sub-item: 'Device Power-up delay in seconds', the delay range in from 1 to 40 seconds, in one second increments.
	Setting	Description							
	USB Transfer time-out	Use this item to set the time-out value for control, bulk, and interrupt transfers. ▶ Options available are: 1 sec, 5 sec, 10 sec, 20 sec							
Device reset time-out	Use this item to set USB mass storage device start unit command time-out. ▶ Options available are: 10 sec, 20 sec, 30 sec, 40 sec								
Device power-up delay	Use this item to set maximum time the device will take before it properly reports itself to the host controller. 'Auto' uses default value: for a root port it is 100 ms, for a hub port the delay is taken from hub descriptor. ▶ Options available are: Auto: Default Manual: Select Manual you can set value for the following sub-item: 'Device Power-up delay in seconds', the delay range in from 1 to 40 seconds, in one second increments.								

5.1.2.7. F71869E Super IO Configuration

This submenu opens in context with the system's serial ports, COM1 and COM2, to configure the Super IO chipset.

The featured settings are:

Submenu/Setting	Description	
Serial Port 1 Configuration	Configures the system's serial port (COM port). The featured settings are:	
	Setting	Description
	Serial Port	Enables/disables the serial port. ▶ Enabled is the default.
Serial Port 1	▶ Options available are: RS232 Support / RS422 Support / RS485 Support	
Serial Port 2 Configuration	Configures the system's serial port (COM port). The featured settings are:	
	Setting	Description
	Serial Port	Enables/disables the serial port. ▶ Enabled is the default.
Serial Port 2	▶ Options available are: RS232 Support / RS422 Support / RS485 Support	
Serial Port 3 Configuration	Configures the system's serial port (COM port). The featured settings are:	
	Setting	Description
	Serial Port	Enables/disables the serial port. ▶ Enabled is the default.
Serial Port 4 Configuration	Configures the system's serial port (COM port). The featured settings are:	
	Setting	Description
	Serial Port	Enables/disables the serial port. ▶ Enabled is the default.
Serial Port 5 Configuration	Configures the system's serial port (COM port). The featured settings are:	
	Setting	Description
	Serial Port	Enables/disables the serial port. ▶ Enabled is the default.
Serial Port 6 Configuration	Configures the system's serial port (COM port). The featured settings are:	
	Setting	Description
	Serial Port	Enables/disables the serial port. ▶ Enabled is the default.

5.1.2.8. F81866 H/W Monitor

H/W Monitor monitors the computer's hardware status. Select this submenu to run a report of the info including CPU/system temperatures, CPU speed and other voltage info.

Aptio Setup Utility - Copyright (C) 2012 American Megatrends, Inc.

Main **Advanced** Chipset Boot Security Save & Exit

PC Health Status	
CPU Temperature	: +53 °C
System temperature1	: +47 °C
System temperature2	: +47 °C
VCORE	: +1.730 V
+3.3V	: +3.312 V
+1.05V	: +1.048 V
+5V	: +5.145 V
+12V	: +12.056 V
RTC Battery	: +3.264 V

←+ : Select Screen
↓ ↑ : Select Item
Enter: Select
+/- : Change Opt.
F1: General Help
F2: Previous Values
F9: Optimized Defaults
F10: Save & Exit
ESC: Exit

Version 2.15.1236. Copyright (C) 2012 American Megatrends, Inc.

5.1.2.9. F81216 Second Super IO Configuration

Use this submenu to enable/disable the computer's serial ports 7~10.

The featured submenus are:

Submenu	Description	
Serial Port 7 Configuration	Configures the computer's Serial Port 7 (COMA). The featured settings are:	
	Setting	Description
	Serial Port	Enables/disables the serial port. ▶ Enabled is the default.
Serial Port 8 Configuration	Configures the computer's Serial Port 8 (COMB). The featured settings are:	
	Setting	Description
	Serial Port	Enables/disables the serial port. ▶ Enabled is the default.
Serial Port 9 Configuration	Configures the computer's Serial Port 9 (COMC). The featured settings are:	
	Setting	Description
	Serial Port	Enables/disables the serial port. ▶ Enabled is the default.
Serial Port 10 Configuration	Configures the computer's Serial Port 10 (COMD). The featured settings are:	
	Setting	Description
	Serial Port	Enables/disables the serial port. ▶ Enabled is the default.

5.1.3. Chipset

The **Chipset** menu controls the system's chipset, including the north bridge and the south bridge.

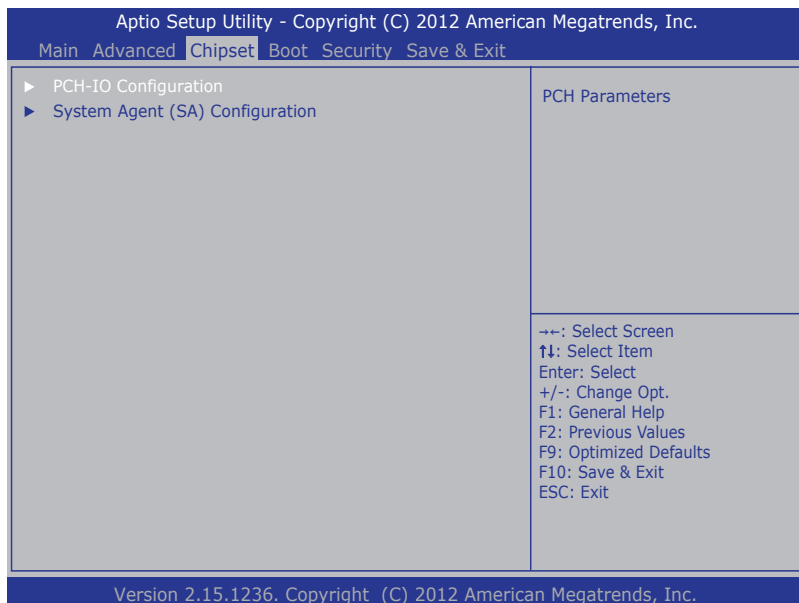

The featured submenus are **System Agent (SA) Configuration** and **PCH-IO Configuration**, which are covered in the following sections:

Submenu	Description
PCH-IO Configuration	Configures the PCH. ▶ See 5.1.3.1. PCH IO Configuration on page 68 for more details.
System Agent (SA) Configuration	Configures System Agent, i.e. the north bridge. ▶ See 5.1.3.2. System Agent (SA) Configuration on page 70 for more details.

WARNING: Wrong settings in these submenus may cause system malfunction.

5.1.3.1. PCH IO Configuration

Access this submenu to configure PCH parameters.

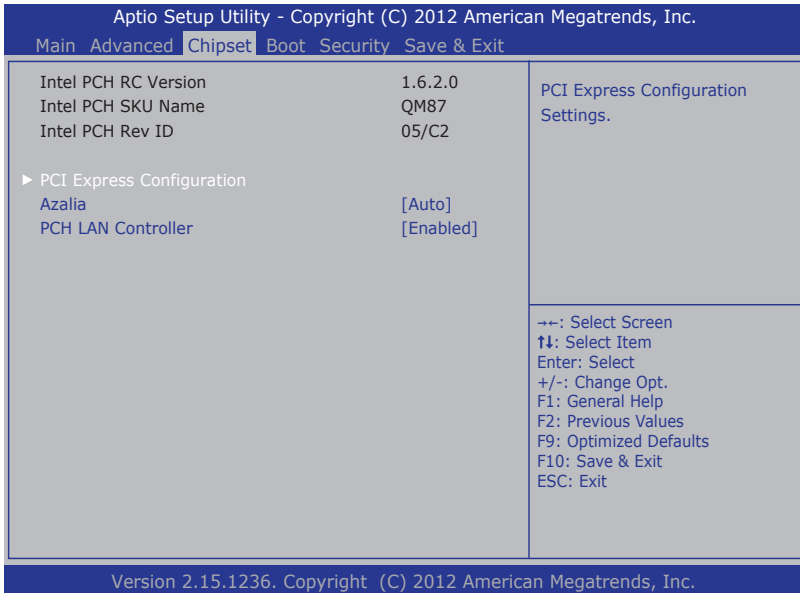

The featured submenu is:

Setting/Submenu	Description
PCI Express Configuration	See 5.1.3.1.1. PCI Express Configuration on page 69 .
Azalia	Control Detection of the Azalia device. Options are: Disabled = Azalia will be unconditionally disabled Enabled = Azalia will be unconditionally Enabled Auto (default)= Azalia will be enabled if present, disabled otherwise.
PCH LAN Controller	Enables/Disables onboard NIC. ▶ Enabled is the default.

5.1.3.1.1. PCI Express Configuration

Access this submenu for the following settings:

Setting	Description
PCI Express Root Port 5,6,7,8	Enables/disables PCI Express Root Port 5,6,7,8. ▶ Enabled is the default.
	▶ ASPM Support Options are: Disable : disables ASPM L0s : force all links to L0s state L1 : force all links to L1 state L0sL1 : force all links to L0s+L1 state Auto : BIOS auto configure (default) ▶ PCIe Speed Options are: Auto , Gen 1 , Gen 2 Auto is the default.

5.1.3.2. System Agent (SA) Configuration

Access this submenu to configure the system agent.

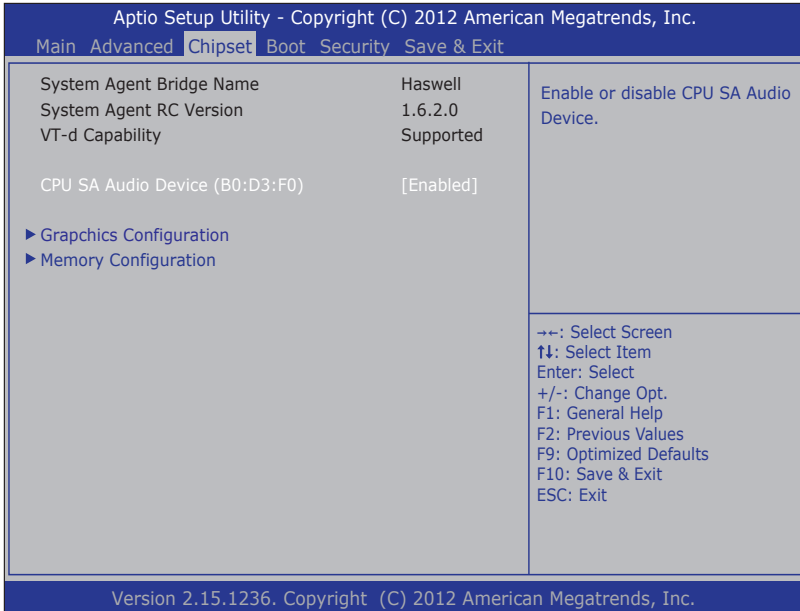

The featured settings are:

Setting / Submenu	Description
CPU SA Audio Device (B0:D3:F0)	Enables/Disables CPU SA Audio Device. ▶ Enabled is the default.
Graphics Configuration	Configures the system's graphics. See 5.1.3.2.1. Graphics Configuration on page 71 .
Memory Configuration	See 5.1.3.2.2. Memory Configuration on page 71 .

5.1.3.2.1. Graphics Configuration

Access this submenu to configure the system's Graphics. Select **Graphics Configuration** to view graphics info and accesses graphics settings.

The featured settings are:

Setting	Description
Primary Display	Select which of IGFX/PEG/PCI graphic device to be the Primary Display or SG for Switch Gfx. <ul style="list-style-type: none"> ▶ Options available are Auto(default), IGFX, PEG, PCIE, SG.
Internal Graphics	Keep IGD enabled based on the setup options. <ul style="list-style-type: none"> ▶ Options available are Auto(default), Disabled, Enabled.
Primary IGFX Boot Display	Sets the graphics device to activate during POST. <ul style="list-style-type: none"> ▶ This setting has no effect if an external graphics is present. ▶ CRT modes are only supported on the primary display. ▶ Options available are VBIOS Default(default), CRT, EFP and EFP2.
Second IGFX Boot device	Select second display device <ul style="list-style-type: none"> ▶ Options available are Disabled(default), CRT, EFP, LFP, EFP3, EFP2, LFP2.

5.1.3.2.2. Memory Configuration

Delivers the system's memory configuration that includes memory RC version, memory frequency, total memory, DIMM presence, CAS latency and minimum delay time.

5.1.4. Boot

Access this **Boot** menu to configure how to boot up the system such as boot device priority.

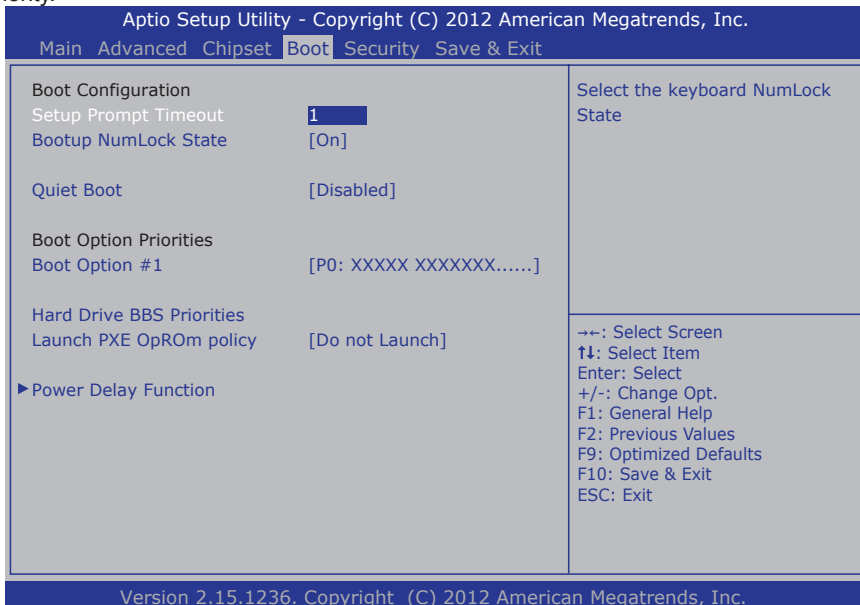

The featured settings and submenu are:

Group	Setting	Description
Boot Configuration	Bootup NumLock State	Sets whether to enable or disable the keyboard's NumLock state when the system starts up. ▶ Options available are On (default) and Off .
	Quiet Boot	Sets whether to display the POST (Power-on Self Tests) messages or the system manufacturer's full screen logo during booting. ▶ Leave it as Disabled , which is the default, to display the normal POST message.
Boot Option Priorities		Sets the boot priority among the available device types.
Launch PXE OpROM policy		Configures whether to launch the UEFI or legacy OpROM of PXE (Preboot eXecution Environment). ▶ Options available are Do not launch (default), and Legacy only .

Power Delay Function	Configures power delay function by the following settings:	
	Setting	Description
	Power Delay Function	Enables/disables power delay function: <ul style="list-style-type: none">▶ Enable is the default.▶ Select Disabled to manually power on/off..
Power on delay	Configures how much time should be delayed for the system to power on. <ul style="list-style-type: none">▶ Options available are Immediately, 04 Seconds (default), 08 Seconds and 16 Seconds.	

5.1.5. Security

The **Security** menu sets up the password for the system’s administrator account. Once the administrator password is set up, this BIOS Setup utility is limited to access and will ask for the password each time any access is attempted.

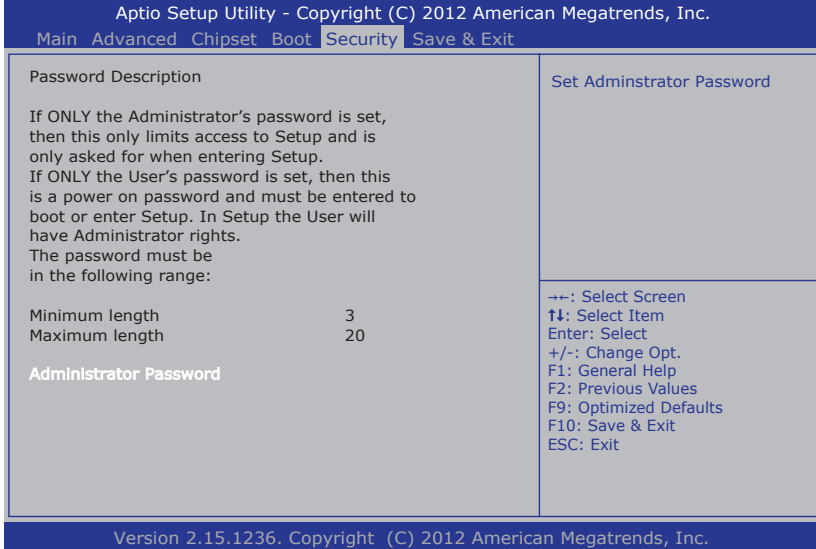

The featured setting is:

Setting	Description
Administrator Password	To set up an administrator password: <ol style="list-style-type: none"> 1. Select Administrator Password. An Create New Password dialog then pops up onscreen. 2. Enter your desired password that is no less than 3 characters and no more than 20 characters. 3. Hit [Enter] key to submit.

5.1.6. Save & Exit

The **Save & Exit** menu features a handful of commands to launch actions from the BIOS Setup utility regarding saving changes, quitting the utility and recovering defaults.

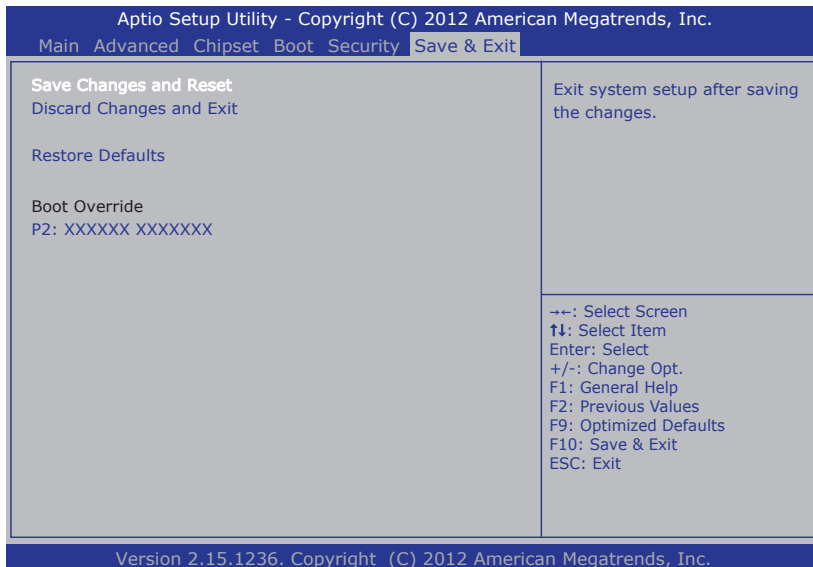

The featured settings are:

Setting	Description
Save Changes and Exit	Saves the changes and exits the BIOS setup. <ul style="list-style-type: none"> ▶ This is a command to launch action from the BIOS Setup utility rather than a setting.
Discard Changes and Exit	Quits the BIOS Setup utility without saving the change(s).
Restore Defaults	Restores all settings to factory defaults. <ul style="list-style-type: none"> ▶ This is a command to launch action from the BIOS Setup utility rather than a setting.
Boot Override	Shows a list of the available boot devices in the system so users can boot up the system by any of the listed devices regardless of the currently configured boot priority. <ul style="list-style-type: none"> ▶ This is a command to launch action from the BIOS Setup utility rather than a setting.

This page is intentionally left blank.

Appendices

Appendix A: WiFi-AT2350 Hardware Installation

To use Wi-Fi, hardware-wise the computer needs a Wi-Fi module installed. This appendix will guide you to install the Wi-Fi module **WiFi-AT2350**.

1. Remove the computer's top cover as described in [4.1.1. Open the Computer](#) on page [46](#).

The inside of the computer comes to view.

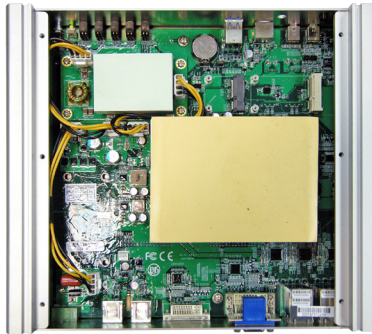

2. Find the two **PCI Express Mini-card** sockets for a WiFi module. The socket has a break among the connector.

Mini-card socket

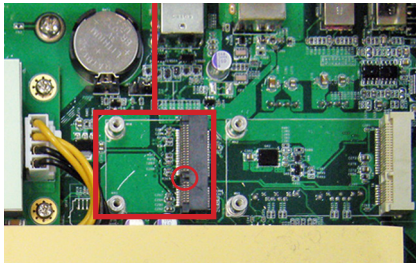

3. Prepare the **WiFi-AT2350** Wi-Fi module kit. The module is a half-size module of **PCI Express Mini-card** form factor, with two U.FL connectors, one is "MAIN", and the other is "AUX".

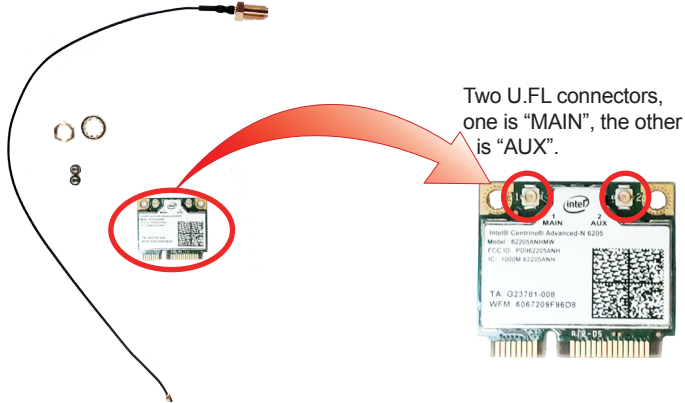

4. Plug the Wi-Fi module to the socket's connector by a slanted angle. Fully plug the module, and note the notch on the wireless module should meet the break of the connector.

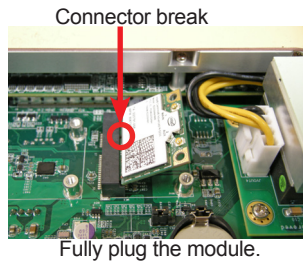

5. Press down the module and fix the module in place using two screws.



Appendices

- Remove one plastic plug from the computer's front panel to make an antenna hole. Keep the plastic plug for any possible restoration in the future.

Antenna holes stopped up by plugs



a view from the inside of the computer

An antenna hole w/o the plug



a view outside the computer

- Have the RF antenna. The antenna has an SMA connector on one end and an MHF connector on the other.

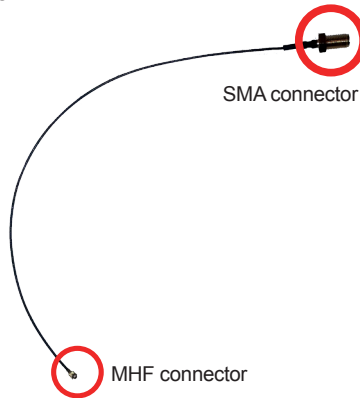

- Connect the RF antenna's MHF connector to the Wi-Fi module's "MAIN" connector.

Connect the RF antenna's MHF connector to the Wi-Fi module's "MAIN" connector.



- From the other end of the RF antenna, which is an SMA connector, remove the washer and the nut. Save the washer and nut for later use. Note the SMA connector has the form of a threaded bolt, with one flat side.

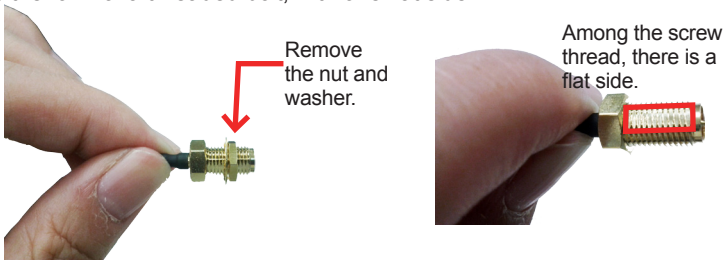

- Pull the SMA connector through the above mentioned antenna hole. Note to meet the aforesaid flattened side with the antenna hole's flat side.

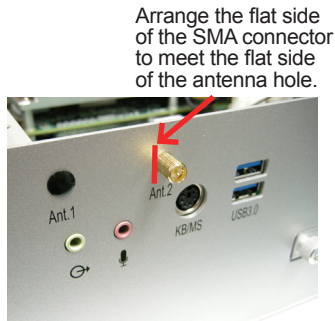

- Mount the washer first and then the nut to the SMA connector. Make sure the nut is tightened.



12. Have an external antenna. Screw and tightly fasten the antenna to the SMA connector.



Appendix B: Install mSATA Storage

To install an mSATA storage module to the computer:

1. Remove the top cover from the computer as described in [4.1.1. Open the Computer](#) on page [46](#).
2. See the illustration below and find the **PCI Express Mini-card** socket for an mSATA storage.

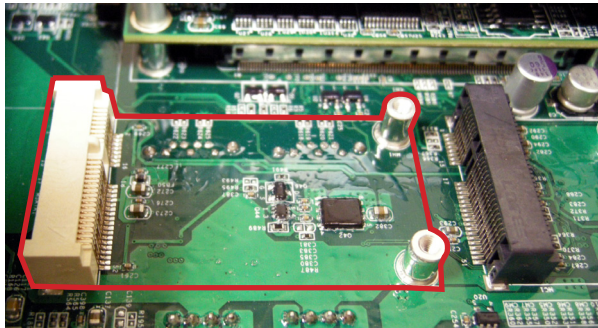

3. Confront the mSATA module's edge connector with the socket's connector. Align the module's key notch the connector's break.

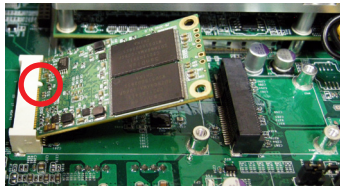

The module's key notch should meet the connector's break.

4. Fully plug the module until it cannot be plugged any more.



Fully plug the module.

5. Press down the module and fix the module in place using two screws.

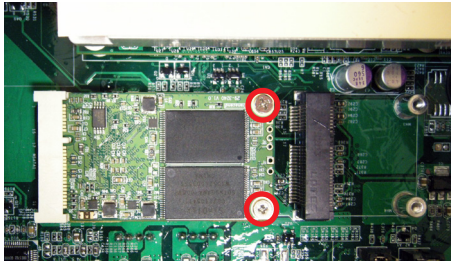

6. Restore the top cover to the computer.