ARTS-1450

Fanless Vehicle PC with Intel® Atom™ E3845

User's Manual

Version 1.0

P/N: 4012145000100P

2015.03



Revision History

Version	Release Time	Description
1.0	March, 2015	Initial release

Preface	iii
Copyright Notice	iii
Declaration of Conformity	iii
CE	iii
FCC Class A.....	iii
RoHS	iv
SVHC / REACH	iv
Important Safety Instructions	v
Warning	v
Replacing Lithium Battery.....	vi
Technical Support	vi
Warranty	vii
Chapter 1 - Introduction	1
1.1. Product Highlights	2
1.2. About this Manual	2
1.3. Specifications	3
1.5. Ordering Information.....	5
1.5.1. Optional Accessories	5
1.5.2. Configure-to-Order Service.....	6
Chapter 2 - Getting Started	7
2.1. Dimensions.....	8
2.2. Take A Tour	9
2.3. Driver Installation Notes	11
Chapter 3 - System Configuration	13
3.1. Board Layout	14
3.1.1. Main Boards.....	14
3.2. Jumpers and Connectors	16
3.2.1. Jumpers	16
3.2.2. Connectors.....	20
Chapter 4 - Installation and Maintenance	39
4.1. Install Hardware.....	40
4.1.1. Open the Computer	40
4.1.2. Install/uninstall SIM Card	41
4.1.3. Install SATA SSD	43
4.1.4. Disassemble SSD bracket	45
4.1.5. Install Memory Module on CPU Module	46
4.1.6. Insert a SD card.....	47
4.2. Mount the Computer.....	48
4.3. Wire DC-in Power Source.....	49
4.3.1 Vehicle Application	49
4.3.2 Automation Application.....	50

Chapter 5 - BIOS 51

- 5.1. Main 54
- 5.2. Advanced 55
 - 5.2.1. Boot Configuration 56
 - 5.2.2. PCI Express Configuration 56
 - 5.2.3. SATA Configuration 56
 - 5.2.4. SIO Fintek 81216 57
 - 5.2.5. H/W Monitor 57
- 5.3. Security 58
- 5.4. Power 59
- 5.5. Boot 60
- 5.6. Exit 61

Appendices 63

- Appendix A: HSPA-1450 Hardware Installation 64
- Appendix B: WIFI-AT2350 Hardware Installation 69
- Appendix C: GPS Module Hardware Installation 74
- Appendix D: CANBUS Module Hardware Installation 77

Copyright Notice

All Rights Reserved.

The information in this document is subject to change without prior notice in order to improve the reliability, design and function. It does not represent a commitment on the part of the manufacturer.

Under no circumstances will the manufacturer be liable for any direct, indirect, special, incidental, or consequential damages arising from the use or inability to use the product or documentation, even if advised of the possibility of such damages.

This document contains proprietary information protected by copyright. All rights are reserved. No part of this document may be reproduced by any mechanical, electronic, or other means in any form without prior written permission of the manufacturer.

Declaration of Conformity

CE

The CE symbol on the computer indicates that it is in compliance with the directives of the Union European (EU). A Certificate of Compliance is available by contacting Technical Support.

This product has passed the CE test for environmental specifications when shielded cables are used for external wiring. We recommend the use of shielded cables. This kind of cable is available from ARBOR. Please contact your local supplier for ordering information.

Warning

This is a class A product. In a domestic environment this product may cause radio interference in which case the user may be required to take adequate measures.

FCC Class A

This device complies with Part 15 of the FCC Rules. Operation is subject to the following two conditions:

- (1) This device may not cause harmful interference, and
- (2) This device must accept any interference received, including interference that may cause undesired operation.

NOTE:

This equipment has been tested and found to comply with the limits for a Class A digital device, pursuant to Part 15 of the FCC Rules. These limits are designed to provide reasonable protection against harmful interference when the equipment is operated in a commercial environment. This equipment generates, uses, and can radiate radio frequency energy and, if not installed and used in accordance with the instruction manual, may cause harmful interference to radio communications. Operation of this equipment in a residential area is likely to cause harmful interference in which case the user will be required to correct the interference at his own expense.

RoHS

ARBOR Technology Corp. certifies that all components in its products are in compliance and conform to the European Union's Restriction of Use of Hazardous Substances in Electrical and Electronic Equipment (RoHS) Directive 2002/95/EC.

The above mentioned directive was published on 2/13/2003. The main purpose of the directive is to prohibit the use of lead, mercury, cadmium, hexavalent chromium, polybrominated biphenyls (PBB), and polybrominated diphenyl ethers (PBDE) in electrical and electronic products. Member states of the EU are to enforce by 7/1/2006.

ARBOR Technology Corp. hereby states that the listed products do not contain unintentional additions of lead, mercury, hex chrome, PBB or PBDB that exceed a maximum concentration value of 0.1% by weight or for cadmium exceed 0.01% by weight, per homogenous material. Homogenous material is defined as a substance or mixture of substances with uniform composition (such as solders, resins, plating, etc.). Lead-free solder is used for all terminations (Sn(96-96.5%), Ag(3.0-3.5%) and Cu(0.5%)).

SVHC / REACH

To minimize the environmental impact and take more responsibility to the earth we live, Arbor hereby confirms all products comply with the restriction of SVHC (Substances of Very High Concern) in (EC) 1907/2006 (REACH --Registration, Evaluation, Authorization, and Restriction of Chemicals) regulated by the European Union.

All substances listed in SVHC < 0.1 % by weight (1000 ppm)

Important Safety Instructions

Read these safety instructions carefully

1. Read all cautions and warnings on the equipment.
2. Place this equipment on a reliable surface when installing. Dropping it or letting it fall may cause damage
3. Make sure the correct voltage is connected to the equipment.
4. For pluggable equipment, the socket outlet should be near the equipment and should be easily accessible.
5. Keep this equipment away from humidity.
6. The openings on the enclosure are for air convection and protect the equipment from overheating. **DO NOT COVER THE OPENINGS.**
7. Position the power cord so that people cannot step on it. Do not place anything over the power cord.
8. Never pour any liquid into opening. This may cause fire or electrical shock.
9. Never open the equipment. For safety reasons, the equipment should be opened only by qualified service personnel.
10. If one of the following situations arises, get the equipment checked by service personnel:
 - a. The power cord or plug is damaged.
 - b. Liquid has penetrated into the equipment.
 - c. The equipment has been exposed to moisture.
 - d. The equipment does not work well, or you cannot get it to work according to the user's manual.
 - e. The equipment has been dropped or damaged.
 - f. The equipment has obvious signs of breakage.
11. Keep this User's Manual for later reference.

Product Heat



The computer generates heat during operation. Contact the computer's chassis with your body could cause discomfort or even a skin burn.

Warning

The Box PC and its components contain very delicately Integrated Circuits (IC). To protect the Box PC and its components against damage caused by static electricity, you should always follow the precautions below when handling it:

1. Disconnect your Box PC from the power source when you want to work on the inside.
2. Use a grounded wrist strap when handling computer components.
3. Place components on a grounded antistatic pad or on the bag that came with the Box PC, whenever components are separated from the system.

Replacing Lithium Battery

Incorrect replacement of the lithium battery may lead to a risk of explosion.

The lithium battery must be replaced with an identical battery or a battery type recommended by the manufacturer.

Do not throw lithium batteries into the trash can. It must be disposed of in accordance with local regulations concerning special waste.

Technical Support

If you have any technical difficulties, please consult the user's manual first at:

<http://www.arbor.com.tw>

Please do not hesitate to call or e-mail our customer service when you still cannot find out the answer.

<http://www.arbor.com.tw>

E-mail:info@arbor.com.tw

Warranty

This product is warranted to be in good working order for a period of one year from the date of purchase. Should this product fail to be in good working order at any time during this period, we will, at our option, replace or repair it at no additional charge except as set forth in the following terms. This warranty does not apply to products damaged by misuse, modifications, accident or disaster.

Vendor assumes no liability for any damages, lost profits, lost savings or any other incidental or consequential damage resulting from the use, misuse of, or inability to use this product. Vendor will not be liable for any claim made by any other related party.

Vendors disclaim all other warranties, either expressed or implied, including but not limited to implied warranties of merchantability and fitness for a particular purpose, with respect to the hardware, the accompanying product's manual(s) and written materials, and any accompanying hardware. This limited warranty gives you specific legal rights.

Return authorization must be obtained from the vendor before returned merchandise will be accepted. Authorization can be obtained by calling or faxing the vendor and requesting a Return Merchandise Authorization (RMA) number. Returned goods should always be accompanied by a clear problem description.

This page is intentionally left blank.

Chapter 1

Introduction

1.1. Product Highlights

- Fanless and rugged design
- Intel® Atom™ Processor E3845 quad-core 1.91GHz
- Dual SIM cards + dual WWAN modules supported
- Wide operating temperature : -40°C~70°C
- Outside accessible SD and SIM slots supported
- 3 x mini-PCIe sockets
- Optional uBlox GPS Module, support GPS, Glonass, Galileo, BeiDou and QZSS signals
- Compliant with MIL-STD-810G
- Optional CAN BUS2.0B and 4-channel CCTV
- 4 x COM, 1 x USB3.0, 2 x USB2.0, 4-in/4-out GPIO



1.2. About this Manual

This manual is meant for the experienced users and integrators with hardware knowledge of personal computers. If you are not sure about the description herein, consult your vendor before further handling.

We recommend that you keep one copy of this manual for the quick reference for any necessary maintenance in the future. Thank you for choosing ARBOR products.

1.3. Specifications

System	
CPU	Soldered onboard Intel® Atom™ E3845 quad-core 1.91GHz
BIOS	Insyde BIOS
Graphic	Integrated Intel® HD Gen. 7 Graphics
Memory	1 x 204-pin SO-DIMM sockets, supporting DDR3L 1333/1600 MHz, up to 8GB SDRAM
Storage	<ul style="list-style-type: none"> • 1 x mSATA. • 1 x Serial ATA port with 300MB/s HDD transfer rate
LAN	<ul style="list-style-type: none"> • 1 x Intel® i210IT GbE Ethernet controller
Watchdog Timer	1 ~ 255 levels reset
I/O Ports	
Serial Port	<ul style="list-style-type: none"> • 2 x RS-232/485 ports w/ DB-9 connectors, rear side • 2 x RS-232 ports w/ DB-9 connectors, rear side Optional : 1 x CAN BUS2.0B w/ DB-9 connector Optional : 1 x 4-ch CCTV w/ DB-9 connector
USB Port	<ul style="list-style-type: none"> • 1 x type A USB 3.0 port, front side • 2 x type A USB 2.0 ports, rear side
LAN Port	<ul style="list-style-type: none"> • 1 x RJ-45 port for GbE, rear side
Video Port	1 x DVI-D female connector, rear side 1 x VGA with DB15 female connector, rear side
Digital I/O	1 x 8-bit digital I/O, 4-in/4-out w/ DB-15 Male connector, 2KV isolated protection, front side
Antenna	5 x SMA-female connectors' holes for external antennas, front side
Audio	2 x 3.5mm phone jacks for Line-out & MIC-in (2W pre-amplified), rear side
Expansion Bus	<ul style="list-style-type: none"> • 1 x Mini-PCIe slot for optional Wi-Fi/Bluetooth module • 2 x Mini-PCIe slot interconnected with SIM card sockets for optional HSPA/LTE module • 2 x SIM sockets (outside accessible)
Storage	
Type	<ul style="list-style-type: none"> • 1 x 2.5" drive bay for SSD • 1 x mSATA • 1 x outside accessible SD socket with cover

Introduction

Qualification	
Certification	CE, FCC Class A, E13 Mark
Environment	
Operating Temp.	-40°C ~ 70°C (-40°F ~ 158°F), ambient w/ air flow, w/SSD
Storage Temp.	-40~80°C (-40 ~ 185°F)
Relative Humidity	5 ~ 95% @ 70°C (non-condensing)
Vibration	Operating: MIL-STD-810G, Method 514.6, Category 4 and EN61373 Category 1 Class B
	Non-operating: MIL-STD-810G, Method 514.6, Category 24 minimum integrity test
Shock	Operating: MIL-STD-810G, Method 516.6, Procedure functional shock=20g
	Non-operating : MIL-STD-810G, Method 516.6, Procedure V, crash hazard shick test=75g
Mechanical	
Construction	Aluminum alloy
Mounting	Wall-mount
Weight	1.5 kg (3.30 lb)
Dimensions (W x D x H)	200 x 54 x 180 mm (7.87" x 2.13" x 7.09")
Power Requirement	
Power Input	DC 9~36V input, w/ 3-pin terminal block
Power Consumption	Max. 30W
Power Management	Power ignition, power on/off delay controlled by software

1.4. Inside the Package

Upon opening the package, carefully inspect the contents. If any of the items is missing or appears damaged, contact your local dealer or distributor. The package should contain the following items:



Fanless Vehicle PC

ARTS-1450



One Driver CD
One User's Manual

1.5. Ordering Information

ARTS-1450

Vehicle Barebone System w/ Intel® Atom™ Quad-core E3845 SoC, w/o memory and storage

1.5.1. Optional Accessories

The following items are normally optional, but some vendors may include them as a standard package, or some vendors may not carry all the items.









PAC-P065W

19V/3.4A 65W AC/DC adapter kit



1.5.2. Configure-to-Order Service

Make the computer more tailored to your needs by selecting one or more components from the list below to be fabricated to the computer.

80 GB SSD	Intel® 2.5" 80GB SATAIII SSD kit	
MM-3IL-2G	Industrial-grade DDR3L-1600 2GB SDRAM	
MM-3IL-4G	Industrial-grade DDR3L-1600 4GB SDRAM	
MM-3IL-8G	Industrial-grade DDR3L-1600 8GB SDRAM	
WIFI-AT2350	Atheros AR9462 WiFi module w/ 20cm & 30cm internal wiring	
HSPA-1450	HSUPA 3.75G module kit & internal wiring	
GPS-1450	U-BLOX GPS Kit for ARTS-1450	
ANT-D11	1 x WiFi Dual-band 2.4G/5G antenna	
CAN-1450	CAN BUS 2.0B kit	
CCTV-1450	4_ch CCTV Cameras input and output	

Chapter 2

Getting Started

2.1. Dimensions

The following illustration shows the dimensions of the computer, with the measurements in width, depth, and height called out.

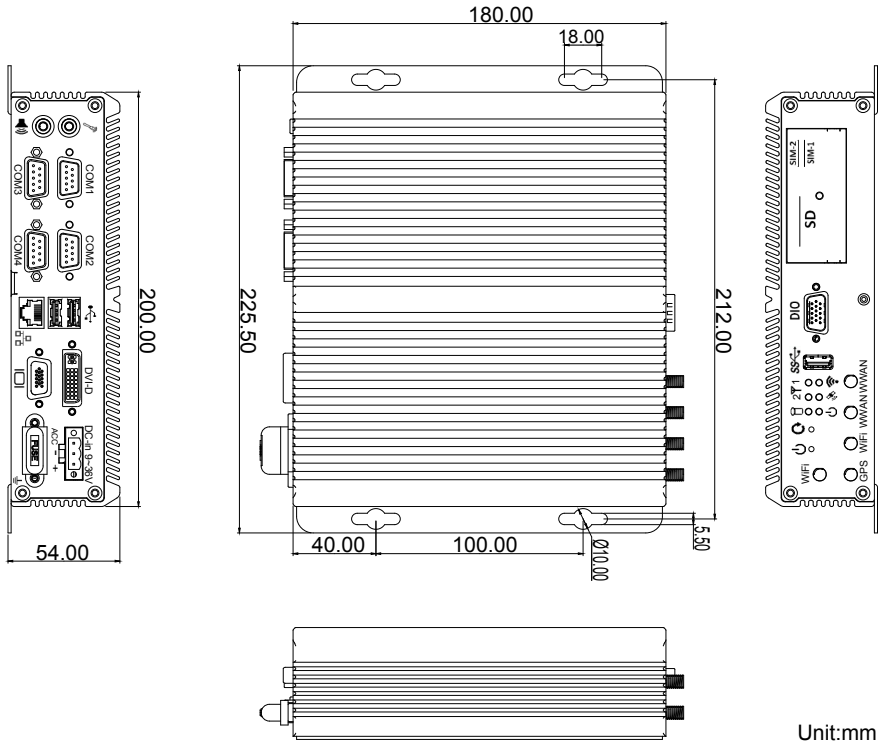

Unit:mm

2.2. Take A Tour

The computer has some I/O ports, status LED light and controls on the front and rear panel. The following illustrations show all the components called out .

Front View

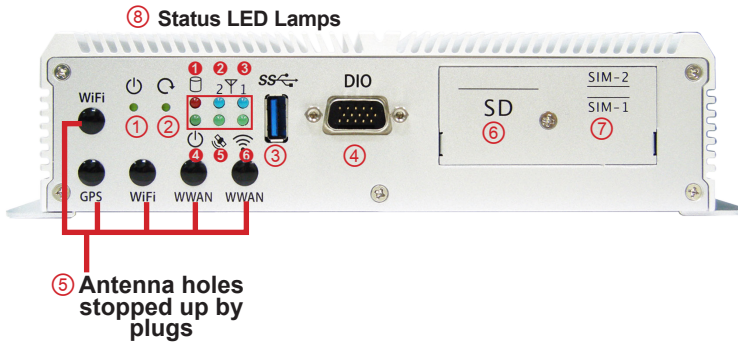

- I/O

No.	Description	No.	Description
①	Power button	⑤	Antenna holes stopped up by plugs
②	Reset button (accessible with a pin)	⑥	SD card slot
③	USB 3.0 port	⑦	SIM1/2 card slots
④	DIO port	⑧	LED Indicators

- Status LED Lamps:

No.	LED Color	Description
①	Red	This LED flashes red when SSD is being accessed.
②	Blue	This LED lights/flashes blue when 3G is on/communicating.
③	Blue	This LED lights/flashes blue when 3G is on/communicating.
④	Green	This LED lights green when Power is on.
⑤	Green	This LED lights/flashes green when GPS is on/communicating.
⑥	Green	This LED lights/flashes green when WiFi is on/communicating.

Rear View

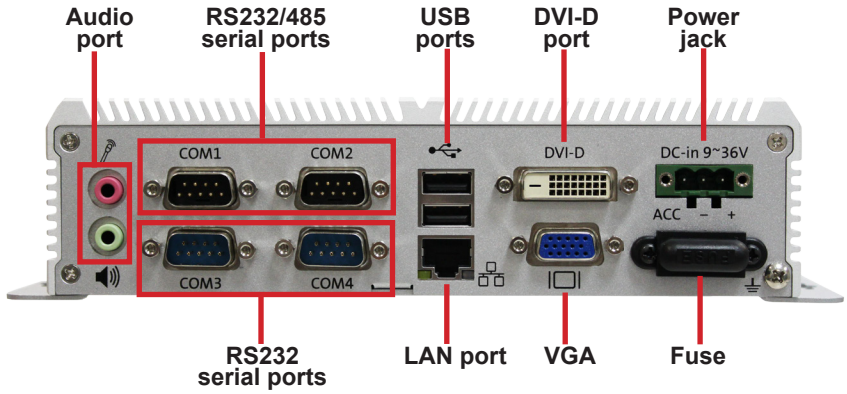

2.3. Driver Installation Notes

The computer supports the operating systems of Windows 7. Find the necessary device drivers on the CD that comes with your purchase.

Paths to find device drivers on CD:

Windows 7	
Device	Driver Path
Chipset	\\Chipset\\SetupChipset.exe
Graphic	32Bit: \\Graphic\\WIN7_32bit\\Intel_EMGD_WIN7_32bit_V_36_15_0_1073\\Setup.exe
	64Bit: \\Graphic\\WIN7_64bit\\Intel_EMGD_Win7_64bit_V_37_15_0_1073\\Setup.exe
Audio	32Bit : \\Audio\\32bit_Win7_Win8_Win81_R275.exe
	64Bit : \\Audio\\64bit_Win7_Win8_Win81_R275.exe
Ethernet	32Bit : \\Ethernet\\Win7\\ (PROWin32.exe)
	64Bit: \\Ethernet\\Win7\\ (PROWinx64.exe)
Processor IO	32Bit : \\Processor IO\\Win7\\545318_545318_Intel_Processor_Win7_IO_Drivers_Gold_v2_0\\Intel Processor Win7 IO Drivers 32Bit.msi
	64Bit: \\Processor IO\\Win7\\545318_545318_Intel_Processor_Win7_IO_Drivers_Gold_v2_0\\Intel Processor Win7 IO Drivers 64Bit.msi
TXE	\\Intel_TXE_Win7_32&64bit_V1.1.0.10885\\SetupTXE.exe
USB3.0	\\USB3.0\\Setup.exe
HSIC	Device Manager --> Update Driver Software --> \\WINUSB Driver\\

Windows 7	
Device	Driver Path
GPS	\\GPS\\Driver\\ubloxGnss_usbcdc_windows_3264_v1.2.0.8.exe
GPS Application	\\GPS\\Application\\u-center_v8.11.exe
3G Module	\\3G Module\\Driver\\Setup.exe
CAN BUS	\\CAN BUS2.0B Module\\Setup.exe

This page is intentionally left blank.

Chapter 3

System Configuration

3.1. Board Layout

The engine of the computer is constructed by a main board, FMB-i2310 Following in this section you will be guided through the main boards of the computer.

3.1.1. Main Boards

The Main board for ARTS-1450 is FMB-i2310.

Board Top

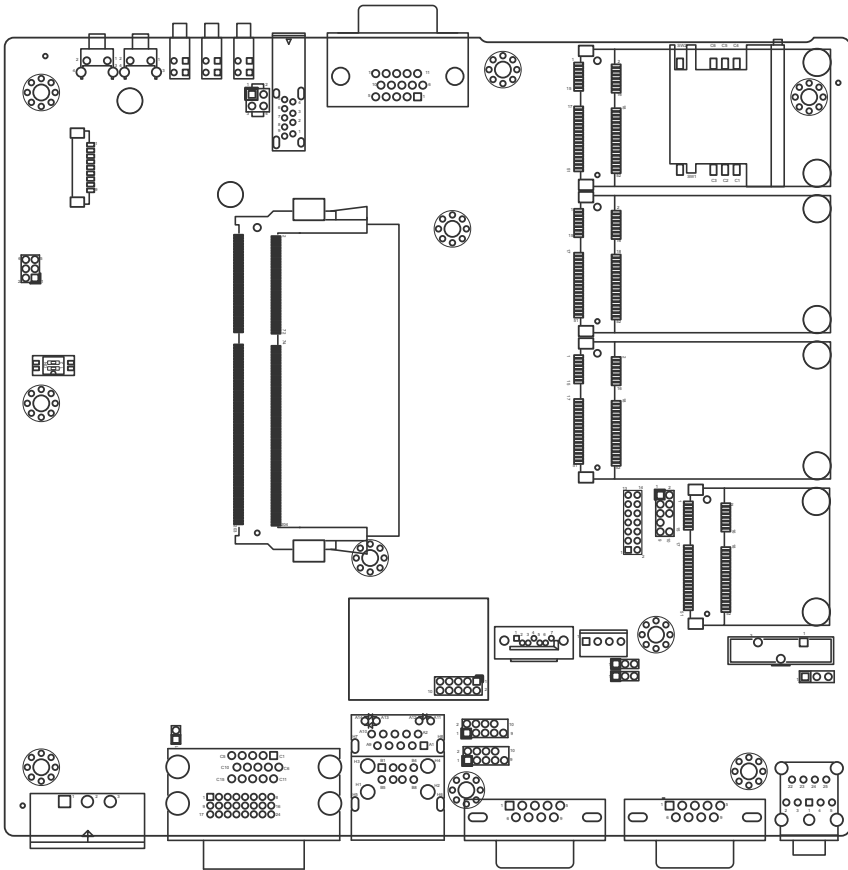

Board Bottom

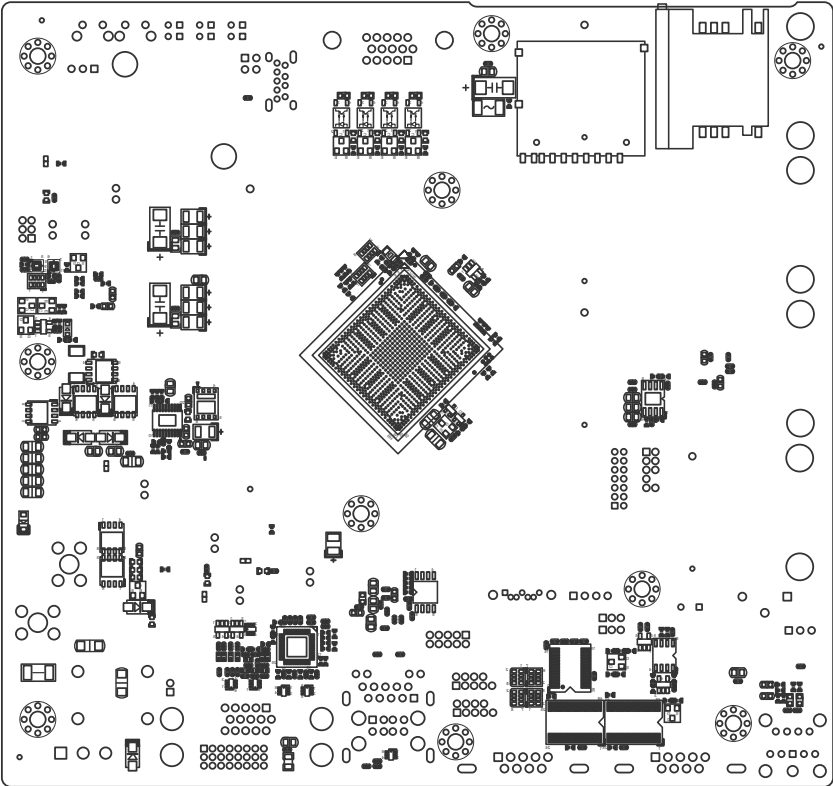

3.2. Jumpers and Connectors

The Main board FMB-i2310 comes with some connectors to join devices and some jumpers to alter the computer's hardware configuration. The following in this chapter will explicate each of these components.

3.2.1. Jumpers

JBAT1

Function: CMOS Setting

Jumper Type: Onboard 2.54mm-pitch 1x3-pin header



Setting: Short pin 1 and pin 2 to keep CMOS.
(The default setting.)



Short pin 2 and pin 3 to clear CMOS.



Board Top

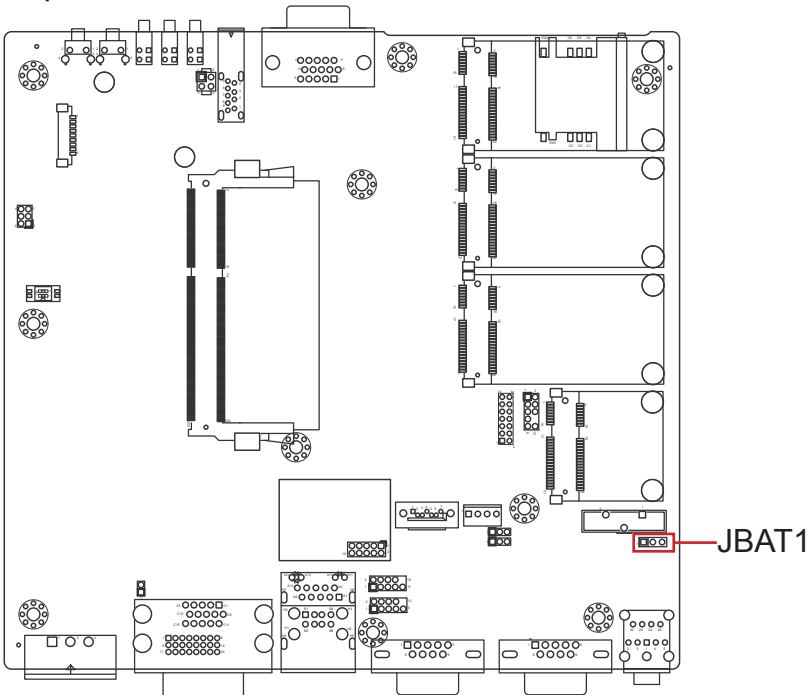

JTERM1/2

Function: COM1/2 RS485 Terminator Selector
Jumper Type: Onboard 2.00mm-pitch 1x3-pin header



Setting: 1-2 Normal Mode (Default)



2-3 120 ohm Terminal Mode



Board Top

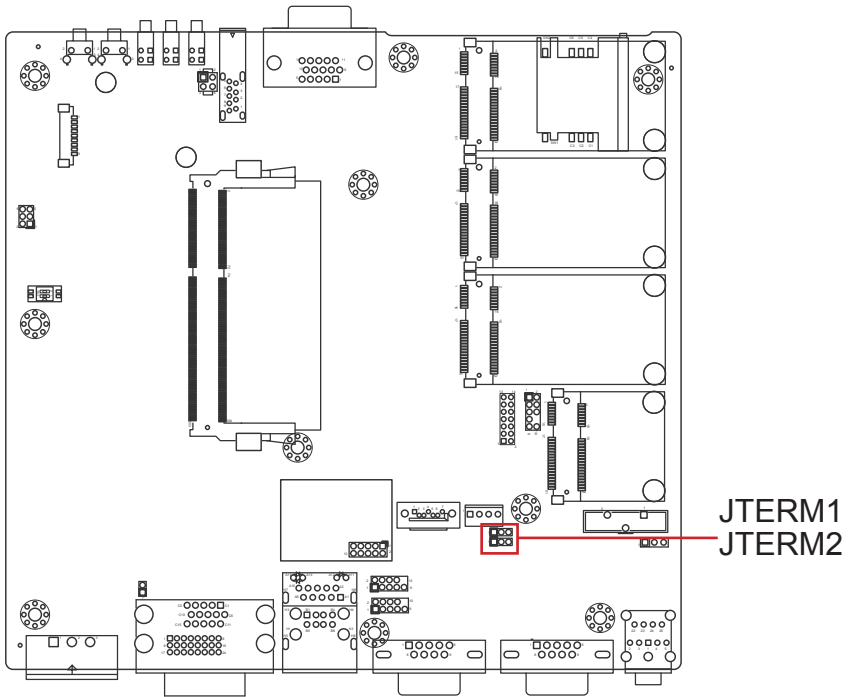

System Configuration

SW1

Function: Input Voltage Level Selector
Switch Type:



Setting: 1 OFF No any battery low detection (Default)
2 OFF



1 ON Lower Than 22V will Alarm
2 OFF



2 ON Lower Than 11V will Alarm
1 OFF



Board Top

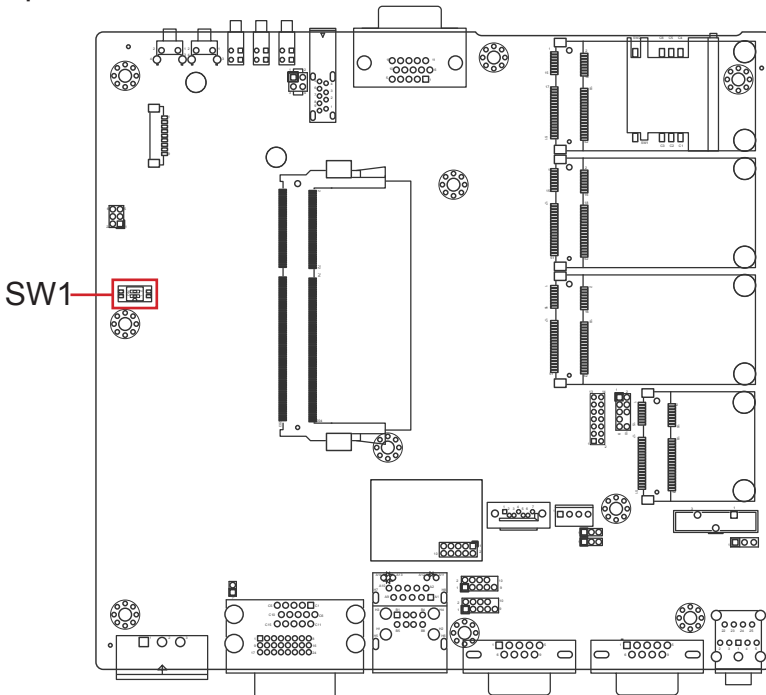

JACCON1

Function: Vehicle Acc mode selection



Jumper Type: Onboard 2.00mm-pitch 2-pin header

Setting: Open: for Vehicle (default), without jumper

Close: for Automation, with jumper

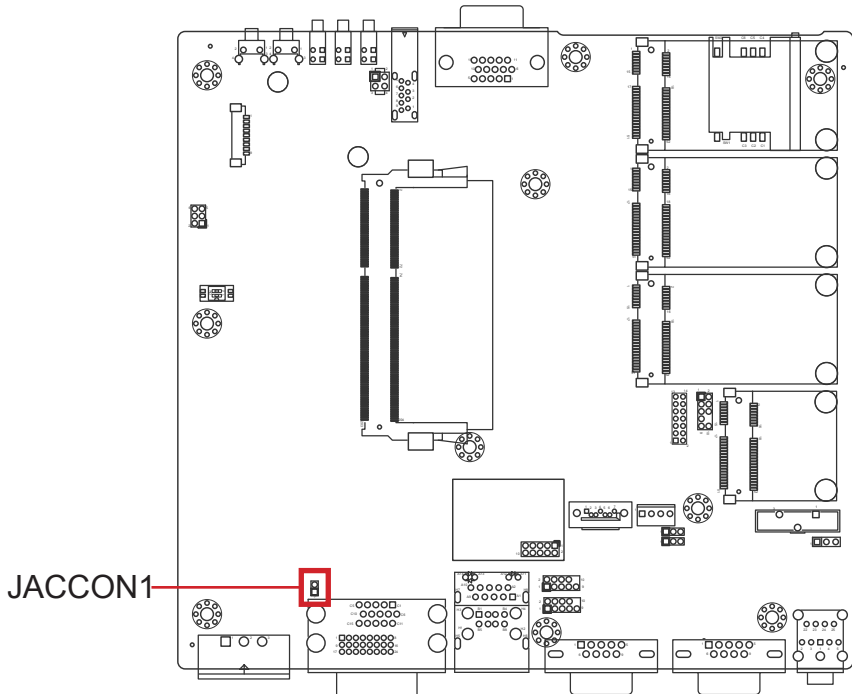

3.2.2. Connectors

JPIC1

Function: External PIC programming pin header

Connector Type: Onboard 2.00mm-pitch 2x3-pin header



Setting:

Pin	Description	Pin	Description
1	PIC_TX	2	ICSP-CLK
3	ICSP-DAT	4	GND
5	VCC5	6	MCU_RST

Board Top

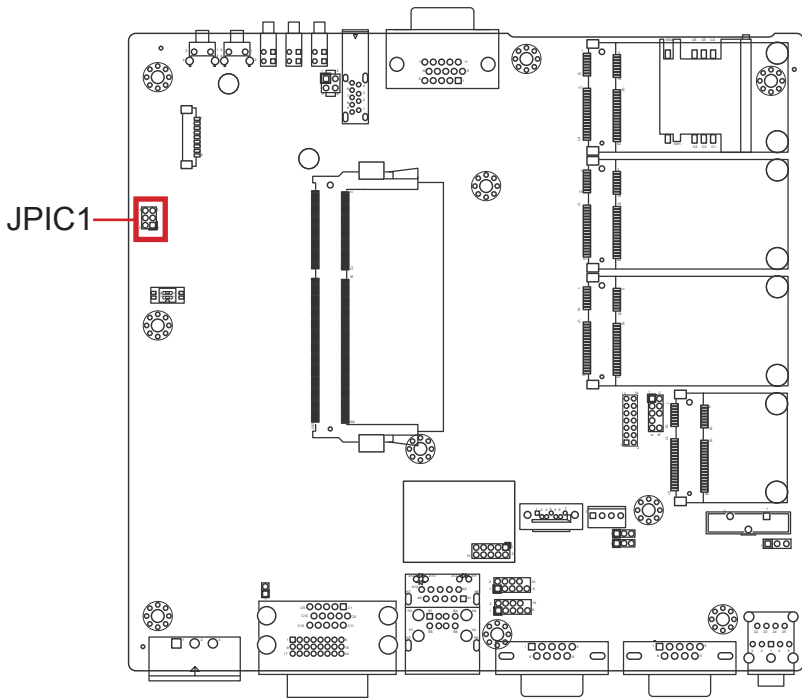

DGP1

Description: External 80 port pin header

Connector Type: 2.0mm pitch 2x5-pin header

Pin	Description	Pin	Description
1	CLK	2	GND
3	FRAME#	4	LAD0
5	PLTRST#	6	NC
7	LAD3	8	LAD2
9	VCC3	10	LAD1

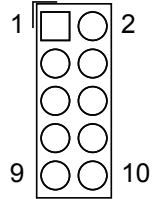

Board Top

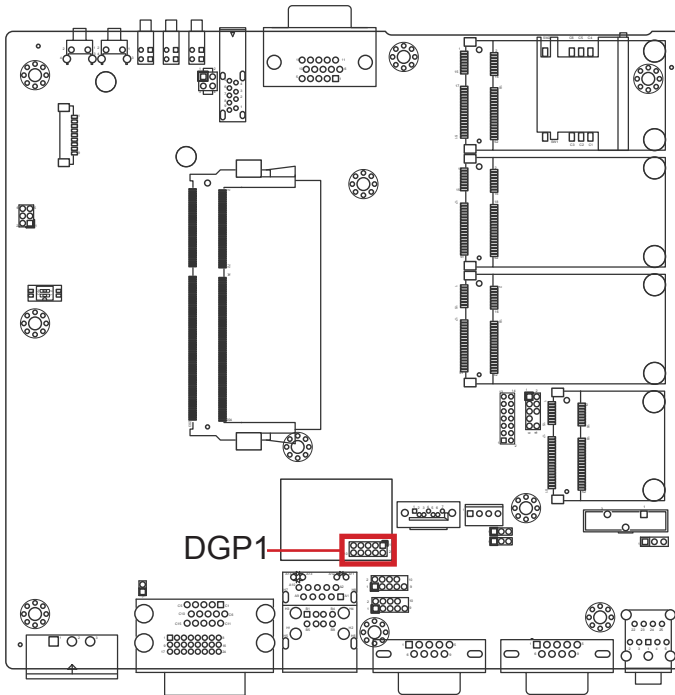

RSTB1

Function: Power And Reset Button

Connector Type: Onboard 2.54 mm-pitch 2x2-pin header



Setting:

Pin	Description	Pin	Description
1	SYS_RESET#	2	GND
3	PWR_IN_SW#	4	GND

Board Top

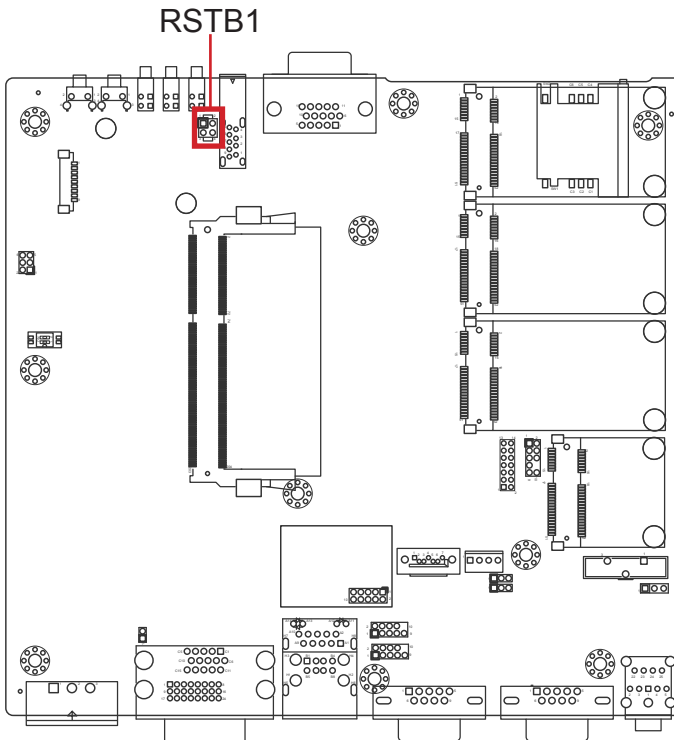

COM1&2

Function: RS-232/485 Port

Connector Type: External 9-pin D-sub male connector

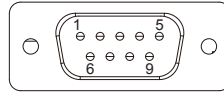

Pin	Description	Pin	Description
1	DCD / (RS485-)	6	DSR
2	RXD / (RS485+)	7	RTS
3	TXD	8	CTS
4	DTR	9	RI
5	GND		

Board Top

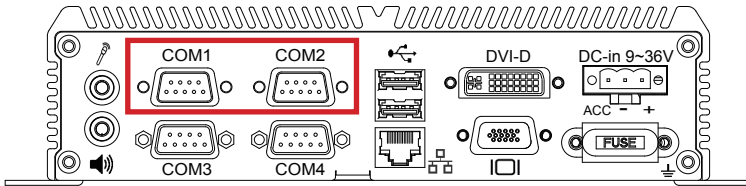

PWRIN1

Function: Power Input Connector
Connector Type: 3-pin terminal block

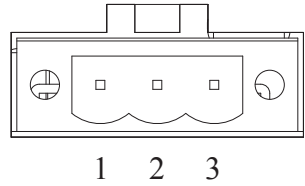

Pin	Description
1	VIN+
2	VIN-
3	ACC_ON

Board Top

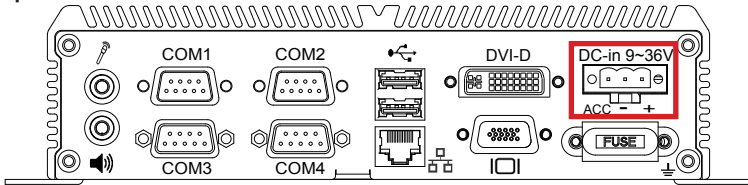

GPS1

Description: GPS Port Connector

Connector Type: Onboard 1.25mm pitch 9-pin wafer connector

Pin	Description
1	N.C.
2	N.C.
3	GND
4	N.C.
5	VCC5
6	VCC3
7	USB_DP
8	USB_DN
9	TIMEPULSE

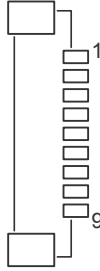

Board Top

GPS1

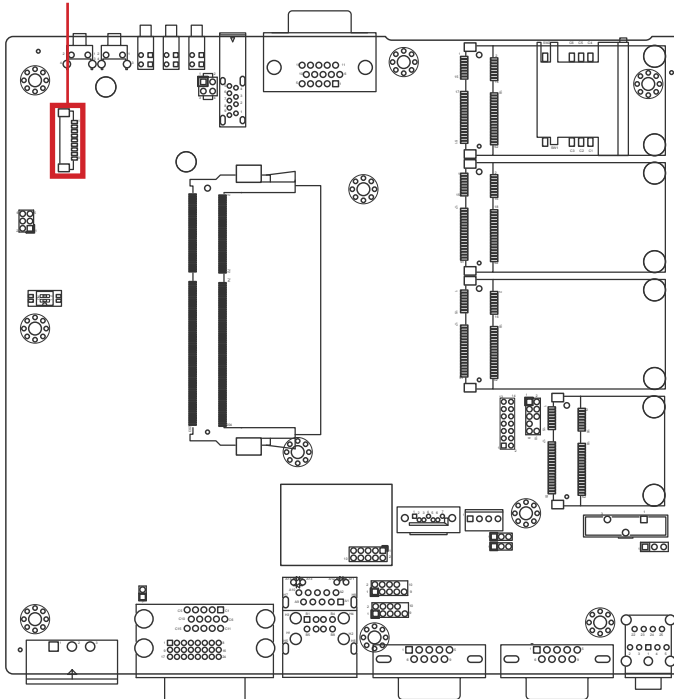

JCBUS1

Function: CAN BUS Header for module side

Connector Type: Onboard 2.0mm pitch 2x7-pin header

Pin	Description	Pin	Description
1	BATTERY 12V	2	K_LINE
3	CAN_ICS	4	L_LINE
5	GND	6	BATTERY GND
7	N.C.	8	N.C.
9	TX	10	N.C.
11	RX	12	CAN_H
13	VCC5	14	CAN_L

Board Top

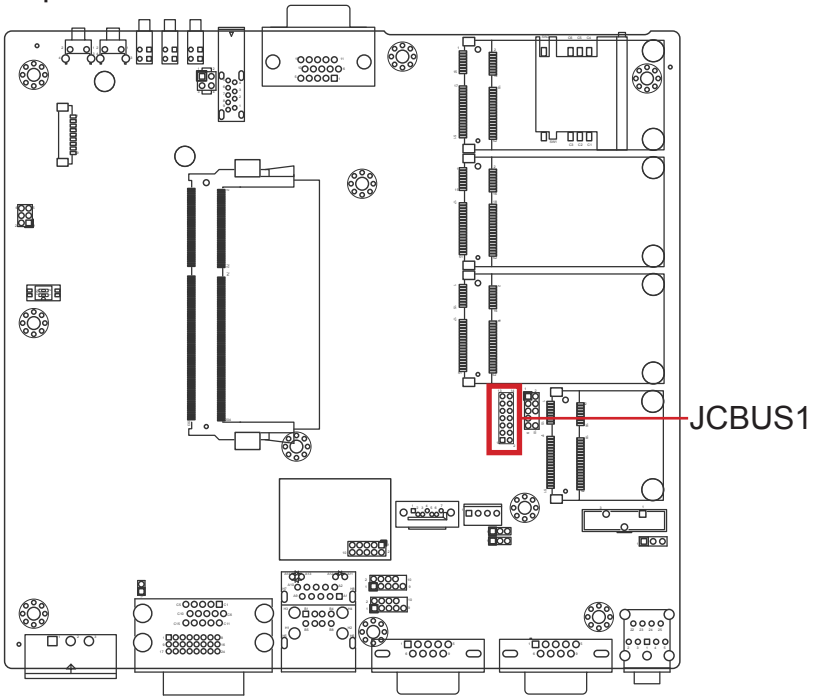

JCBUS2

Function: CAN BUS Header for cable side

Connector Type: Onboard 2.0mm pitch 2x5-pin header

Pin	Description	Pin	Description
1	K_LINE	2	BATTERY 12V
3	L_LINE	4	N.C.
5	GND	6	N.C.
7	CAN_H	8	N.C.
9	CAN_L	10	BATTERY GND

Board Top

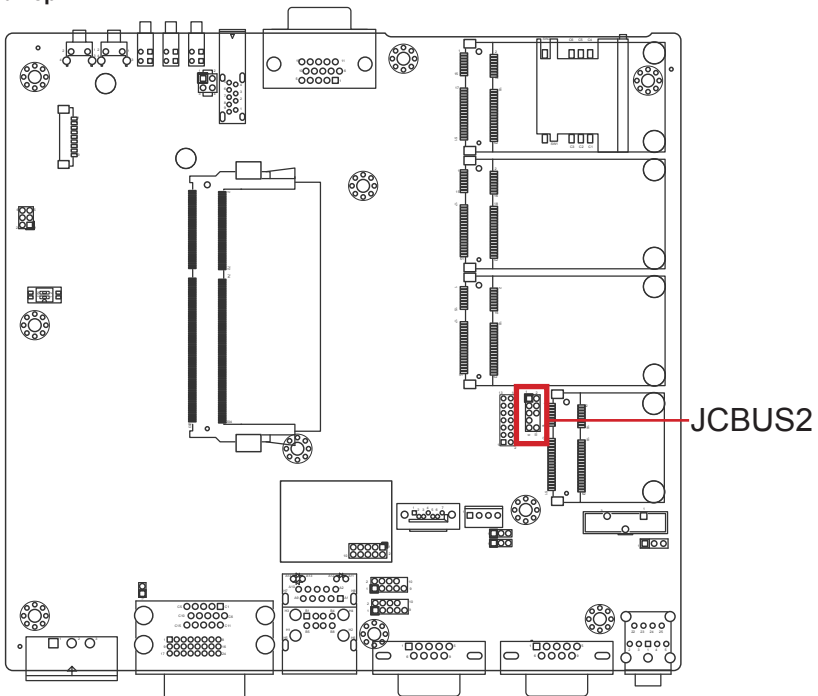

System Configuration

COM3&4

Function: RS-232 Pin header

Connector Type: Onboard 2.0mm pitch 2x5-pin header

Pin	Description	Pin	Description
1	DCD	2	RXD
3	TXD	4	DTR
5	GND	6	DSR
7	RTS	8	CTS
9	RI	10	N/C

Board Top

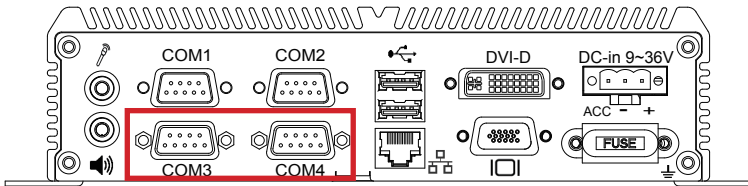

JDIO1

Description: DIGITAL SINGAL INPUT AND OUTPUT

Connector Type: DSUB-15 Male Connector

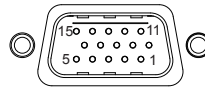

Pin	Description	Pin	Description	Pin	Description
1	PDI1	6	PDO1	11	VCC12
2	PDI2	7	PDO2	12	VCC12
3	PDI3	8	PDO3	13	VCC12
4	PDI4	9	PDO4	14	GND
5	ISO_GND	10	ISO_GND	15	GND

Board Top

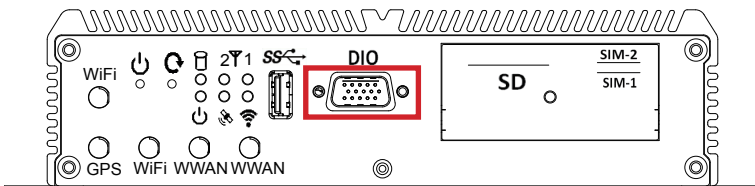

SATAPW1

Description: SATA HDD Power Connector

Connector Type: Onboard 4-pin wafer connector

Pin	Description
1	+5V
2	GND
3	GND
4	+12V

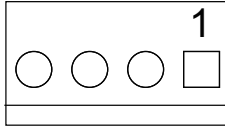

Board Top

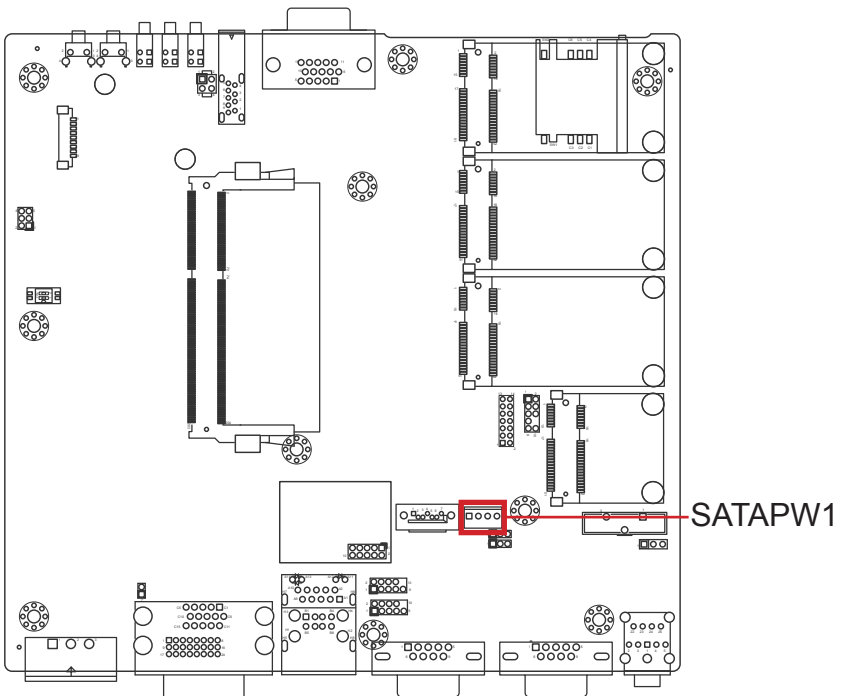

SATA1

Description: Serial ATA connectors for storage devices

Connector Type: 7-pin serial ATA connector

Pin	Description
1	GND
2	TX+
3	TX-
4	GND
5	RX-
6	RX+
7	GND

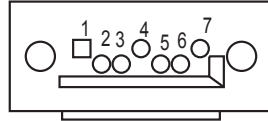

Board Top

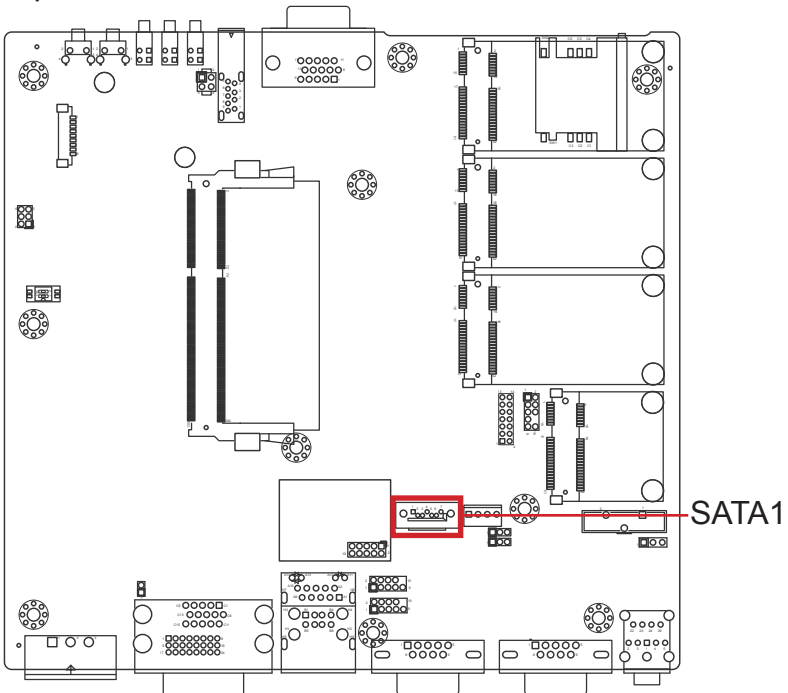

MC1 & MC2

Description: PCI Express Mini-card sockets

Connector Type: Onboard 0.8mm-pitch 52-pin edge card connector

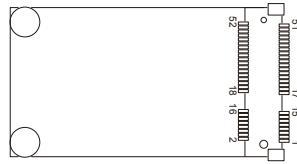

Pin Desc.	Pin Desc.	Pin Desc.	Pin Desc.
1 Wake	16 UIM_VPP	31 PETn0	43 GND
2 +3.3V	17 UIM_C8/Reserved	32 SMB_DATA	44 LED_WLAN#
3 COEX1	18 GND	33 PETp0	45 Reserved
4 GND	19 UIM_C4/Reserved	34 GND	46 LED_WPAN#
5 COEX2	20 W_Disable#	35 GND	47 Reserved
6 +1.5V	21 GND	36 USB_D-	48 +1.5V
7 CLKREQ#	22 PERST#	37 GND	49 Reserved
8 UIM_PWR	23 PERn0	38 USB_D+	50 GND
9 GND	24 +3.3V	39 +3.3V	51 Reserved
10 UIM_DATA	25 PERp0	40 GND	52 +3.3V
11 REFCLK-	26 GND	41 +3.3V	
12 UIM_CLK	27 GND	42 LED_WWAN#	
13 REFCLK+	28 +1.5V		
14 UIM_RESET	29 GND		
15 GND	30 SMB_CLK		

Board Top

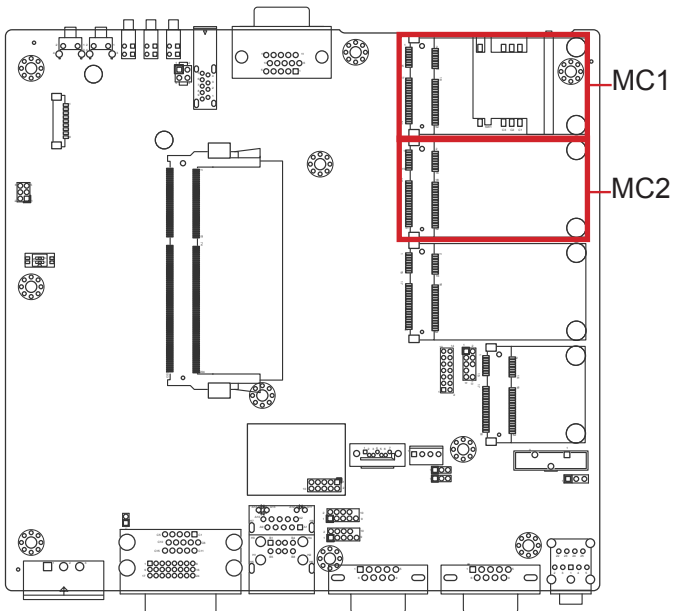

System Configuration

MC3

Description: PCI Express Mini-card socket
Connector Type: Onboard 0.8mm-pitch 52-pin edge card connector

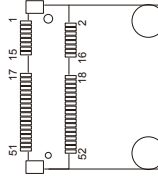

Pin Desc.	Pin Desc.	Pin Desc.	Pin Desc.
1 Wake	16 UIM_VPP	31 PETn0	42 LED_WWAN#
2 +3.3V	17 UIM_C8/Reserved	32 SMB_DATA	43 GND
3 COEX1	18 GND	33 PETp0	44 LED_WLAN#
4 GND	19 UIM_C4/Reserved	34 GND	45 Reserved
5 COEX2	20 W_Disable#	35 GND	46 LED_WPAN#
6 +1.5V	21 GND	36 USB_D-	47 Reserved
7 CLKREQ#	22 PERST#	37 GND	48 +1.5V
8 UIM_PWR	23 PERn0	38 USB_D+	49 Reserved
9 GND	24 +3.3V	39 +3.3V	50 GND
10 UIM_DATA	25 PERp0	40 GND	51 Reserved
11 REFCLK-	26 GND	41 +3.3V	52 +3.3V
12 UIM_CLK	27 GND		
13 REFCLK+	28 +1.5V		
14 UIM_RESET	29 GND		
15 GND	30 SMB_CLK		

Board Top

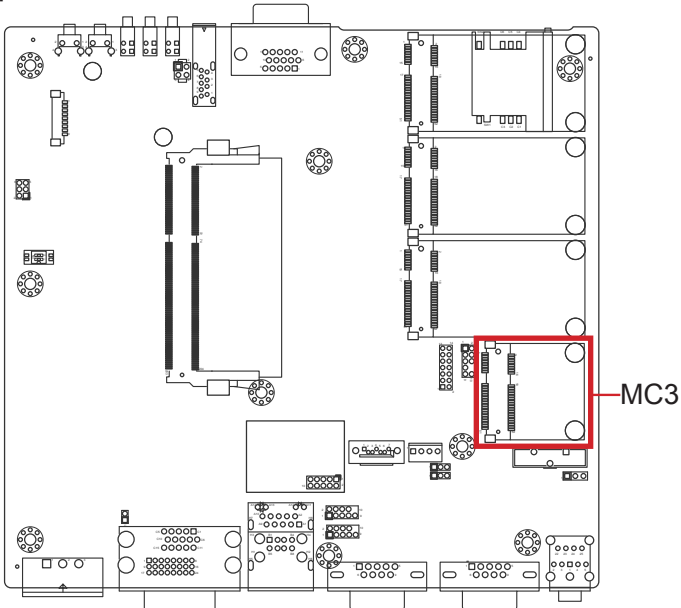

MSATA1

Description: mSATA socket
Connector Type: Onboard 0.8mm pitch 52-pin edge card connector

Pin	Desc.	Pin	Desc.	Pin	Desc.
1	NC	20	NC	36	NC
2	+3.3V	21	GND	37	GND
3	NC	22	NC	38	NC
4	GND	23	TX+	39	+3.3V
5	NC	24	+3.3V	40	GND
6	NC	25	TX-	41	+3.3V
7	NC	26	GND	42	NC
8	NC	27	GND	43	GND
9	GND	28	NC	44	NC
10	NC	29	GND	45	NC
11	NC	30	NC	46	NC
12	NC	31	RX-	47	NC
13	NC	32	NC	48	NC
14	NC	33	RX+	49	NC
15	GND	34	GND	50	GND
16	NC	35	GND	51	NC
17	NC			52	+3.3V
18	GND				
19	NC				

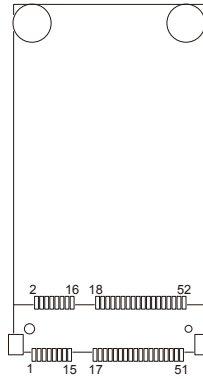

Board Top

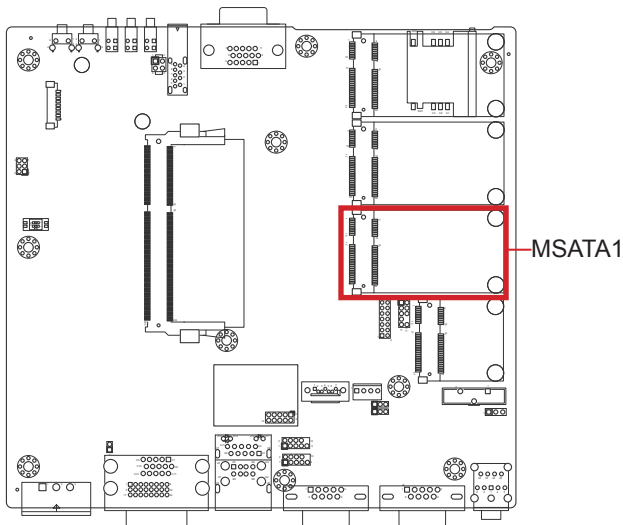

LAN1

Function: GbE Connector & Double-stacked USB ports

Connector type:

RJ-45 connector with LED & Double-stacked type-A USB 2.0 connectors

Pin	Description	Pin	Description
1	MDI0+	5	MDI2+
2	MDI0-	6	MDI2-
3	MDI1+	7	MDI3+
4	MDI1-	8	MDI3-

Pin	Description
1	5V
2	USB D-
3	USB D+
4	GND

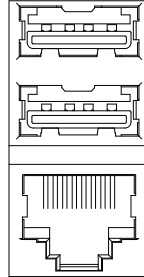

Board Top

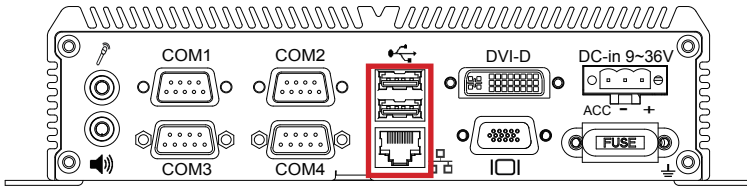

VGA1

Function: Analog RGB & DVI-D Connector

Connector type: Analog RGB (D-Sub 15-pin female type) + DVI-D (DVI-D female connector)

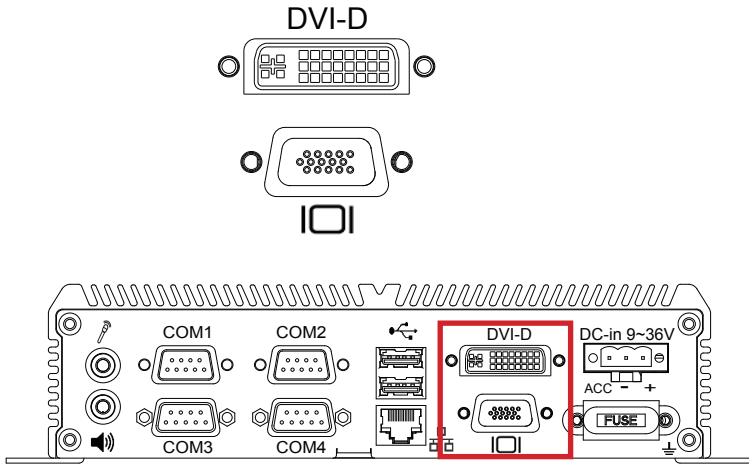

System Configuration

SIM1&2

Description: SIM card socket

Connector Type: 6-pin SIM card socket

Pin	Description	Pin	Description
C5	GND	C1	POWER VOLTAGE
C6	NC	C2	RESET SIGNAL
C7	I/O	C3	CLOCK SIGNAL

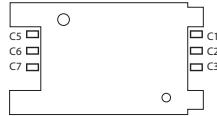

Board Top

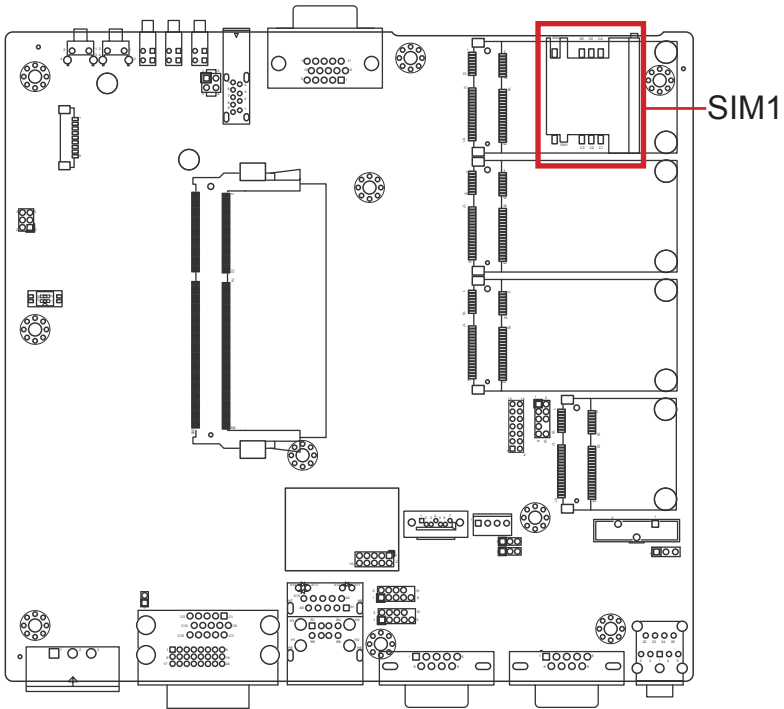

Board Bottom

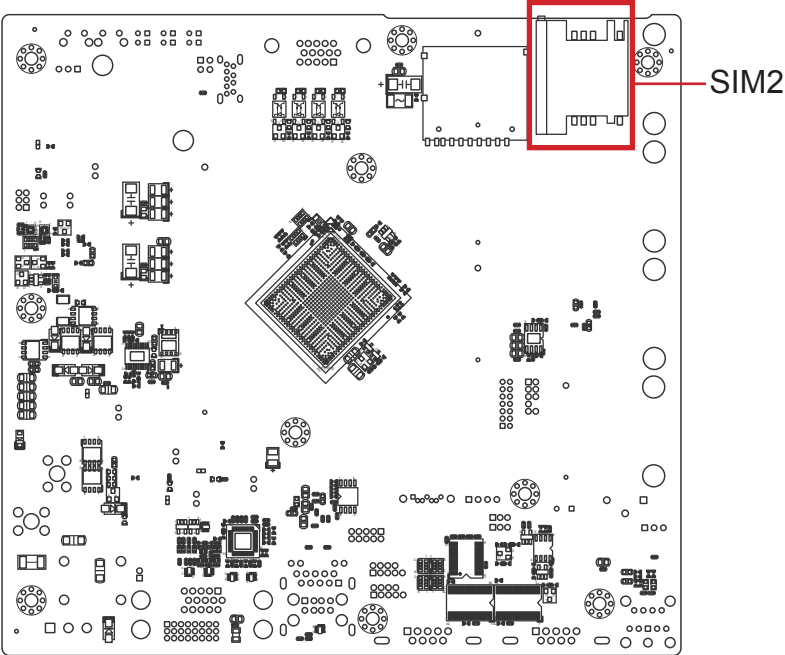

USB1

Function: USB 3.0 connector

Connector Type: USB 3.0/2/0 type-A connector

Pin Assignment: The pin assignments conform to the industry standard.

USB Flash/HDD are not supported by USB3.0 port but it works well with KB/MS

Board Top

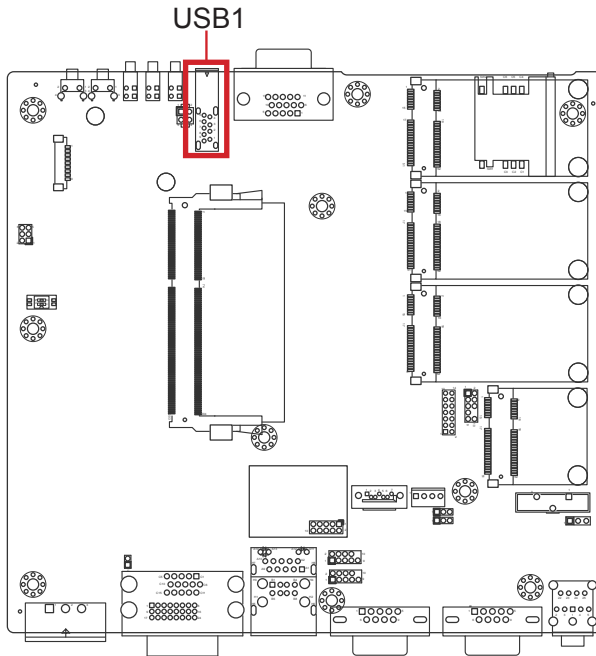

Chapter 4

Installation and Maintenance

4.1. Install Hardware

The computer is constructed based on modular design to make it easy for users to add hardware or to maintain the computer. The following sections will guide you to the simple hardware installations for the computer.

4.1.1. Open the Computer

All jumpers, connectors, and PCI Express Mini-card sockets are built on the carrier board. To access these components, the computer's top cover has to go. Follow through the steps below to remove the top cover from the computer.

1. Place the computer on a flat surface. Loosen and remove the screws from the bottom cover as marked in the illustration below.

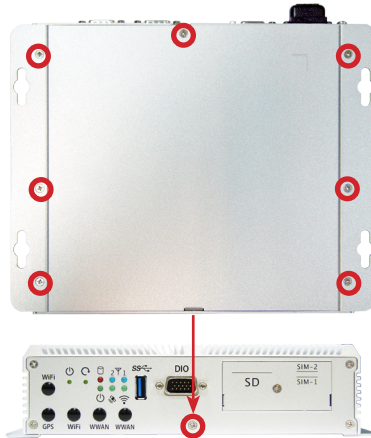

2. Dismount the bottom cover. The inside of the computer comes to view.



- ▶ To adjust jumpers or connect/disconnect devices to/from the carrier board, see [3.2.1. Jumpers](#) on page [16](#) and [3.2.2. Connectors](#) on page [20](#).

4.1.2. Install/uninstall SIM Card

The computer supports 2 SIM cards for mobile networking and comes with an outside-accessible SIM card slot. Follow through the guide below to install a SIM card to the computer.

To install a SIM card:

1. On the front panel of the computer, find the SIM card slot door. Loosen the screw to open it.



2. Use a clipper to press the eject button in the SIM card slot, and the SIM card jacket will be ejected. Pull the jacket out of the slot.



Installation & Maintenance

- Put the SIM card into the slot jacket as directed in the illustration below. Push-insert the SIM card into the slot.



Push-insert the SIM card.

To uninstall the SIM card:

- Use a clipper to press the eject button to eject the SIM card.
- Pull out the SIM card.
- Remove the SIM card jacket.
- Insert the card jacket into the slot.

4.1.3. Install SATA SSD

The ARTS-1450 supports one 2.5-inch SSD storage devices. To install a 2.5" SSD to the computer, follow through the guide below:

1. Open the Computer as instruction of [4.1.1. Open the Computer on page 40](#)
2. Locate the bracket inside the computer. Loose the screws and unplug the cable to remove the bracket.

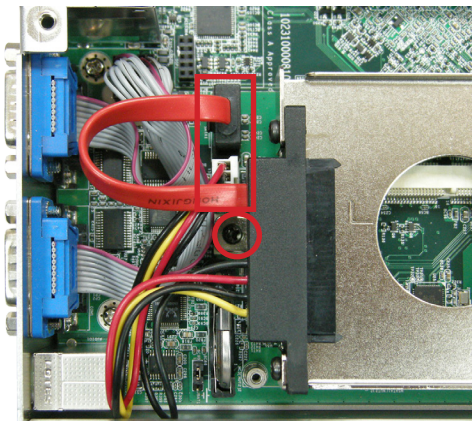
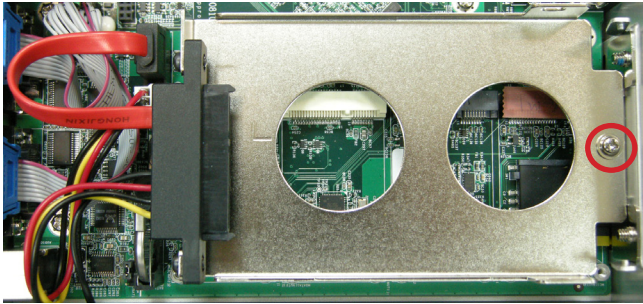

Installation & Maintenance

3. Insert the 2.5-inch SSD into the connector on the bracket.

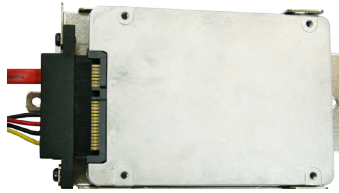

4. Fix the SSD with 2 screws.

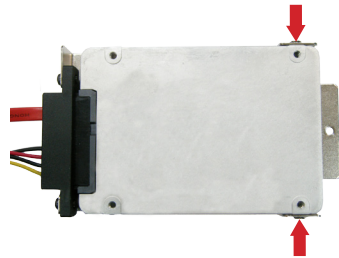

5. Put the bracket (with the SSD) back to the computer, plug cables and fasten screws.

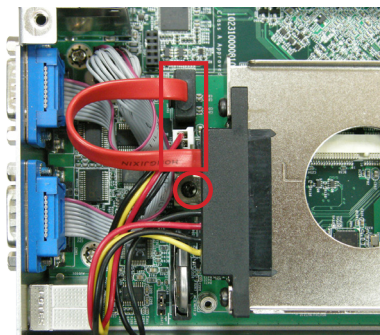
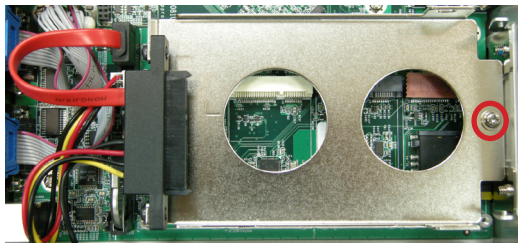

4.1.4. Disassemble SSD bracket

Before Wi-Fi/3G/mSATA module Installation, please remove the 2.5 SSD bracket.

1. Open the Computer as instruction of [4.1.1. Open the Computer on page 40](#).
2. Unplug the cables and loose the screws of 2.5 SSD bracket and remove it.

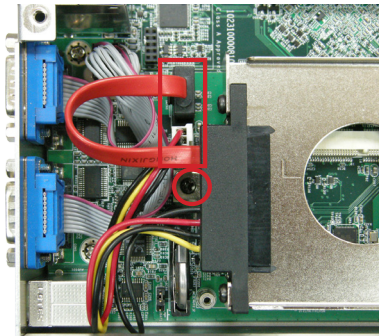
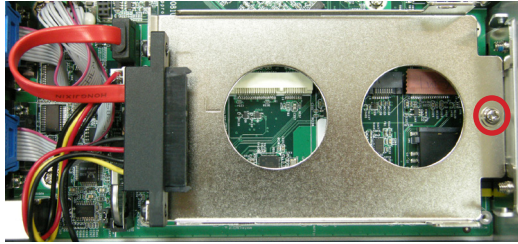

4.1.5. Install Memory Module on CPU Module

1. Open the computer as [4.1.1. Open the Computer](#)
2. Locate the Memory module slot and insert the memory module.

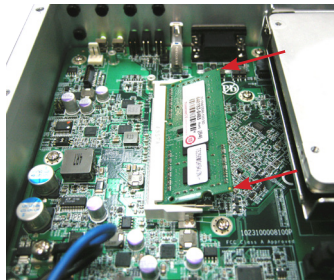
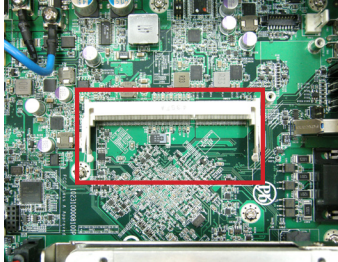

3. Assemble the bottom cover.

4.1.6. Insert a SD card

1. On the front panel of the computer, find the SD card slot door. Loose the screw to open it.



2. Slide the SD card into the slot. You can hear a slight clicking noise, which means it has locked into place.



4.2. Mount the Computer

Follow through the guide below to mount the computer to a wall.:

1. Find the four cutouts as marked in the illustration below:

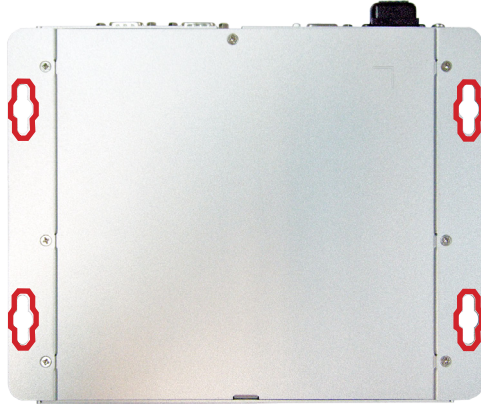

2. Mount the computer to a wall by the said cutouts.

4.3. Wire DC-in Power Source



Warning Only trained and qualified personnel are allowed to install or replace this equipment.

Follow the instructions below for connecting the computer to a DC-input power source.

4.31 Vehicle Application

For Vehicle Application, DC power Input wiring pin definition is as follow,

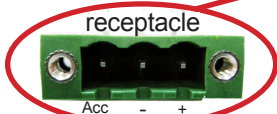

connect

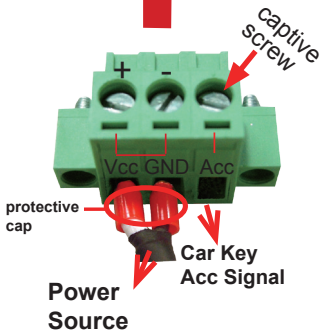

1. To turn on the Vehicle Acc for Vehicle application, please refer to Jumper setting of [JACON1 on page 49](#)
2. Before wiring, make sure the power source is disconnected.
3. Find the terminal block in the accessory box.
4. Use the wire-stripping tool to strip a short insulation segment from the output wires of the DC power source.
5. Identify the positive and negative feed positions for the terminal block connection. See the symbols printed on the rear panel indicating the polarities and DC-input power range in voltage.
6. Insert the exposed wires into the terminal block plugs. Only wires with insulation should extend from the terminal block plugs. Note the polarities between the wires and the terminal block plugs must be positive to positive and negative to negative.
7. Please connect the Acc pin with your car Acc, and the device will be activated when you turn your ignition key to Acc.
8. Use a slotted screwdriver to tighten the captive screws. Plug the terminal block firmly, which wired, into the receptacle on the rear panel.

4.3.2 Automation Application

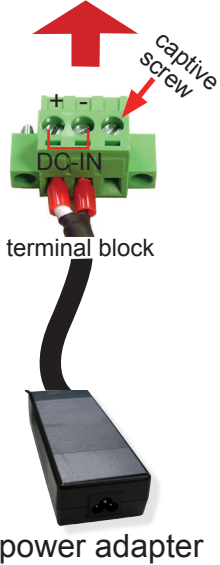
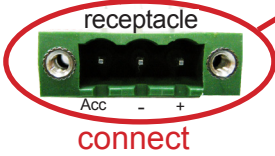

1. To turn off the Vehicle Acc for Automation application, please refer to Jumper setting of [JACON1 on page 49](#)
2. Before wiring, make sure the power source is disconnected.
3. Find the terminal block in the accessory box.
4. Use the wire-stripping tool to strip a short insulation segment from the output wires of the DC power source.
5. Identify the positive and negative feed positions for the terminal block connection. See the symbols printed on the rear panel indicating the polarities and DC-input power range in voltage.
6. Insert the exposed wires into the terminal block plugs. Only wires with insulation should extend from the terminal block plugs. Note the polarities between the wires and the terminal block plugs must be positive to positive and negative to negative.
7. Use a slotted screwdriver to tighten the captive screws. Plug the terminal block firmly, which wired, into the receptacle on the rear panel.

Chapter 5

BIOS

BIOS

The BIOS Setup utility for the computer is featured by American Megatrends Inc to configure the system settings stored in the system's BIOS ROM. The BIOS is activated once the computer powers on. When the computer is off, the battery on the main board supplies power to BIOS RAM.

To enter the BIOS Setup utility, keep hitting the “Esc” key upon powering on the computer.



The BIOS featured menus are:

Menu	Description
Main	See 5.1. Main on page 54 .
Advanced	See 5.2. Advanced on page 55 .
Security	See 5.3. Security on page 58
Power	See 5.4. Power on page 59
Boot	See 5.5. Boot on page 60
Exit	See 5.6. Exit on page 61 .

Key Commands

The BIOS Setup utility relies on a keyboard to receive user's instructions. Hit the following keys to navigate within the utility and configure the utility.

Keystroke	Function
← →	Moves left/right between the top menus.
↓ ↑	Moves up/down between highlight items.
Enter	Selects an highlighted item/field.
Esc	<ul style="list-style-type: none"> ▶ On the top menus: Use Esc to quit the utility without saving changes to CMOS. (The screen will prompt a message asking you to select OK or Cancel to exit discarding changes. ▶ On the submenus: Use Esc to quit current screen and return to the top menu.
F5	Increases current value to the next higher value or switches between available options.
F6	Decreases current value to the next lower value or switches between available options.
F1	Opens the Help of the BIOS Setup utility.
F9	Restore the Setup Default (The screen then prompts a message asking you to select OK or Cancel to restore to default.)
F10	Exits the utility saving the changes that have been made. (The screen then prompts a message asking you to select OK or Cancel to exit saving changes.)

Note: Pay attention to the "WARNING" that shows at the left pane onscreen when making any change to the BIOS settings.

This BIOS Setup utility is updated from time to time to improve system performance and hence the screenshots hereinafter may not fully comply with what you actually have onscreen.

5.1. Main

The **Main** menu features the settings of **System Date** and **System Time** and displays some BIOS info and system info.

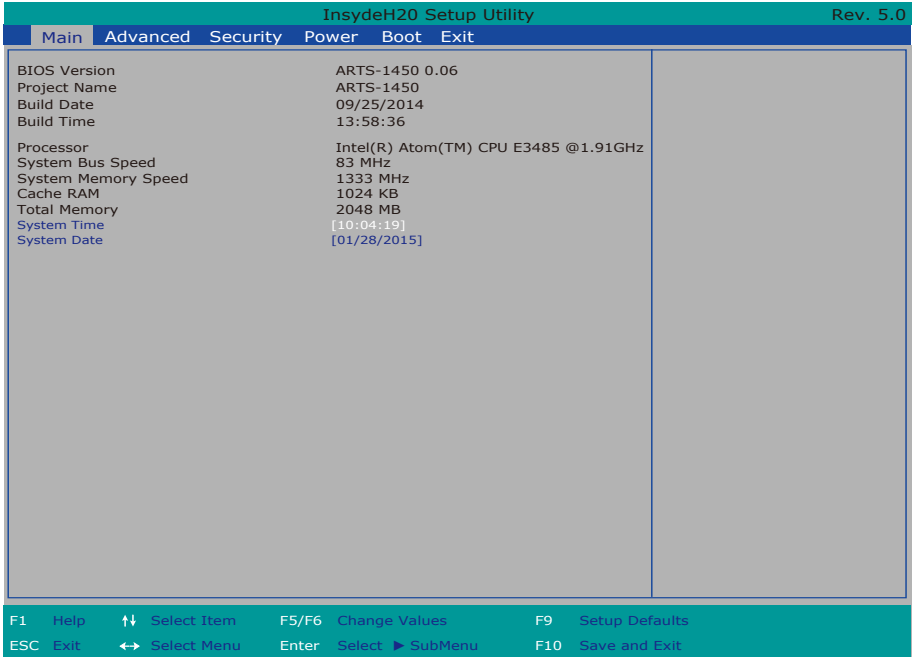

The BIOS info displayed are:

Info	Description
BIOS Version	Delivers the computer's BIOS version.
Processor Type	CPU and System BUS Information
RAM info	System Memory Speed, Cache RAM, Total Memory.

The featured settings are:

Setting	Description
System Time	Sets system time.
System Date	Sets system date.

5.2. Advanced

Access the **Advanced** menu to manage the computer's system configuration including the Super IO chip.

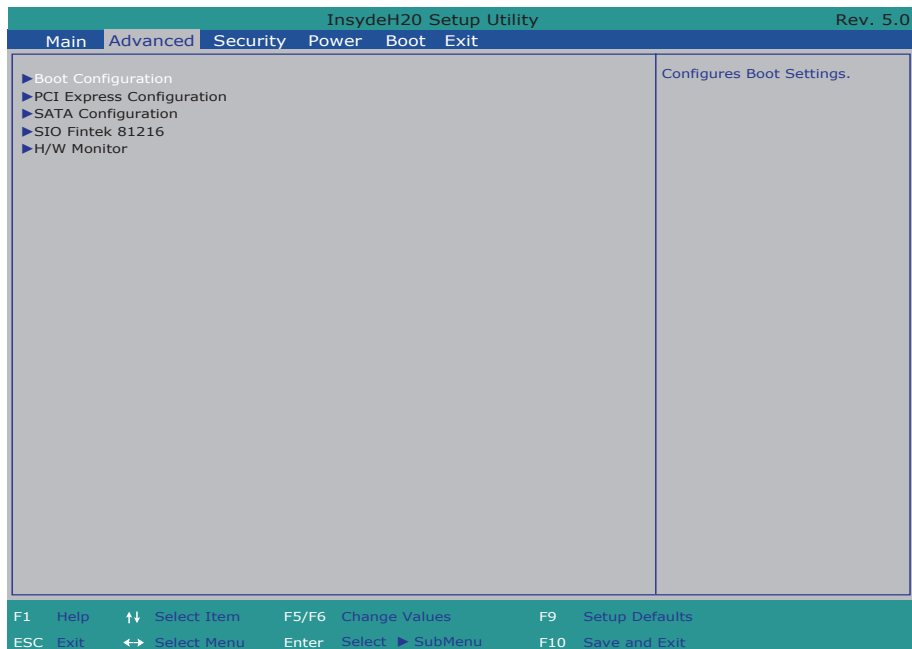

The featured settings and submenus are:

Setting	Description
Boot Configuration	See 5.2.1. Boot Configuration on page 56 .
PCI Express Configuration	See 5.2.2. PCI Express Configuration on page 56 .
SATA Configuration	See 5.2.3. SATA Configuration on page 56 .
SIO Fintek 81216	See 5.2.4. SIO Fintek 81216 on page 57 .
H/W Monitor	See 5.2.5. H/W Monitor on page 57 .

5.2.1. Boot Configuration

Setting	Description
Numlock	Select Power-on state for Num lock

5.2.2. PCI Express Configuration

Configures PCI Express by the following settings:

Setting	Description
PCI Express Root Port 1/2/3/4	<ul style="list-style-type: none"> ▶ PCI Express Root Port Enables/disables this PCIe port. ▶ PCIE Port 1/2/3/4 Speed Options are: Auto, Gen 1, Gen 2 Auto is the default. ▶ PCIE Port 1/2/3/4 ASPM Options are: Disable : disables ASPM L0s : force all links to L0s state L1 : force all links to L1 state L0sL1 : force all links to L0s+L1 state Auto : BIOS auto configure

5.2.3. SATA Configuration

Select this submenu to configure the SATA controller.

Setting	Description
SATA Controller(s)	Enables/disables the present SATA controller. ▶ Enabled is the default.
Chipset SATA Mode	Configures how to run the SATA drives. ▶ Options available are AHCI (default) and IDE .
SATA Speed	Configures SATA Speed ▶ Options are: Gen 1, Gen 2
Serial ATA Port 0	Delivers the SATA port Media information
Serial ATA Port 1	

5.2.4. SIO Fintek 81216

This submenu configures the computer's Super IO chip, Fintek F81216, for the serial port 1~4.

Setting	Description
Serial Port 1, 2	Enable (default) or Disable Serial Port (COM)
Base I/O Address	Set the Base I/O address of Serial port
Interface	Set the mode of Serial port. Options: RS232 (default) RS485
Interrupt	Set the interrupt of Serial port
Serial Port 3, 4	Enable (default) or Disable Serial Port (COM)
Base I/O Address	Set the Base I/O address of Serial port
Interrupt	Set the interrupt of Serial port

5.2.5. H/W Monitor

H/W Monitor monitors the systems' hardware status. Select H/W Monitor to run a health report of the computer that includes the info of CPU temperature, system temperature, VCC, VCORE and so on..

5.3. Security

The **Security** menu sets up the password for the system's supervisor account. Once the supervisor password is set up, this BIOS Setup utility is limited to access and will ask for the password each time any access is attempted.

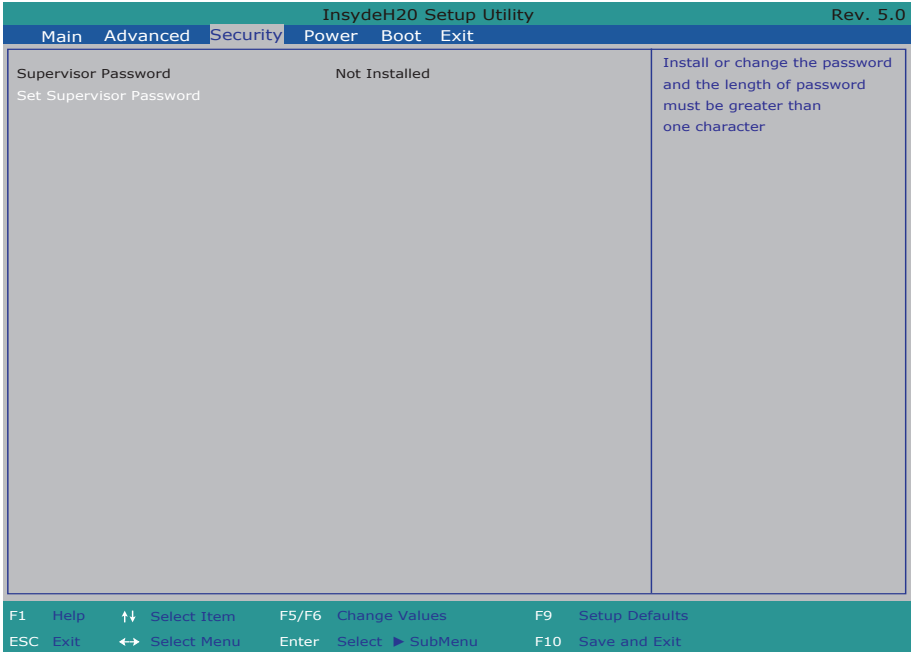

The featured setting is:

Setting	Description
Set Supervisor Password	<p>To set up an administrator password:</p> <ol style="list-style-type: none"> 1. Select Set Administrator Password. An Set Administrator Password dialog then pops up onscreen. 2. Enter your desired password that is no less than 3 characters and no more than 20 characters. 3. Hit [Enter] key to submit.

5.4. Power

The Power menu sets up the power option of system

InsydeH20 Setup Utility		Rev. 5.0			
Main	Advanced	Security	Power	Boot	Exit
Wake on PME			<Disabled>		Determines the action taken when the system power is off and a PCI Power Management Enable wake up event occurs.
State After G3			<S5 State>		
Power Delay Function			<Enable>		
Power on delay			<04 Seconds>		
Power off delay			<Manually Operator>		
Wake system from S5			<Disabled>		
F1 Help	↑↓ Select Item	F5/F6 Change Values	F9 Setup Defaults		
ESC Exit	←→ Select Menu	Enter Select ▶ SubMenu	F10 Save and Exit		

Setting	Description
Wake on PME	Enables or disables Wake on PME. Determines the action taken when the system power is off and a PCI Power Management Enable wake up event occurs.
State After G3	Set the state of System when power is re-applied after a Power failure (G3 state) ▶ Options are S0 State/S5 State(default)
Power Delay Function	Sets the system support power delay function. Enable (default) or Disable the power delay function.
Power on delay	Select the time which the system will power on ▶ Options are Manually Operator/04 Seconds(default)/08 Seconds/16 Seconds
Power off delay	Select the time which the system will shutdown ▶ Options are Manually Operator(default)/30 Seconds/60 Seconds/90 Seconds
Wake system from S5	Enables or disables system wake on alarm event. When enabled, system will wake on the hr::min::sec specified.

5.5. Boot

The **Boot** menu configures how to boot up the system such as the configuration of boot device priority.

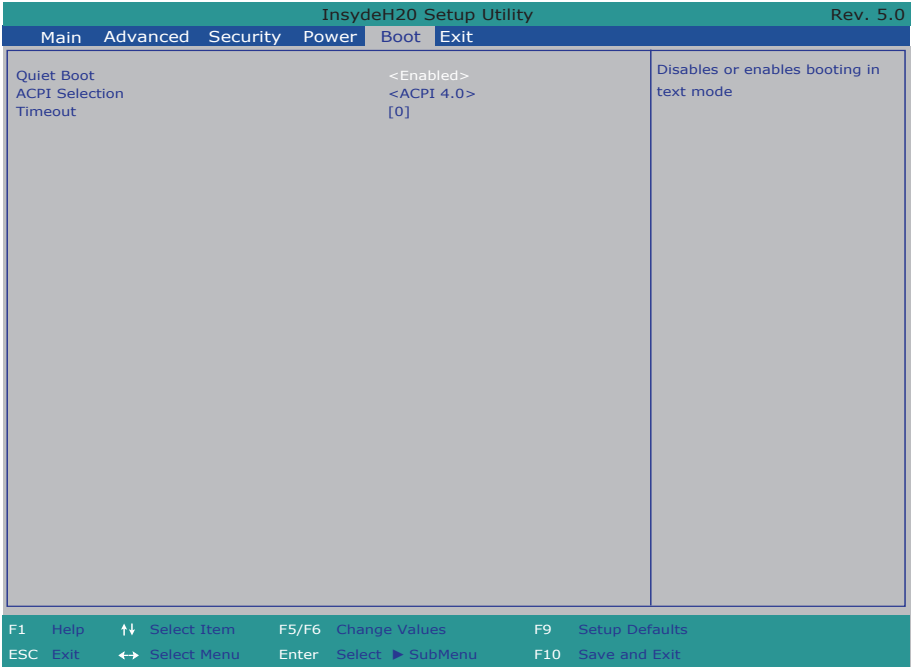

The featured settings are:

Setting	Description
Quiet Boot	Enables or disables booting in text mode.
APCI Selection	Select boot to Acpi 3.0/Acpi 1.0B Options are Acpi 1.0B/Acpi 3.0/Acpi 4.0/Acpi 5.0
Timeout	Set the waiting seconds before booting the default boot selection

5.6. Exit

The **Exit** menu features a handful of commands to launch actions from the BIOS Setup utility regarding saving changes, quitting the utility and recovering defaults.

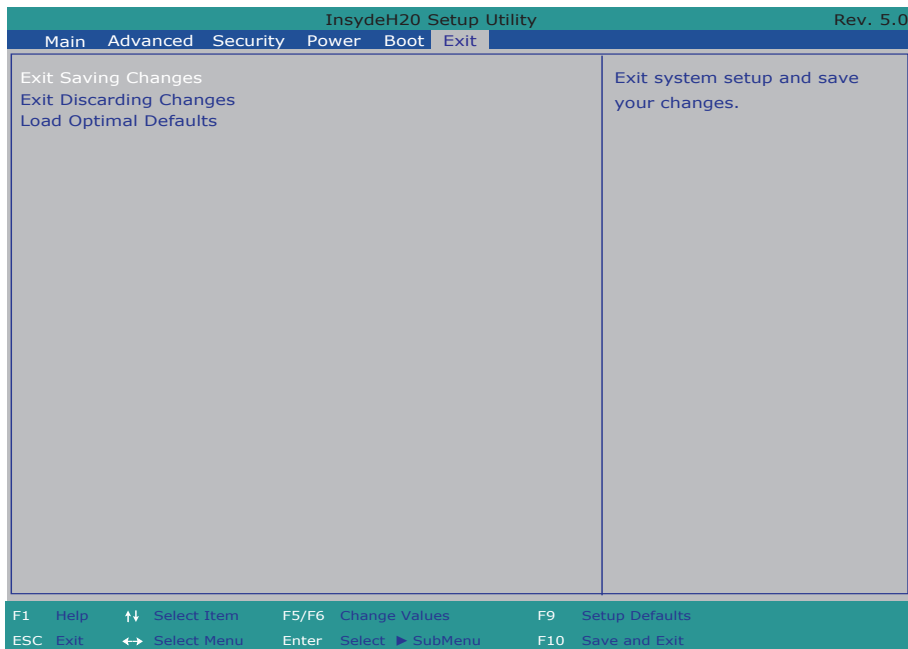

The features settings are:

Setting	Description
Exit Saving Changes	Exit system setup after saving the changes. ▶ Enter the item and then a dialog box pops up: Exit Saving Changes?
Exit Discarding Changes	Exit system setup without saving any changes. ▶ Enter the item and then a dialog box pops up: Exit Discarding Changes?
Load Optimal Defaults	Restore/Load Default values for all the setup options. ▶ Enter the item and then a dialog box pops up: Load Optimized Defaults?

This page is intentionally left blank.

Appendices

Appendix A: HSPA-1450 Hardware Installation

To be able to network with 3G, hardware-wise the computer needs a 3G module installed and a SIM card inserted. This appendix will guide you to install the 3G module **HSPA-1450**.

1. Remove the computer's bottom cover as described in [4.1.1. Open the Computer](#) on page [40](#).

The inside of the computer comes to view.



2. To remove the SSD bracket, please refer to [4.1.4. Disassemble SSD bracket on page 45](#)
3. Find the two **PCI Express Mini-card** sockets for a 3G module. MC1 is paired with SIM1, and MC2 is paired with SIM2.

Two Mini PCIe
card sockets

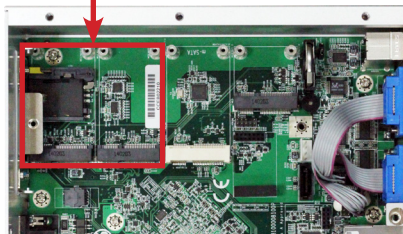

The socket has a break among the connector .

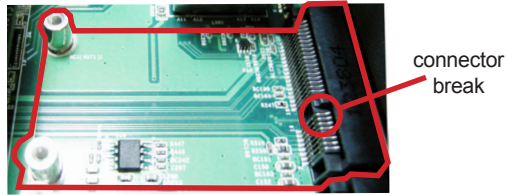

Mini-card socket

4. Have the **HSPA-1450** 3G module kit. The 3G module is a full-size module of **PCI Express Mini-card** form factor, with two U.FL connectors, one is “ANT1”, and the other is “ANT2”.

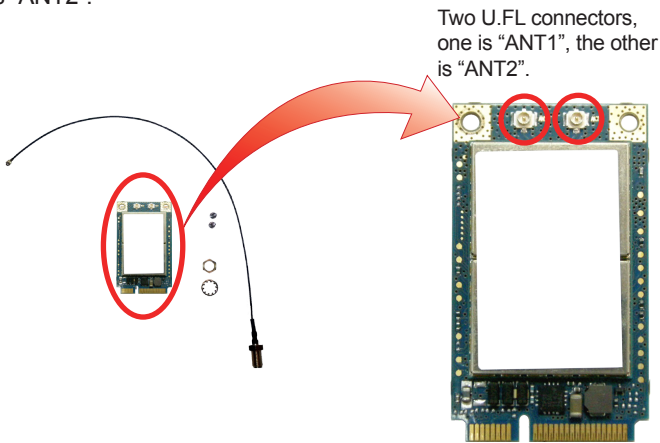

5. Plug the 3G module to the socket's connector by a slanted angle. Fully plug the module, and note the notch on the wireless module should meet the break of the connector.

Caution: Please unfasten the SIM card door screw before install any module on MC1 slot.



Fully plug the module.

6. Press down the module and fix the module in place using two screws.

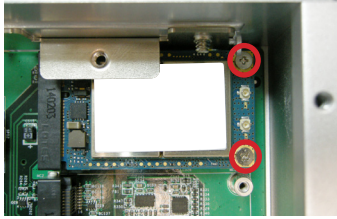

7. Have the RF antenna. The antenna has an SMA connector on one end and an MHF connector on the other.

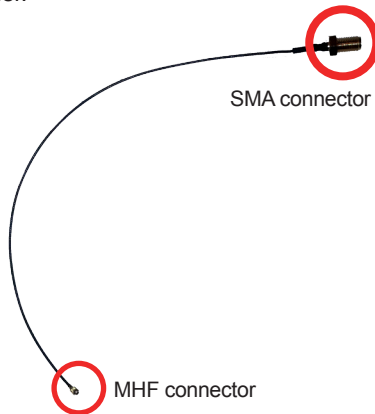

8. Connect the RF antenna's MHF connector to the 3G module's "ANT1" connector.

Connect the RF antenna's MHF connector to the 3G module's "ANT1" connector.

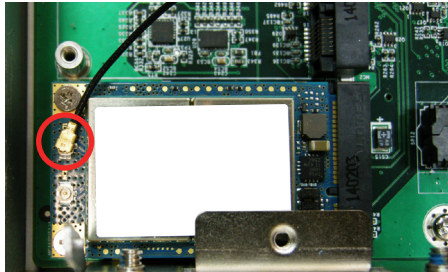

- Remove one plastic plug from the computer's front panel to make an antenna hole. Keep the plastic plug for any possible restoration in the future.

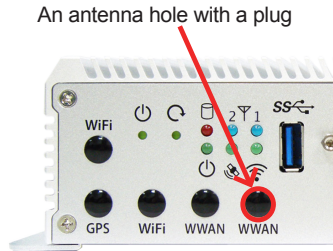

- From the other end of the RF antenna, which is an SMA connector, remove the washer and the nut. Save the washer and nut for later use. Note the SMA connector has the form of a threaded bolt, with one flattened side.

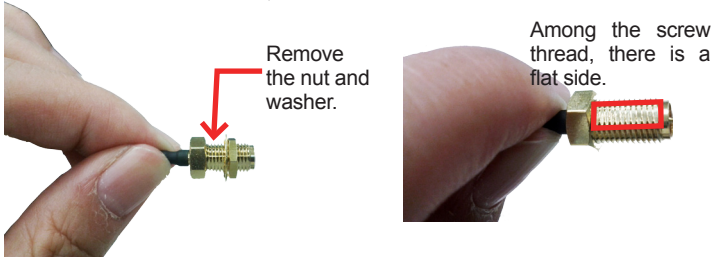

- Pull the SMA connector through the above mentioned antenna hole. Note to meet the aforesaid flattened side with the antenna hole's flat side.

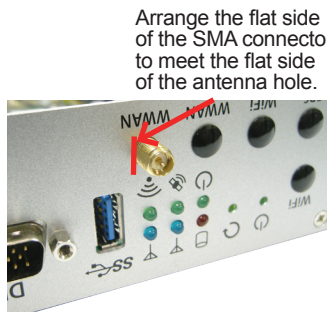

Appendices

12. Mount the washer first and then the nut to the SMA connector. Make sure the nut is tightened.



Mount the washer and the nut to the SMA connector. Tighten the nut.

13. Have an external antenna. Screw and tightly fasten the antenna to the SMA connector.



14. Assemble the bottom cover.

Appendix B: WIFI-AT2350 Hardware Installation

To use Wi-Fi, hardware-wise the computer needs a Wi-Fi module installed. This appendix will guide you to install the Wi-Fi module **WIFI-AT2350**.

1. Remove the computer's bottom cover as described in [4.1.1. Open the Computer](#) on page [40](#).

The inside of the computer comes to view.

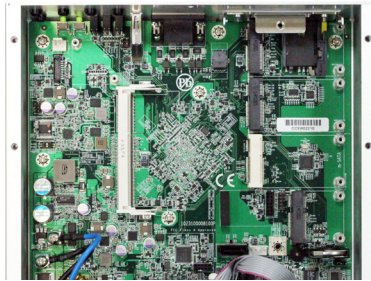

2. To remove the SSD bracket, please refer to [4.1.4. Disassemble SSD bracket on page 45](#)
3. Find the **PCI Express Mini-card** socket (half size) for a WiFi module.

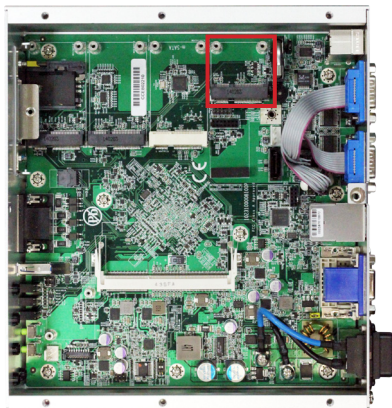

4. Prepare the **WIFI-AT2350** Wi-Fi module kit. The module is a half-size module of **PCI Express Mini-card** form factor, with two U.F.L connectors, one is "1", and the other is "0".

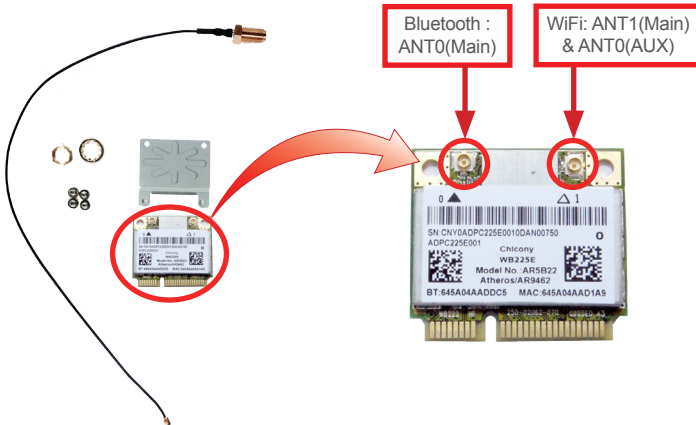

5. Plug the Wi-Fi module to the socket's connector by a slanted angle. Fully plug the module, and note the notch on the wireless module should meet the break of the connector.



6. Press down the module and fix the module in place using two screws.

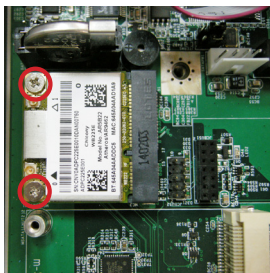

7. Have the RF antenna. The antenna has an SMA connector on one end and an MHF connector on the other.

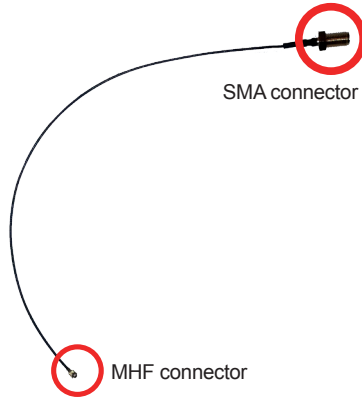

8. Connect the RF antenna's MHF connector to the Wi-Fi module's "MAIN" connector.

Connect the RF antenna's MHF connector to the Wi-Fi module's "1" connector.



9. Remove one plastic plug from the computer's front panel to make an antenna hole. Keep the plastic plug for any possible restoration in the future.



Appendices

- From the other end of the RF antenna, which is an SMA connector, remove the washer and the nut. Save the washer and nut for later use. Note the SMA connector has the form of a threaded bolt, with one flat side.

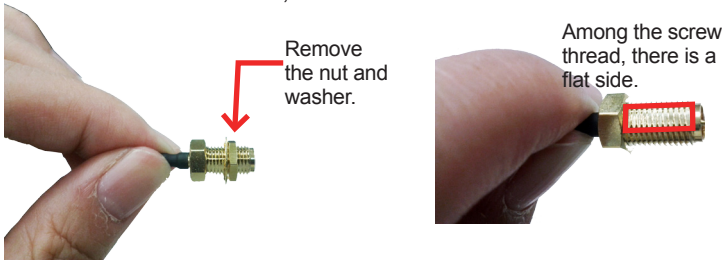

- Pull the SMA connector through the above mentioned antenna hole. Note to meet the aforesaid flattened side with the antenna hole's flat side.

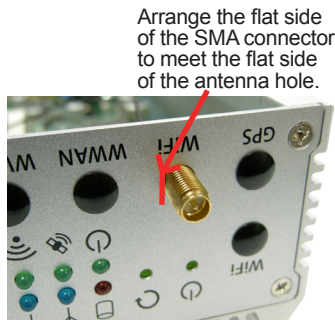

- Mount the washer first and then the nut to the SMA connector. Make sure the nut is tightened.

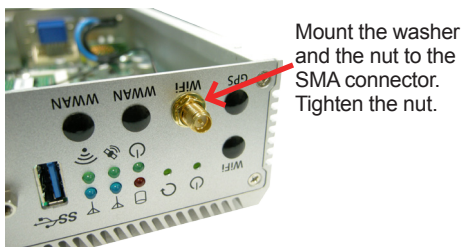

13. Have an external antenna. Screw and tightly fasten the antenna to the SMA connector.



Appendix C: GPS Module Hardware Installation

1. GPS Module kit is consist of GPS module, 2 screws, and one cable.

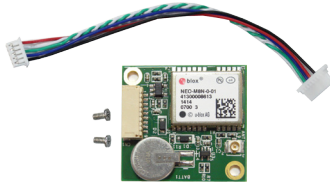

2. Remove the computer's bottom cover as described in [4.1.1. Open the Computer](#) on page [40](#).
3. Locate the GPS screw hole on the mainboard

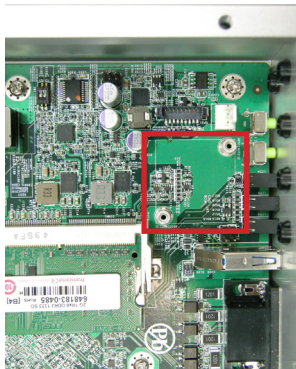

4. Fasten 2 screws to fix the module and connect the cable to the connector on the module.

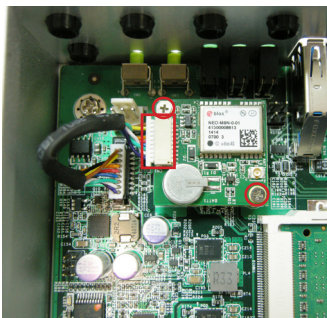

5. Have the RF antenna. The antenna has an SMA connector on one end and an MHF connector on the other.

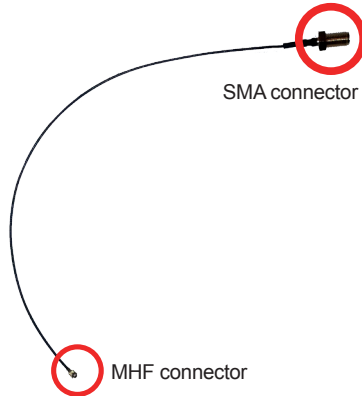

6. Connect the RF antenna's MHF connector to the GPS module's "ANT1" connector.

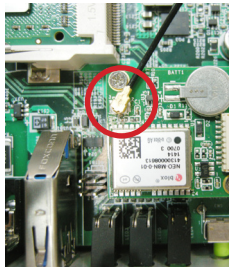

7. From the other end of the RF antenna, which is an SMA connector, remove the washer and the nut. Save the washer and nut for later use. Note the SMA connector has the form of a threaded bolt, with one flat side.

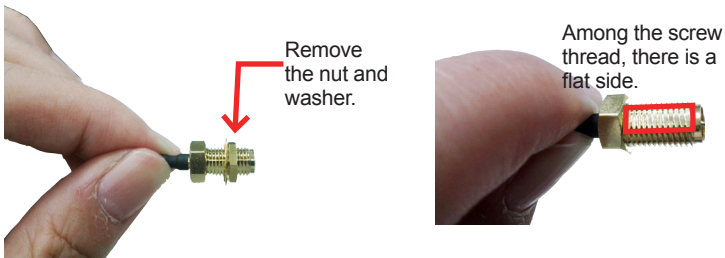

- Pull the SMA connector through the above mentioned antenna hole. Note to meet the aforesaid flattened side with the antenna hole's flat side.

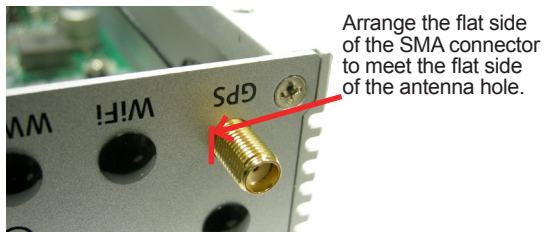

- Mount the washer first and then the nut to the SMA connector. Make sure the nut is tightened.

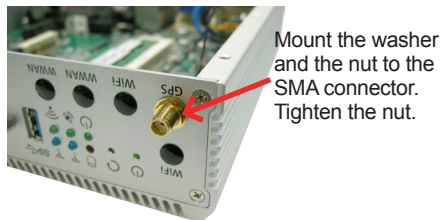

- Have an external antenna. Screw and tightly fasten the antenna to the SMA connector.

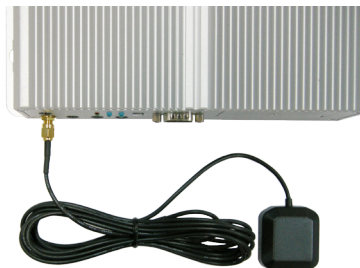

Appendix D: CANBUS Module Hardware Installation

1. CANBUS Module kit is consist of CANBUS module, one rubber, and one cable.

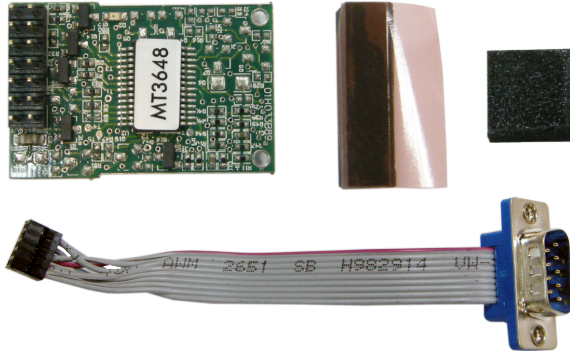

2. Remove the computer's bottom cover as described in [4.1.1. Open the Computer](#) on page [40](#).
3. Locate the CANBUS connector on the main board

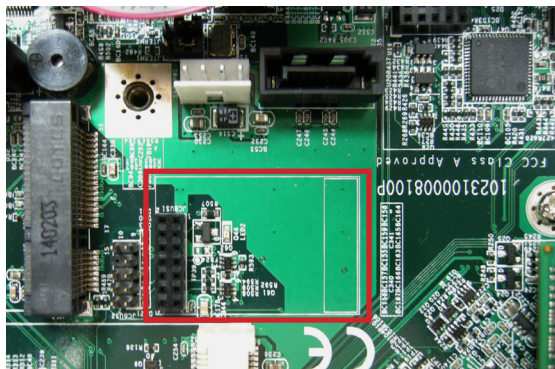

4. Remove the tap on the rubber and attach the rubber to the main board as shown.

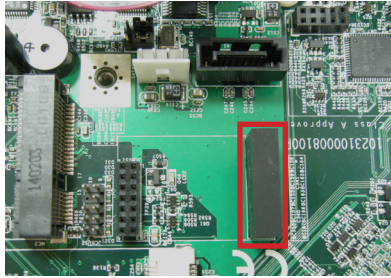

5. Insert the CANBUS module into the connector.

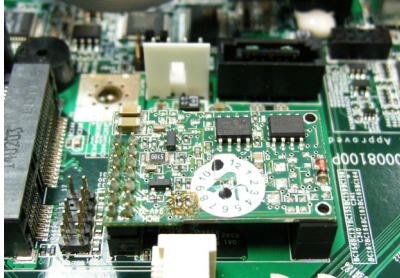

6. Plug the CANBUS cable into the connector.

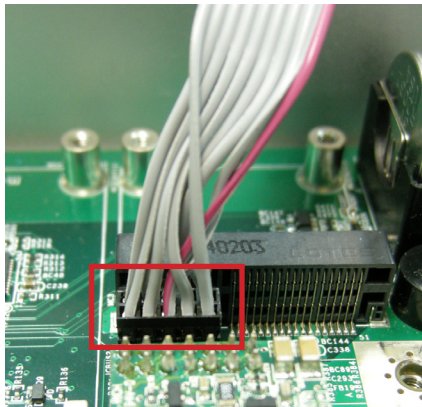

7. Loosen the stand-out hex screws of the COM3 or COM4 to remove the D-Sub connector.

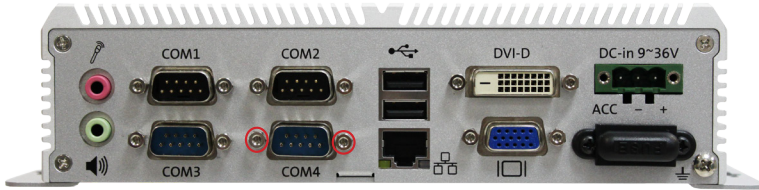

8. Pull the D-Sub connector through the D-Sub hole and fix it with the stand-off hex screws.

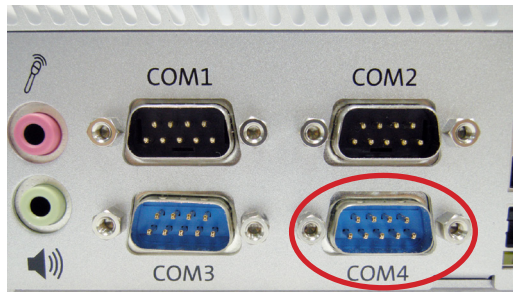

9. Attach one rubber to the SSD bracket to protect the canbus board.

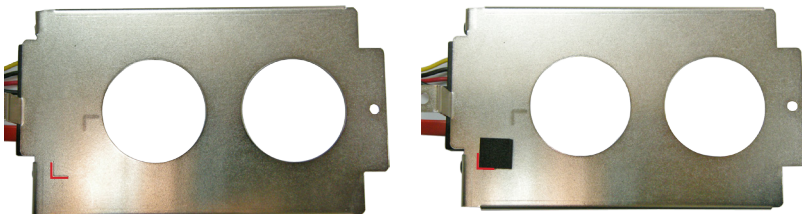

10. Restore the bottom cover.